

# T24 Wireless User Manual

800loadcel.com



## T24

Wireless Telemetry

<b>Introduction / Overview</b> .....	<b>16</b>
<b>Navigating This Manual</b> .....	<b>16</b>
<b>Product Quick Locator</b> .....	<b>16</b>
<b>T24 Telemetry Basic Principles</b> .....	<b>17</b>
Transmitters & Receivers .....	17
Transmitters.....	17
Receivers.....	17
Radio Channel and Group Key .....	17
Radio Channel .....	17
Group Key.....	17
Configuring Multiple Modules to Use the Same Radio Settings.....	18
ID and Data Tags.....	18
Transmitter Module Modes of Operation.....	18
Normal.....	18
Configuration.....	18
Sleep.....	18
Transmitter Module Sleep Delay Settings.....	19
Pairing .....	19
Pairing From T24 Toolkit.....	19
Pairing From a Receiver Module .....	19
Soft Pairing.....	20
Configuring an Attached Base Station .....	20
Asynchronous Operation and Logging.....	20
Bandwidth.....	21
Repeaters and Repeater Subgroups .....	21
<b>T24 Toolkit</b> .....	<b>22</b>
<b>Common Toolkit Pages</b> .....	<b>23</b>
Setup Base Station Communications.....	23
Analyser .....	24
Channel Monitor .....	25
Home .....	27
Connecting to a remote module.....	27
Connecting to the attached base station module .....	28
Manual Connection .....	28
Information.....	29
Battery and Radio Levels.....	30
Battery and Radio Levels Advanced .....	31
Radio Settings .....	32
Radio Settings Advanced.....	33
Save and Restore .....	34
<b>Transmitter Modules</b> .....	<b>35</b>
T24-ACM-SA, T24-ACMi-SA, T24-ACMm-SA, T24-SAe, T24-SAi.....	35
Overview .....	35
Order Codes .....	35
T24-SAe .....	35
T24-SAi.....	35
T24-ACM-SA.....	35
T24-ACMi-SA.....	35
T24-ACMm-SA.....	35
Connections.....	36
T24-SAe, T24-SAi .....	36
Power .....	36
Sensor.....	36
T24-ACM-SA.....	37
Power.....	37
Sensor.....	37

T24-ACMi-SA .....	38
Power .....	38
Sensor .....	38
T24-ACMm-SA .....	39
Power .....	39
Connecting T24-BB1 .....	39
Sensor .....	39
Using Completion Resistors.....	40
<b>Full Bridge</b> .....	40
<b>Half Bridge</b> .....	40
Quarter Bridge.....	40
Strain Element in Compression .....	40
Strain Element in Tension.....	40
Shield Connections (All Enclosures).....	41
Configuration.....	42
Data Rates and Quality.....	42
Calibration .....	44
Calibration by Certificate.....	46
Calibration Advanced.....	47
Advanced Settings.....	48
Enclosure & Mounting .....	49
T24-SAe, T24-SAi .....	49
T24-ACM-SA.....	49
T24-ACMi-SA.....	49
T24-ACMm-SA.....	49
Antennas.....	49
T24-SAi.....	49
T24-SAe .....	49
T24-ACM-SA, T24-ACMi-SA, T24-ACMm-SA .....	49
Specification .....	50
Radio Range.....	51
T24-ACM-SAf, T24-ACMi-SAf, T24-ACMm-SAf, T24-SAfe, T24-SAfi .....	52
Overview .....	52
Order Codes .....	52
T24-SAfe.....	52
T24-SAfi .....	52
T24-ACM-SAf .....	52
T24-ACMi-SAf .....	52
T24-ACMm-SAf .....	52
Connections.....	53
T24-SAfe, T24-SAfi .....	53
Power .....	53
Sensor .....	53
T24-ACM-SAf .....	54
Power .....	54
Sensor .....	54
T24-ACMi-SAf .....	55
Power .....	55
Sensor .....	55
T24-ACMm-SAf .....	56
Power .....	56
Connecting T24-BB1 .....	56
Sensor .....	56
Using Completion Resistors.....	57
<b>Full Bridge</b> .....	57
<b>Half Bridge</b> .....	57

Quarter Bridge.....	57
High Reference.....	57
Low Reference.....	57
Shield Connections (All Enclosures).....	58
Configuration.....	59
Battery Life.....	59
Zero Settings.....	61
Data Provider Monitor.....	62
Advanced Settings.....	63
Enclosure & Mounting.....	64
T24-SAFe, T24-SAFi.....	64
T24-ACM-SAf.....	64
T24-ACMi-SAf.....	64
T24-ACMm-SAf.....	64
Antennas.....	64
T24-SAFi.....	64
T24-SAFe.....	64
T24-ACM-SAf, T24-ACMi-SAf, T24-ACMm-SAf.....	64
Specification.....	65
Radio Range.....	65
T24-ACM-VA, T24-ACMi-VA, T24-ACMm-VA, T24-VAe, T24-VAi.....	66
Overview.....	66
Order Codes.....	66
T24-VAe.....	66
T24-VAi.....	66
T24-ACM-VA.....	66
T24-ACMi-VA.....	66
T24-ACMm-VA.....	66
Connections.....	67
T24-VAe, T24-VAi.....	67
Power.....	67
Sensor.....	67
T24-ACM-VA.....	68
Power.....	68
Sensor.....	68
T24-ACMi-VA.....	69
Power.....	69
Sensor.....	69
T24-ACMm-VA.....	70
Power.....	70
Connecting T24-BB1.....	70
Sensor.....	70
Shield Connections (All Enclosures).....	71
Configuration.....	72
Data Rates and Quality.....	72
Calibration.....	74
Calibration by Certificate.....	76
Calibration Advanced.....	77
Advanced Settings.....	78
Enclosure & Mounting.....	79
T24-VAe, T24-VAi.....	79
T24-ACM-VA.....	79
T24-ACMi-VA.....	79
T24-ACMm-VA.....	79
Antennas.....	80
T24-VAi.....	80

T24-VAe.....	80
T24-ACM-VA, T24-ACMi-VA, T24-ACMm-VA.....	80
Specification.....	81
Radio Range.....	81
T24-ACM-IA, T24-ACMi-IA, T24-ACMm-IA, T24-IAe, T24-IAi.....	82
Overview.....	82
Order Codes.....	82
T24-IAe.....	82
T24-IAi.....	82
T24-ACM-IA.....	82
T24-ACMi-IA.....	82
T24-ACMm-IA.....	82
Connections.....	83
T24-IAe, T24-IAi.....	83
Power.....	83
Sensor.....	83
T24-ACM-IA.....	83
Power.....	83
Sensor.....	84
T24-ACMi-IA.....	85
Power.....	85
Sensor.....	85
T24-ACMm-IA.....	86
Power.....	86
Connecting T24-BB1.....	86
Sensor.....	86
Shield Connections (All Enclosures).....	87
Configuration.....	88
Data Rates and Quality.....	88
Calibration.....	90
Calibration by Certificate.....	92
Calibration Advanced.....	93
Advanced Settings.....	94
Enclosure & Mounting.....	95
T24-IAe, T24-IAi.....	95
T24-ACM-IA.....	95
T24-ACMi-IA.....	95
T24-ACMm-IA.....	95
Antennas.....	96
T24-IAi.....	96
T24-IAe.....	96
T24-ACM-IA, T24-ACMi-IA, T24-ACMm-IA.....	96
Specification.....	97
Radio Range.....	97
T24-ACM-TA, T24-ACMi-TA, T24-ACMm-TA, T24-TAe, T24-TAi.....	98
Overview.....	98
Order Codes.....	98
T24-TAe.....	98
T24-TAi.....	98
T24-ACM-TA.....	98
T24-ACMi-TA.....	98
T24-ACMm-TA.....	98
Connections.....	99
T24-TAe, T24-TAi.....	99
Power.....	99
Sensor.....	99

2 Wire.....	99
3 Wire.....	99
4 Wire.....	100
T24-ACM-TA.....	100
Power.....	100
Sensor.....	100
T24-ACMi-TA.....	101
Power.....	101
Sensor.....	101
T24-ACMm-TA.....	101
Power.....	101
Connecting T24-BB1.....	102
Sensor.....	102
Shield Connections (All Enclosures).....	103
Configuration.....	104
Data Rates and Quality.....	104
Calibration.....	106
Advanced Settings.....	107
Enclosure & Mounting.....	108
T24-TAe, T24-TAi.....	108
T24-ACM-TA.....	108
T24-ACMi-TA.....	108
T24-ACMm-TA.....	108
Antennas.....	108
T24-TAi.....	108
T24-TAe.....	108
T24-ACM-TA, T24-ACMi-TA, T24-ACMm-TA.....	108
Specification.....	109
Radio Range.....	109
T24-ACM-RA, T24-ACMi-RA, T24-ACMm-RA, T24-RAe, T24RAi.....	110
Overview.....	110
Order Codes.....	110
T24-RAe.....	110
T24-RAi.....	110
T24-ACM-RA.....	110
T24-ACMi-RA.....	110
T24-ACMm-RA.....	110
Connections.....	111
T24-RAe, T24-RAi.....	111
Power.....	111
Sensor.....	111
T24-ACM-RA.....	111
Power.....	111
Sensor.....	112
T24-ACMi-RA.....	113
Power.....	113
Sensor.....	113
T24-ACMm-RA.....	114
Power.....	114
Connecting T24-BB1.....	114
Sensor.....	114
Shield Connections (All Enclosures).....	115
Configuration.....	116
Data Rates and Quality.....	116
Input / Output Configuration.....	118
Calibration by Certificate.....	120

Calibration Advanced.....	121
Advanced Settings.....	123
Enclosure & Mounting .....	124
T24-RAe, T24-RAi.....	124
T24-ACM-RA.....	124
T24-ACMi-RA .....	124
T24-ACMm-RA.....	124
Antennas.....	125
T24-RAi .....	125
T24-RAe.....	125
T24-ACM-RA, T24-ACMi-RA, T24-ACMm-RA .....	125
Specification .....	126
Radio Range.....	126
T24-ACM-PA, T24-ACMi-PA, T24-ACMm-PA, T24-PAe, T24-PAi .....	127
Overview .....	127
Order Codes .....	127
T24-PAe .....	127
T24-PAi .....	127
T24-ACM-PA.....	127
T24-ACMi-PA.....	127
T24-ACMm-PA.....	127
Connections.....	128
T24-PAe, T24-PAi .....	128
Power .....	128
Sensor .....	128
Relay & Volt Free Contact.....	129
Voltage Source .....	129
NPN Open Collector.....	129
T24-ACM-PA.....	129
Power .....	129
Sensor .....	130
T24-ACMi-PA.....	131
Power .....	131
Sensor .....	131
T24-ACMm-PA.....	132
Power .....	132
Connecting T24-BB1 .....	132
Sensor .....	132
Shield Connections (All Enclosures) .....	133
Configuration.....	134
Data Rates and Quality.....	134
Input / Output Configuration .....	136
Advanced I/O .....	137
Custom Output Type.....	137
Advanced Settings.....	138
Enclosure & Mounting .....	139
T24-PAe, T24-PAi .....	139
T24-ACM-PA.....	139
T24-ACMi-PA.....	139
T24-ACMm-PA.....	139
Antennas.....	140
T24-PAi .....	140
T24-PAe.....	140
T24-ACM-PA, T24-ACMi-PA, T24-ACMm-PA.....	140
Specification .....	141
Radio Range.....	141

T24-WSS .....	142
Overview .....	142
Order Codes .....	142
T24-WSS .....	142
Connections.....	143
Power .....	143
Configuration.....	143
Data Rates and Quality.....	144
Units.....	146
Advanced Settings.....	147
Enclosure & Mounting .....	148
Antennas.....	148
Specification .....	149
Radio Range.....	149
<b>Receiver Modules .....</b>	<b>150</b>
T24-HS.....	150
Overview .....	150
Order Codes .....	150
T24-HS.....	150
Connections.....	150
Power .....	150
Quick Start.....	151
Connecting Power .....	151
T24-HS.....	151
Transmitter Module .....	151
Pairing .....	151
Operation.....	152
Keys .....	152
Modes.....	152
Indicators.....	152
Errors.....	152
Configuration.....	154
Zero Settings .....	155
Display Format.....	157
Display Format Advanced Settings.....	158
Advanced Settings.....	159
Enclosure & Mounting .....	161
Antennas.....	161
Specification .....	162
Radio Range.....	162
T24-HA .....	163
Overview .....	163
Order Codes .....	163
T24-HA .....	163
Connections.....	163
Power .....	163
Operation .....	164
Item Mode.....	164
Keys .....	164
Result Mode.....	165
Keys when viewing Result.....	165
Keys when viewing an individual item .....	165
All Modes.....	167
Indicators.....	167
Errors .....	167
Other Functions.....	167



Configuration.....	168
Mode and Communications.....	168
Prompts.....	170
Zero Settings.....	171
Zero Settings Advanced.....	173
Display Format.....	174
Display Format Advanced Settings.....	176
Advanced Settings.....	177
Enclosure & Mounting.....	179
Antennas.....	179
Specification.....	180
Radio Range.....	180
T24-HR.....	181
Overview.....	181
Order Codes.....	181
T24-HR.....	181
Connections.....	181
Power.....	181
Operation.....	182
View readings.....	182
Keys.....	182
Indicators.....	182
Errors.....	183
Special Modes.....	183
Transmitter Module Configuration.....	184
Configuration.....	185
Display Format.....	185
Display Format Advanced Settings.....	187
Settings.....	188
Example Installation Scenarios.....	189
Scenario 1 – 200 transmitter modules are spaced at 1 meter intervals along a bridge.....	189
Scenario 2 – The operator has 3 rooms to monitor.....	189
Scenario 3 – 500 pallets are stored in a warehouse.....	189
Enclosure & Mounting.....	190
Antennas.....	190
Specification.....	191
Radio Range.....	191
T24-AO1, T24-AO1i.....	192
Overview.....	192
Order Codes.....	192
T24-AO1.....	192
T24-AO1i.....	192
Connections.....	193
Power.....	193
T24-AO1.....	193
T24-AO1i.....	193
Connections and Indicators.....	194
T24-AO1.....	194
T24-AO1i.....	194
Output Range Setting.....	194
LED Indicators.....	195
Configuration.....	196
T24 Toolkit.....	196
Input / Output.....	197
Alarm Settings.....	199
Zero Settings.....	201

Advanced Settings.....	202
Enclosure & Mounting.....	203
T24-AO1.....	203
T24-AO1i.....	203
Antennas.....	203
Specification.....	204
Radio Range.....	204
T24-RM1.....	205
Overview.....	205
Order Codes.....	205
T24-RM1.....	205
Connections.....	206
Power.....	206
Connections & Indicators.....	206
LEDs.....	206
Inputs.....	206
Operation.....	207
Configuration.....	208
Input Settings.....	208
Relay Operation Settings.....	209
Operation and Hysteresis Settings.....	210
Relay Settings Advanced.....	211
Alarm Settings.....	212
Enclosure & Mounting.....	213
Antennas.....	213
Specification.....	214
Radio Range.....	214
T24-SO.....	215
Overview.....	215
Order Codes.....	215
T24-SO.....	215
Connections.....	216
Power.....	216
Serial Settings.....	216
SW1 Settings.....	216
RS232.....	217
Example connection to a PC 9 way D serial connector.....	217
RS485.....	217
Example connection.....	217
Serial Limitations.....	217
Configuration.....	218
Getting Started.....	218
T24 Toolkit.....	219
Input Settings.....	219
Output Settings.....	221
Output Scaling.....	223
Output Design.....	224
Zero Settings.....	226
Zero Settings Advanced.....	227
Configuration Examples.....	228
LED Display from a Single Source.....	228
Summed LED Display from Dual Source.....	228
Print Gross Sum of Two Modules to Printer.....	229
Customer Ticket from Handheld Module.....	230
Enclosure & Mounting.....	230
Antennas.....	230

Specification .....	231
Radio Range.....	231
T24-GW1 .....	232
Overview .....	232
Order Codes .....	232
T24-GW1 .....	232
Connections.....	233
SW1 Settings .....	233
Baud Rate.....	233
Power.....	233
LED Indication .....	234
RS232.....	234
Example connection to a PC 9 way D serial connector.....	234
RS485.....	234
Example connection.....	234
Serial Limitations.....	235
Communications Overview.....	236
MODBUS Communication.....	236
Control Registers.....	236
Commands.....	236
Data Tag Holding Registers .....	237
Value & Status Registers.....	237
ASCII Communication .....	238
Commands.....	239
Configuration .....	240
General Settings.....	240
Define Inputs .....	242
Enclosure & Mounting .....	243
Antennas.....	243
Specification .....	244
Radio Range.....	244
T24-LD1 .....	245
Overview .....	245
Order Codes .....	245
T24-LD1 .....	245
Connections.....	246
Logic Input Connections.....	247
Logic Input Front Panel indicators .....	248
Configuration .....	249
Input Settings.....	249
Output Scaling .....	251
Zero Settings .....	252
Zero Settings Advanced.....	253
Enclosure & Mounting .....	254
Suspended.....	254
Wall Mounted .....	254
Antennas.....	255
Specification .....	256
Radio Range.....	256
T24-PR1.....	257
Overview .....	257
Order Codes .....	257
T24-PR1 .....	257
Connections.....	257
Power.....	257
Configuration.....	258

Input Settings.....	259
Output Settings.....	261
Output Scaling.....	263
Output Design.....	264
Zero Settings.....	267
Zero Settings Advanced.....	268
Configuration Examples.....	269
Print Gross Sum of 2 Modules to Printer.....	269
Customer Ticket from Handheld Module.....	270
Printer Operation and Maintenance.....	271
Paper Roll Fitting and Replacement.....	271
Buttons and Indicators.....	271
Enclosure & Mounting.....	272
Antennas.....	272
Specification.....	273
T24-PR1.....	273
Printer.....	273
Radio Range.....	273
T24-RDC-1, T24-RDC-2, T24-RDC-5, T24-RDC-10, T24-RDC-200.....	274
Overview.....	274
Order Codes.....	275
T24-RDC-1, T24-RDC-2, T24-RDC-5, T24-RDC-10, T24-RDC-200.....	275
Connections.....	276
Power.....	276
LED Indicators.....	277
Digital Input.....	278
Alarm Output.....	278
Configuration.....	279
System Settings.....	279
General Tab.....	279
Status Tab.....	281
GPRS Tab.....	282
Email Tab.....	283
Clock Tab.....	284
Silent Mode Tab.....	285
Macros Tab.....	286
POST Tab.....	287
Serial Tab.....	288
Inputs.....	289
Data Collection.....	291
CSV File Format.....	291
Power Mode Tab.....	291
Schedules Tab.....	293
Formatting Tab.....	295
Destinations Tab.....	297
SMS Reports.....	299
SMS Configuration.....	301
Triggered Reports.....	302
Trigger Tab.....	302
Message Tab.....	305
Destination Tab.....	306
Tokens.....	307
Token List.....	307
Time Date Formatting.....	310
Destinations.....	311
Email.....	311

SMS Message.....	311
FTP.....	311
TCP Socket (NOT YET IMPLEMENTED).....	311
HTTP Post.....	311
Battery Life.....	313
Scenario 1.....	313
Scenario 2.....	314
SIM Card Considerations.....	315
SIM Requirement.....	315
Key Tariff Features:.....	315
Pay As You Go SIM.....	315
Contract SIM.....	315
M2M Dedicated SIM.....	315
Service Provider Settings for T24-RDC.....	316
Service Providers.....	317
Service Provider Connection Details.....	317
Simple Mail Transfer Protocol (SMTP) Servers.....	319
SMTP Server Options.....	320
Mobile Service Provider SMTP Servers.....	320
Other "Free" SMTP Servers.....	320
Your SMTP server.....	320
Web Based Relaying SMTP server.....	320
SMTP Server Providers.....	320
Enclosure & Mounting.....	321
Antennas.....	321
Specification.....	322
Radio Range.....	322
<b>Base Stations &amp; Repeater Modules.....</b>	<b>323</b>
T24-BSi, T24-BSu, T24-BSue.....	323
Overview.....	323
Order Codes.....	323
T24-BSu.....	323
T24-BSue.....	323
T24-BSi.....	323
Addressing.....	323
Connections.....	324
T24-BSu & T24-BSue.....	324
T24-BSi.....	324
SW1 Settings.....	324
Address.....	324
Serial/USB.....	325
Power.....	325
LED Indication.....	325
RS232.....	325
RS485.....	326
Serial Limitations.....	326
USB.....	326
Communications.....	327
Configuration.....	328
Home.....	328
Radio Settings.....	329
Advanced Settings.....	330
Enclosure & Mounting.....	331
T24-BSi.....	331
T24-BSue.....	331
T24-BSu.....	331

Antennas.....	331
T24-BSi, T24-BSu, T24-BSue.....	331
Radio Range.....	331
Specification.....	332
T24-BSi.....	332
T24-BSu.....	332
T24-BSue.....	332
Radio Range.....	332
T24-AR.....	333
Overview.....	333
Order Codes.....	333
T24-AR.....	333
Connections.....	334
Power.....	334
Power Options.....	334
Permanently Powered.....	334
Battery Powered.....	334
Getting Started.....	335
Increase Range.....	335
Span Obstacles.....	335
Combined Solutions.....	336
Considerations.....	337
Configuration.....	338
Settings.....	338
Enclosure & Mounting.....	339
Antennas.....	339
Specification.....	340
<b>Power Supply Modules.....</b>	<b>341</b>
T24-BC1.....	341
Overview.....	341
Physical Connections.....	341
Specification.....	341
Example Batteries.....	342
VARTA LIP653450.....	342
VARTA LIC18650.....	342
UBC 581730.....	342
PP1 & SP1.....	343
Overview.....	343
Order Codes.....	343
PP1.....	343
SP1.....	343
Getting Started.....	344
Power Pack 1 Connections.....	344
Installation.....	344
Connecting Power Pack 1.....	344
Solar Panel Orientation.....	345
Operation.....	346
Dimensions & Weight.....	347
Specifications.....	348
<b>Appendices.....</b>	<b>349</b>
Appendix A - Enclosures.....	349
OEM Transmitter Modules.....	349
Dimensions.....	349
Opening the Case.....	349
Mounting Information.....	349
Antenna Position.....	350

Environmental Protection.....	350
ACM Type.....	351
Dimensions.....	351
Opening the Case.....	351
Mounting Information.....	351
Antenna Position.....	351
Environmental Protection.....	352
ACMi Type.....	353
Dimensions.....	353
Opening the Case.....	353
Mounting Information.....	353
Antenna Position.....	354
Environmental Protection.....	354
ACMm Type.....	355
Dimensions.....	355
Opening the Case.....	355
Mounting Information.....	355
Antenna Position.....	355
Environmental Protection.....	355
Handheld Type.....	356
Dimensions.....	356
Opening the Case.....	356
Mounting Information.....	357
Antenna Position.....	357
Environmental Protection.....	357
Appendix B - Antennas.....	358
Overview.....	358
Internal Chip Antenna (OEM Modules).....	359
Mounting.....	359
Specification.....	359
T24-ANTA.....	360
Mounting.....	360
Specification.....	360
T24-ANTB.....	361
Mounting.....	361
Specification.....	361
T24-ANTC.....	362
Mounting.....	362
Specification.....	362
T24-ANTD.....	363
Mounting.....	363
Specification.....	363
T24-ANTE.....	364
Mounting.....	364
Specification.....	364
Antenna Range.....	365
Appendix C - Radio Specification.....	366
Appendix D – Battery Selection.....	367
Considerations When Selecting Batteries.....	367
Re-chargeable or replacement.....	367
Required battery life.....	367
Size of.....	367
Operating temperature range.....	367
Self-discharge.....	367
Internal Resistance of battery.....	367
Connections to battery.....	367

Environmental .....	368
Optimising battery life.....	368
Battery Types.....	369
Appendix E – Approval Statements .....	370
CE.....	370
IC.....	371
FCC.....	372
Appendix F - OEM / Reseller Marking and Documentation Requirements .....	373
CE.....	373
IC.....	374
FCC.....	375
Appendix G - Worldwide Regional Approvals .....	376
Important Note .....	376
Appendix H - Declaration of Conformity .....	377
<b>EU DECLARATION OF CONFORMITY .....</b>	<b>377</b>
Appendix I - Warranty.....	378



---

## Introduction / Overview

The T24 Telemetry range of products provide remote measurement of a variety of inputs allowing the results to be relayed to a computer or PLC or to feed the data into other T24 modules that provide their own outputs such as analogue, ASCII serial or LED display for example.

The radios operate on the licence free 2.4GHz band and are approved for FCC, IC and European use.



The flexible transmission rates and low power usage allows for long battery life for remote modules.

Free Toolkit software provides simplified configuration of modules and other free software provides logging and visualisation functionality for Windows PCs.

---

## Navigating This Manual

When viewing this PDF manual the following tips will help you navigate.

Viewing bookmarks ( or ) to the left of the page, in the PDF viewer, will allow easy navigation to the relevant chapters of this manual. Alt-left arrow is a useful shortcut back to the last page viewed after a hyperlink is clicked. Hyperlinks are coloured green and are underlined.

---

## Product Quick Locator

This section allows you to locate your product quickly to navigate to the correct section of the manual.

### Strain Input

[T24-ACM-SA](#)    [T24-ACMi-SA](#)    [T24-ACMm-SA](#)    [T24-SAe](#)    [T24-SAi](#)

### Strain Input Fast

[T24-ACM-SAf](#)    [T24-ACMi-SAf](#)    [T24-ACMm-SAf](#)    [T24-SAfE](#)    [T24-SAfI](#)

### Voltage Input

[T24-ACM-VA](#)    [T24-ACMi-VA](#)    [T24-ACMm-VA](#)    [T24-VAe](#)    [T24-VAi](#)

### Current Input

[T24-ACM-IA](#)    [T24-ACMi-IA](#)    [T24-ACMm-IA](#)    [T24-IAe](#)    [T24-IAi](#)

### Temperature Input

[T24-ACM-TA](#)    [T24-ACMi-TA](#)    [T24-ACMm-TA](#)    [T24-TAe](#)    [T24-TAi](#)

### Resistance Potentiometer Input

[T24-ACM-RA](#)    [T24-ACMi-RA](#)    [T24-ACMm-RA](#)    [T24-RAe](#)    [T24-RAi](#)

### Pulse Input

[T24-ACM-PA](#)    [T24-ACMi-PA](#)    [T24-ACMm-PA](#)    [T24-PAe](#)    [T24-PAi](#)

### Wind Speed

[T24-WSS](#)

### Base Stations

[T24-BSi](#)    [T24-BSu](#)    [T24-BSue](#)

### Repeaters

[T24-AR](#)

### Receivers

[T24-HS](#)    [T24-HA](#)    [T24-HR](#)    [T24-AO1](#)    [T24-AO1i](#)    [T24-RM1](#)

[T24-SO](#)    [T24-GW1](#)

[T24-LD1](#)

[T24-PR1](#)

[T24-RDC](#)

### Power Supplies

[T24-BC1](#)    [PP1](#)

[SP1](#)

### Antennas

[T24-ANTA](#)    [T24-ANTB](#)    [T24-ANTC](#)    [T24-ANTD](#)    [T24-ANTE](#)

---

## T24 Telemetry Basic Principles

There are some basic radio settings and concepts that should be understood to effectively configure, deploy, optimise and troubleshoot T24 telemetry systems.

---

### Transmitters & Receivers

Although all of the T24 modules are in fact transceivers and transmit as well as receive, they tend to mainly operate as either a transmitter or receiver so we will choose to describe them as **Transmitters** and **Receivers**. The T24 system was designed so that Transmitters are configured to send out messages at a user defined rate. Receivers can then use this data to analyse, display or perform other actions depending on their function. A PC and base station are only required to configure the modules although they may be part of a data collection system. Once configured the T24 modules operate autonomously and only minimal control over the Transmitter modules is usually required, by Receiver modules, such as sleeping or waking.

---

#### Transmitters

These are the sensor modules that measure strain, voltage, temperature etc. and send messages containing the sensor value and status information at regular intervals for use by Receiver modules or for delivering to a PC via a base station.

Because these modules need to be very power efficient to operate on batteries they operate in three distinct modes. See [Transmitter Module Modes of Operation](#) later.

---

#### Receivers

These modules use messages provided by Transmitters and have functionality such as handheld displays, large displays, analogue outputs and relay modules. These modules may also offer control over Transmitter modules such as sleeping or waking.

---

## Radio Channel and Group Key

To be able to communicate, two radio modules must share some basic settings. There are ways to learn these and to recover unknown settings and these are discussed later in the **pairing** section.

---

#### Radio Channel

This is the frequency that the radio operates on. T24 radio bandwidth is divided into 15 channels. Modules must be on the same channel to be able to transfer messages.

---

#### Group Key

Group keys are a way of isolating groups of modules even if they are operating on the same radio channel. This can improve efficiency and also offer security because no radio module can affect another or see their messages unless they share the same group key.

A group key is defined by the user and is up to 15 alphanumeric characters.

Group keys were introduced in v3.0 radio firmware in March 2015. New radio modules will work with older radio modules but group keys cannot be used.

---

---

## Configuring Multiple Modules to Use the Same Radio Settings

Please note that when you pair to a remote module the base station adopts the radio channel and group key of the remote module.

To set the group key for a set of remote modules you can either:

Pair to each one in turn and set their radio channel and group key

or

Configure the base station by holding the shift key and clicking the **Pair** button on the [Home](#) page. Then configure the base station to the required [radio settings](#) then use the tool on the [radio settings advanced](#) page to pair to each module in the set to configure their radio settings to match the base station.

---

## ID and Data Tags

To configure a module its **ID** is used in communications. This is a unique 6 character identifier, such as **FF1234**, which is allocated at the factory. This ID is hexadecimal so can consist of numbers 0-9 and letters A-F.

If a module is a Transmitter it sends messages without broadcasting its ID. It identifies messages by using a Data Tag. This tag is a 4 character hexadecimal number and can be configured by the user. When modules leave the factory this data tag is set to the last 4 characters of its ID.

When Receiver modules or software want to use messages sent by Transmitter modules they identify the message they want by this Data Tag.

The reason Transmitter module messages are identified by a Data Tag rather than the unique ID is that this allows replacement of a Transmitter module without having to reconfigure the many Receiver modules that may be using its messages. It is only necessary to configure the replacement Transmitter module with the same data tag, radio channel and group key and the rest of the system will not notice the difference.

---

## Transmitter Module Modes of Operation

---

### Normal

Normal mode involves taking a reading and sending a message then entering into a very low power state before taking the next reading to maximise battery life.

Because it is not possible to communicate with the Transmitter module during this low power state a 'configuration' mode is required.

---

### Configuration

Configuration mode forces the modules to pause in sending their messages and to disable their low power state to enable configuration to take place. This is easily achieved by '**Pairing**' when using the T24 Toolkit software. Once configuration is complete the modules will resume their '**normal**' mode operation.

---

### Sleep

The last mode is sleep. Modules can be sent to sleep by other modules or they can go to sleep themselves when their messages are no longer being used. See [Sleep Delay Settings](#) later.

When sleeping, the modules can be awakened on demand by other modules or software via the base station.

---

## Transmitter Module Sleep Delay Settings

Transmitter modules have a **Sleep Delay** setting (set in seconds) which allows the modules to go into Sleep mode when their data messages are no longer required. This allows much longer battery life to be achieved.

Setting Sleep Delay to zero disables this function in the Transmitter modules and they will only go into Sleep mode when told to do so.

Most Receiver modules and T24 software send **Stay Awake** messages when they see messages arrive from Transmitter modules. In the Transmitter modules, if the Sleep Delay time period has elapsed without a Stay Awake message arriving then the module will enter Sleep mode.

Usually the Stay Awake messages are sent every 5 seconds so Sleep Delays should be set to at least 10 seconds but can be set to anything up to an hour for situations where the Receiver is likely to be out of range for periods of time but where the Transmitter module is required to stay awake and in normal operational mode during that time. It is usual that Sleep Delays are set somewhere between 30 and 300 seconds when required.

---

## Pairing

Because you need to know the radio settings configured in a module to be able to configure it, and there are no visible clues to what those settings may be, there is a feature used by T24 modules that enable the radio settings (i.e. the radio channel and the group key) to be determined and matched between two T24 modules.

Pairing is only required to determine and match radio settings and optionally to put T24 Transmitter modules in **configuration mode**. Because in some installations the T24 modules can be buried deep inside other equipment there had to be a way of indicating that a module has been selected to pair with without having physical access to that module. Pairing was therefore designed to be activated by removing and re-applying the module's power. In some cases this is not practical so another possible solution is **Soft Pairing** see later.

---

### Pairing From T24 Toolkit

When using the T24 Toolkit and a base station, pairing is used to connect to a module without having to know anything about it beforehand. To pair, remove power from the required module, click a 'Pair' button in the software and re-apply power to the module. The base station and module negotiate settings and the **base station is automatically configured to match the radio settings from the module** and places the module into configuration mode. Now the module can be configured and when complete it will return to normal operational mode.

---

### Pairing From a Receiver Module

Some Receiver modules allow pairing to a Transmitter module without requiring the T24 Toolkit. For example some handheld readers offer this feature by turning them on while holding a certain key after which the power is applied to the Transmitter module. The radio settings are then negotiated and the **Transmitter module is automatically configured to match the handheld radio settings**. The handheld learns the ID and data tags required to be able to use messages from the Transmitter module. In this case no configuration mode is required so the Transmitter module simply continues to operate in normal mode but with altered radio settings.

---

## Soft Pairing

Pairing by power cycling is absolute and will work under all circumstances. However, sometimes access to the power supply of a module that you want to pair to can be restricted, a module 20 meters up a tower for example, so the T24 Toolkit offers a way to *soft pair*.

**To achieve this you need to know the radio channel and group key of the remote module and configure the base station to match this. You must also know the unique ID of the module** and armed with this you can soft pair to the module. This works well with Receiver modules as they are not operating in low power modes but the software does need to try and change Transmitter modules from their normal operation mode into configuration mode therefore modules with transmission intervals greater than 5 seconds may be difficult to soft pair to.

This may not **always** work reliably in high traffic or high noise environments because there are a lot of messages that need to be sent between the base station and the remote module which can be upset by the presence of too many other messages on the same radio channel. If a connection cannot be made then power cycle pairing may be the only option.

---

## Configuring an Attached Base Station

Because a base station is attached to your computer when you are using the T24 Toolkit you do not pair to it the same way as with other T24 modules. To configure the base station using the Toolkit hold the shift key and click the **Pair** button on the [Home](#) page.

---

## Asynchronous Operation and Logging

Transmitters send their messages at a fixed user defined interval regardless of whether anything is listening. This **message interval** is timed from when the Transmitter has been woken or powered on so there is no synchronisation of when the actual measurement is taken between different transmitters.

If you are logging information from multiple Transmitters using multiple channel logging software you should be aware of how the software will store and record values.

The software stores the message values as they arrive from each Transmitter and when a log is to be recorded it is the last value received by each Transmitter that is used.

This means that the values that are recorded could have been measured at any point during the Transmitter message interval.

For example, if there are 10 Transmitters operating at 333ms message interval then when the values are recorded to the log file you can **only** be sure that those values had been recorded within 333ms of each other.

So if there is a requirement that recorded sets of readings are within a certain time of each other, then that time is the maximum message interval that should be set for the Transmitters regardless of the actual log interval of the software (Which should always be greater than the Transmitter message interval).

---

## Bandwidth

Each radio channel (1-15) has a finite ability to carry information. When modules do not need to communicate with each other they can be configured on separate radio channels and do not affect each other.

However, when multiple modules are on the same radio channel, even if they use different group keys, they are all contributing to filling the available bandwidth.

Each message transmitted takes up around 3 milliseconds so if everything worked perfectly and all modules transmitted at just the right time and with no gaps between then there could only ever be 300 messages per second being transmitted on any one radio channel.

In reality there are factors that reduce this capacity.

Each module uses a technique to detect whether anyone else is transmitting before it transmits itself and this takes a finite time. There can also be interference from other sources that can delay module transmissions.

Because of the transmission rate flexibility of the T24 modules there could be a few modules transmitting messages at fast rates or many modules transmitting messages at slow rates or any combination of these.

Practically there is a limit of around 200 messages per second available per radio channel.

It should be noted that as the number of Transmitter modules increases there is more chance of message collisions and so more messages are lost (remember that the Transmitter modules are sending their messages out at regular intervals) thus reducing the average number of messages per second arriving per module.

So, for example, 2 modules may transmit at 100 times per second or 100 modules at a rate of 1 per second.

---

## Repeaters and Repeater Subgroups

Repeaters are able to retransmit messages so that the repeated signal is stronger than the original and so can increase the range of systems or can bypass obstacles.

The repeater must be configured to operate on the same radio channel and use the same group keys as those modules it is repeating.

Because the radio traffic is effectively doubled by a repeater there is a mechanism to reduce unnecessary repetition of messages.

Sometimes a repeater will still see messages from modules that do not need to be repeated (Thus filling up available **bandwidth**) so both repeaters and all other T24 modules have a setting called the repeater subgroup.

By default all subgroup settings are set to zero. A repeater will repeat a message from all modules whose subgroup is either zero or matches its own subgroup. If a repeater subgroup is zero it will repeat messages from all modules.

This is a simple way to break down modules into smaller groups and control what messages get repeated.

Changing the repeater subgroup is not normally necessary unless the bandwidth is very full due to either many Transmitter modules being present or very fast transmissions from modules.

---

## T24 Toolkit

To configure the modules you must use the **T24 Toolkit** software application. This can be downloaded from our web site or may be shipped with your products.

The software is suitable for all versions of Windows.

Run setup.exe and follow the prompts to install the software.

In the Toolkit all items that can be changed or interacted with by the user are coloured green.

To change a value just click on the relevant green item. You will then be presented with a new dialog window allowing you to change the value.

This may use a slider, text box or list to allow your new value to be entered.

A base station will also be required to configure the T24 modules. If you have a USB version of the base station (T24-BSu or T24-BSue) then you just need to plug this into a USB socket on your PC. If you are using an alternative base station then please refer to the appropriate section of this manual.

## Common Toolkit Pages

These pages in the T24 Toolkit are applicable to all connected modules.

### Setup Base Station Communications

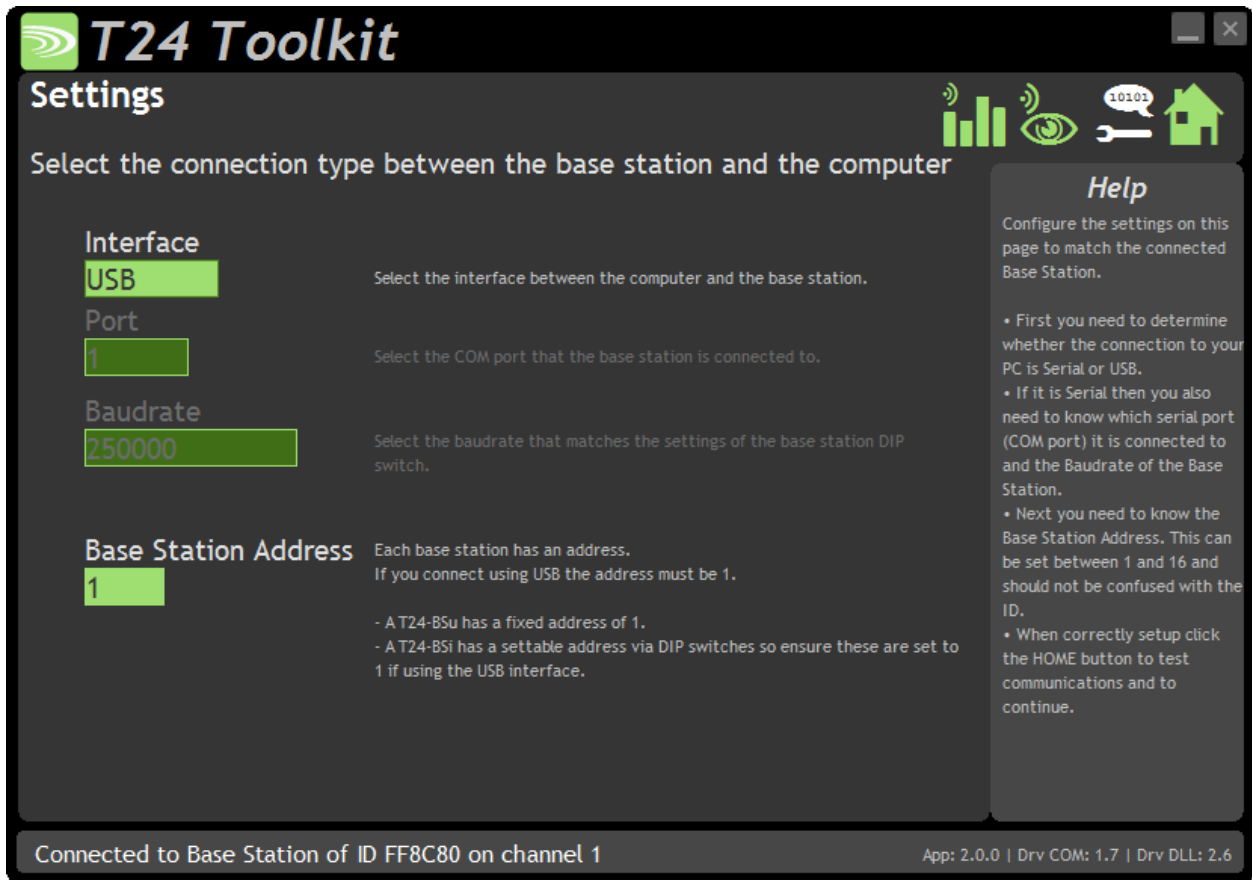

Select the appropriate interface type for the connected base station. If the base station is connected via a serial port then you will need to know the COM port it is connected to and the baud rate.

**The Base Station Address is usually 1.** This will only ever be different if it has been changed on base stations to support multi base station configurations.

Click the Home button to attempt communications with the base station.

If no communications can be established the toolkit will remain on this page. You will need to check that the base station is powered and that it is connected to any converters correctly.



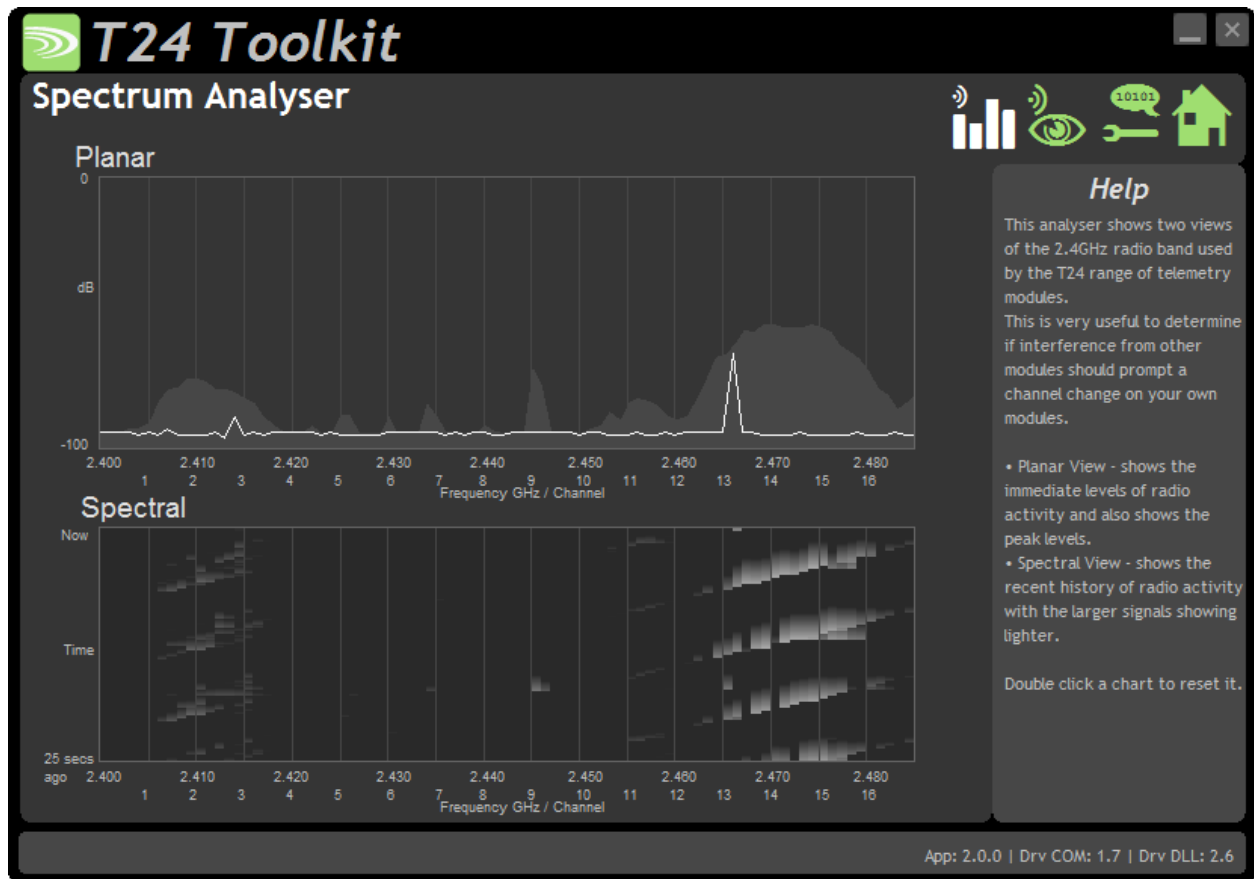

The analyser page is provided as a tool and will not normally be needed unless you plan to change channels and want to find the best channel to select, or to diagnose poor communications issues.

This page shows the radio signal levels detected across all the channels available to the T24 series of modules. Using this tool may help in detecting noisy areas and allow you to decide on which channels you may want to use.

The above charts show the traffic from a Wi-Fi network and it can be seen to be operating over channels 12 to 16 and it would be best (though not essential) to avoid using these channels.

Although 16 channels are shown the T24 modules operate over radio channels 1 to 15.

# Channel Monitor

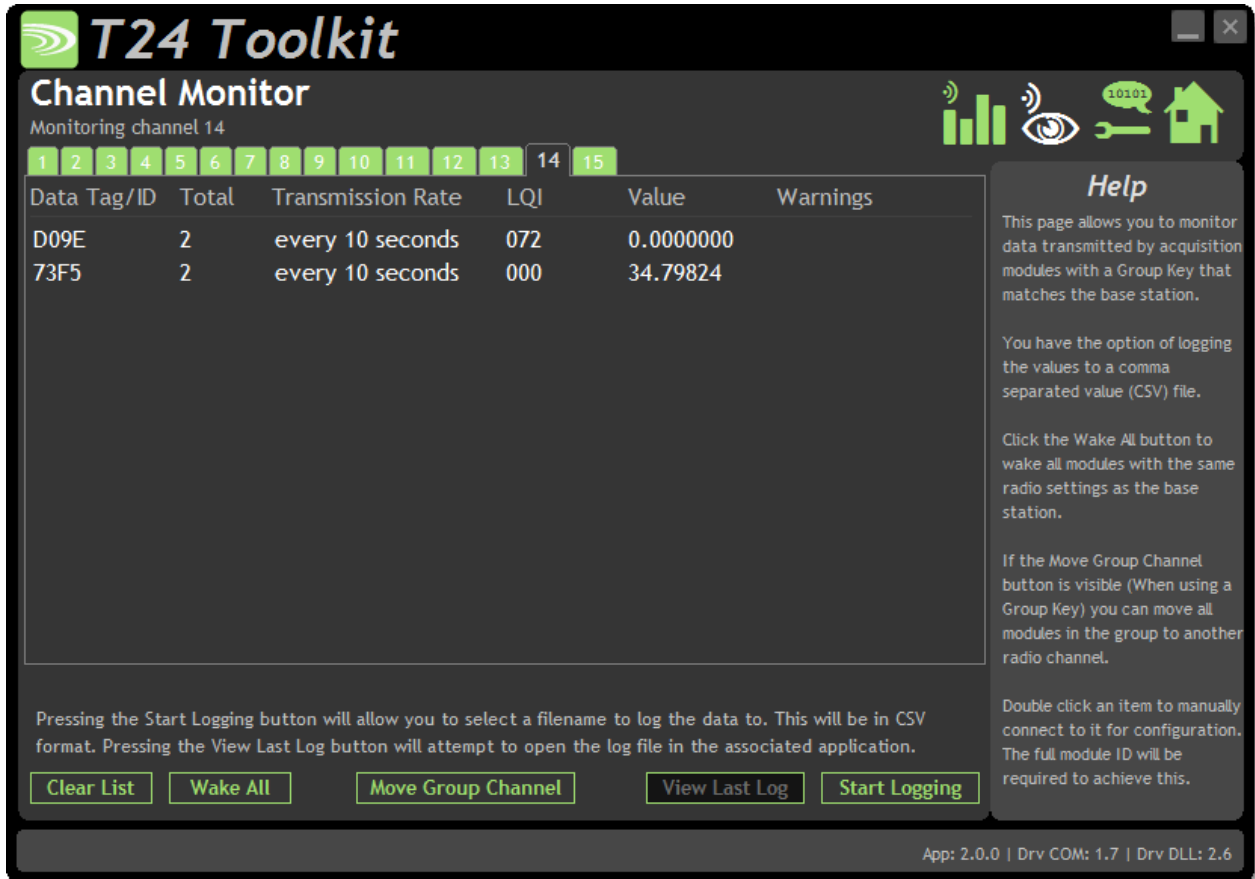

This page shows a summary of data sent by transmitter modules. You can see the Data Tag of transmitted messages along with the total number of messages received, the transmission rate, link quality, data value and any error messages. Some base stations can also list modules that are sleeping. These will show an ID instead of a Data Tag.

**i** To see any data the base station must be on the **same** radio channel as the transmitters and must have a **matching** Group Key

The radio channel of the base station can be changed by clicking the channel tabs along the top of the page.

If you want to change the Group Key of the attached base station you need to configure its radio settings. See [Configure Base Station](#)

### Items you can change or interact with:

- Radio Channel Tabs                      Click a tab to change the radio channel the base station is operating on
- Clear List                                      Clear all detected messages from the list
- Wake All                                        Wake all modules on the current radio channel

Start Logging	Asks for a filename then logs the received data to a CSV file in the following format:
	<b>Data Tag, Elapsed ms, Value</b>
View Last Log	Will launch the application associated with CSV files and open the last logged file.
Move Group Channel	If the base station has a group key set then this button will be visible. Once at least one module is present in the list this button will become enabled. Clicking it will ask the user for a new radio channel then all detected transmitters, along with all other modules on the same channel and group key such as handhelds, will all be moved to the selected channel. Once this has been achieved the base station itself will move and the list will start to fill again with messages on the new radio channel.

**i** *You will only see a list of detected transmitters on this page so you will need to ensure that any other receiver modules in the group are available to be woken. When this button is clicked all modules on the same radio channel and group key will be woken before they are changed to the target radio channel.*

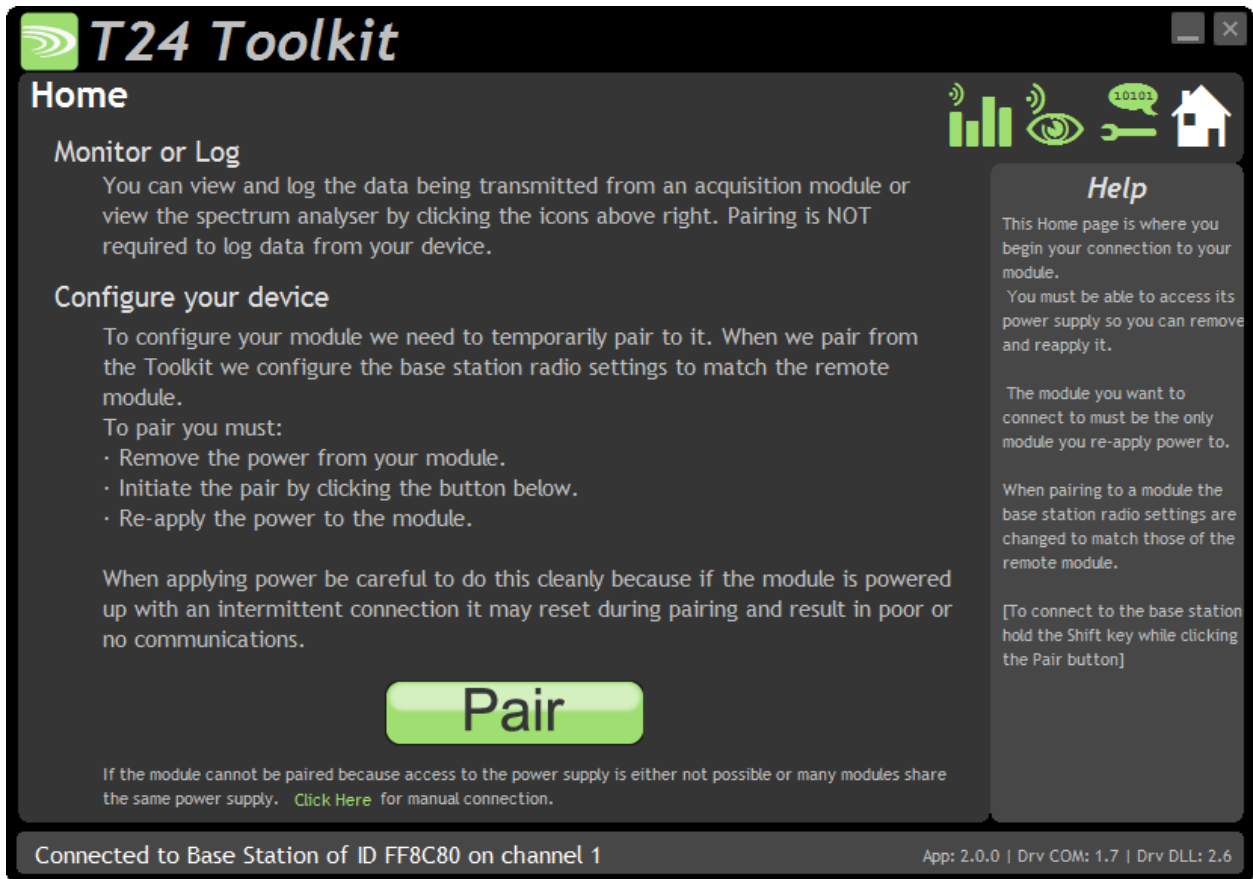

You now have successful communications with the base station so you can now pair with our remote T24 module or you can select the Spectrum Analyser mode or Data Provider Monitor mode.

## Connecting to a remote module

To connect to a remote module you will pair. This is achieved by power cycling the module. Pairing removes the need to know the radio settings of the module you are connecting to and also ensures that it is in a suitable state for configuration.

### Pairing Procedure

- Remove power from the T24 module.
- Click the Pair button on the Toolkit.
- You now have 10 seconds to re-apply power to the T24 module.

If you connect successfully the Toolkit will change to the Information page. If the pairing fails try again.

**i** Pairing with the toolkit will **not** change the radio configuration settings of the connected module. The base station radio settings will be changed to match those of the remote module.

**i** When the toolkit connects to a remote module to enable configuration it will usually inhibit the normal operational transmission of messages

---

## Connecting to the attached base station module

To connect to and configure the connected base station, hold the shift key and click the Pair button.

---

## Manual Connection

If you cannot get to the power supply of the remote module you can attempt to connect manually using [Soft Pairing](#). Click the 'Click Here' link at the bottom of the page and follow the prompts.

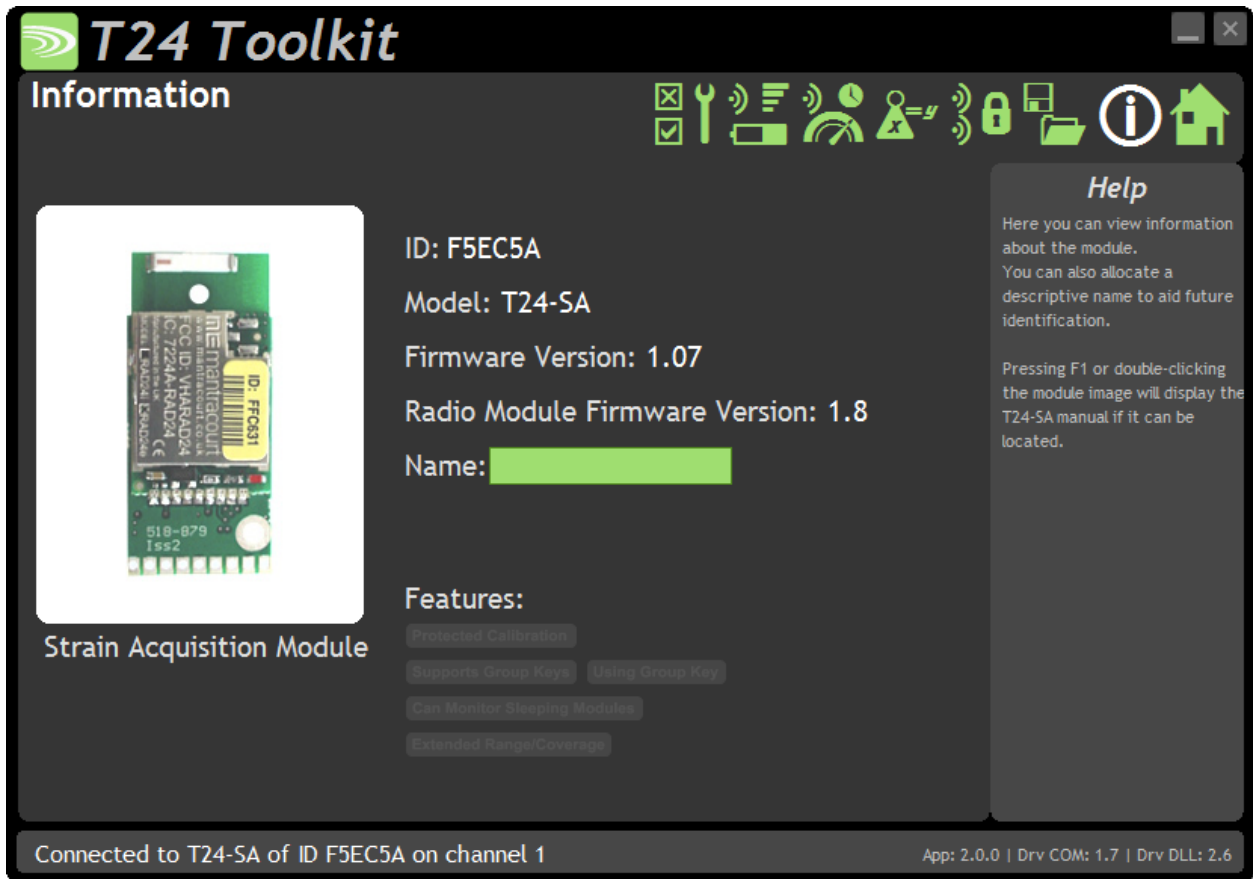

Once successfully paired to a module this page is displayed showing you information about the connected module.

**Items you can change:**

**Name** You can enter a short description which may help you recognise this module in the future.

**Features**

Each module may support certain features which are indicated on this page. If the feature is greyed out then it is not supported. If it is coloured then it is supported.

- Protected Calibration** Some transmitter modules may have had their calibration protected. This indicates that you cannot calibrate this module.
- Supports Group Keys** [Group Keys](#) were introduced in 2015 so modules built before this date will not support this feature. This indicates that the connected module can support them
- Using Group Key** This indicates that the connected module can support Group Keys and that one has been configured for this module
- Can Monitor Sleeping Modules** Applicable to a base station only. This indicates that on the [Channel Monitor](#) page modules that are sleeping will also be listed
- Extended Range/Coverage** Extended range radios were introduced to the T24 range in 2015. This indicates that the connected module has an extended range radio fitted.

## Battery and Radio Levels

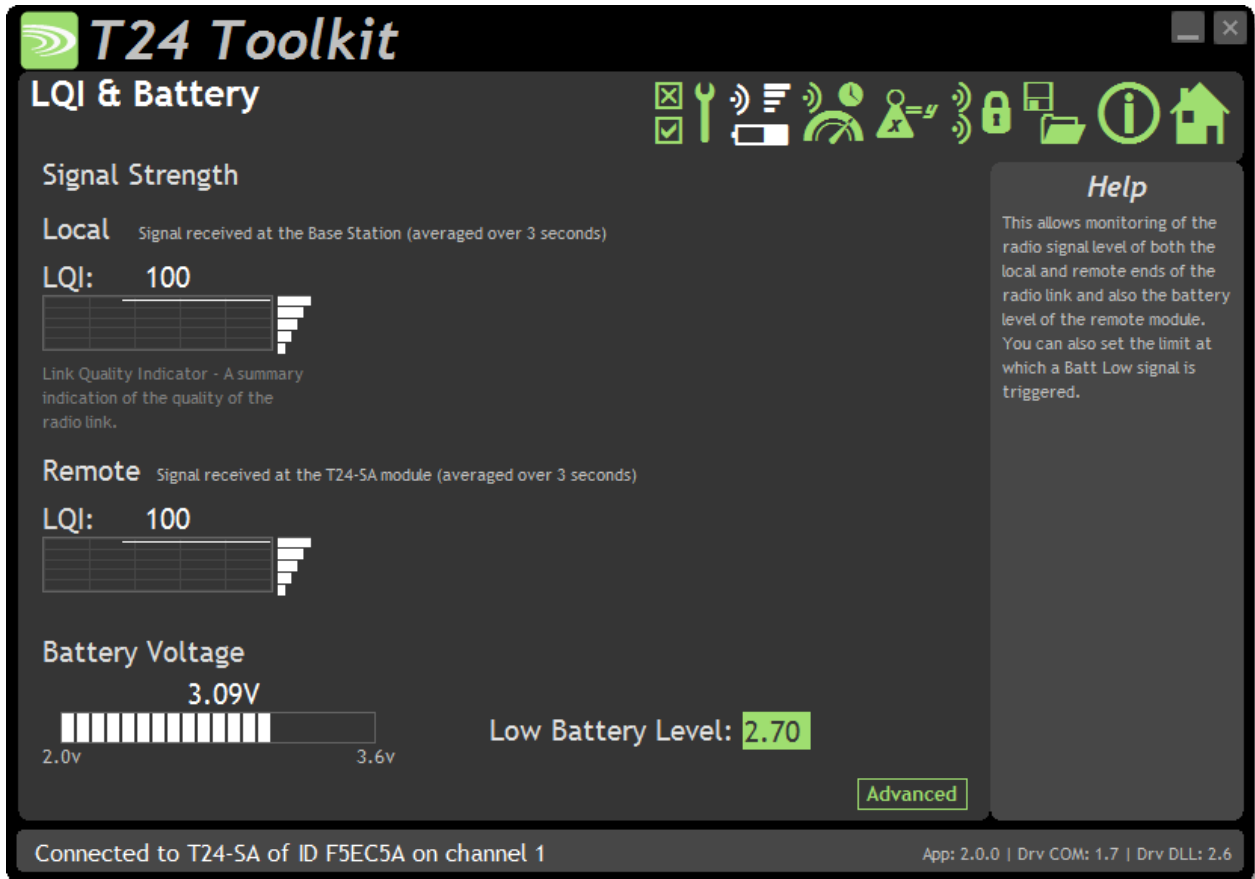

Here you can see the voltage of the battery and the radio signal levels at the base station and the remote transmitter module. This simple view gives an LQI value which stands for Link Quality Indicator. This value will range from 0 to 100 and within this band you should still achieve communications. As the level drops towards zero communications may become intermittent but still achievable.

On modules that are battery powered the battery voltage section will be visible. You can set the level at which the transmitter module reports a low battery. (At 2.1V the module will stop working) If the battery voltage is below the Low Battery Level the bar will be coloured orange.

### Items you can change:

Low Battery Level                      Click this item to set the battery low level.

Clicking the Advanced button will give more detailed information on the RSSI and CV levels of the received radio packets.

## Battery and Radio Levels Advanced

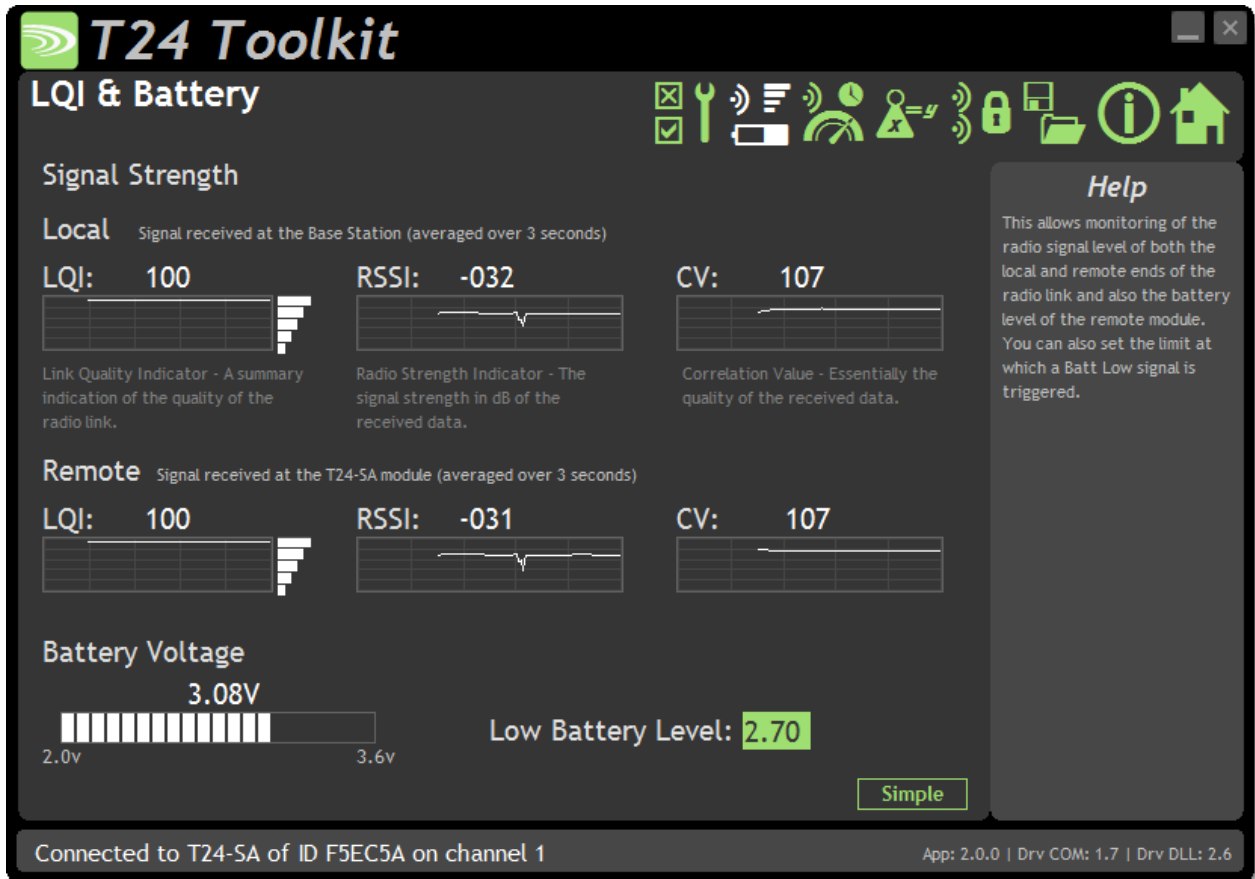

**LQI** value which stands for Link Quality Indicator. This value will range from 0 to 100 and within this band you should still achieve communications. As the level drops towards zero communications may become intermittent but still achievable.

**RSSI** is effectively the received dB level which will range from about -30 which is a good signal to -98 which is a weak signal.

**CV** is the correlation value and indicates how well the signal can be decoded. This ranges from 55 which is a poor quality signal and 110 which is an excellent signal.



# Radio Settings

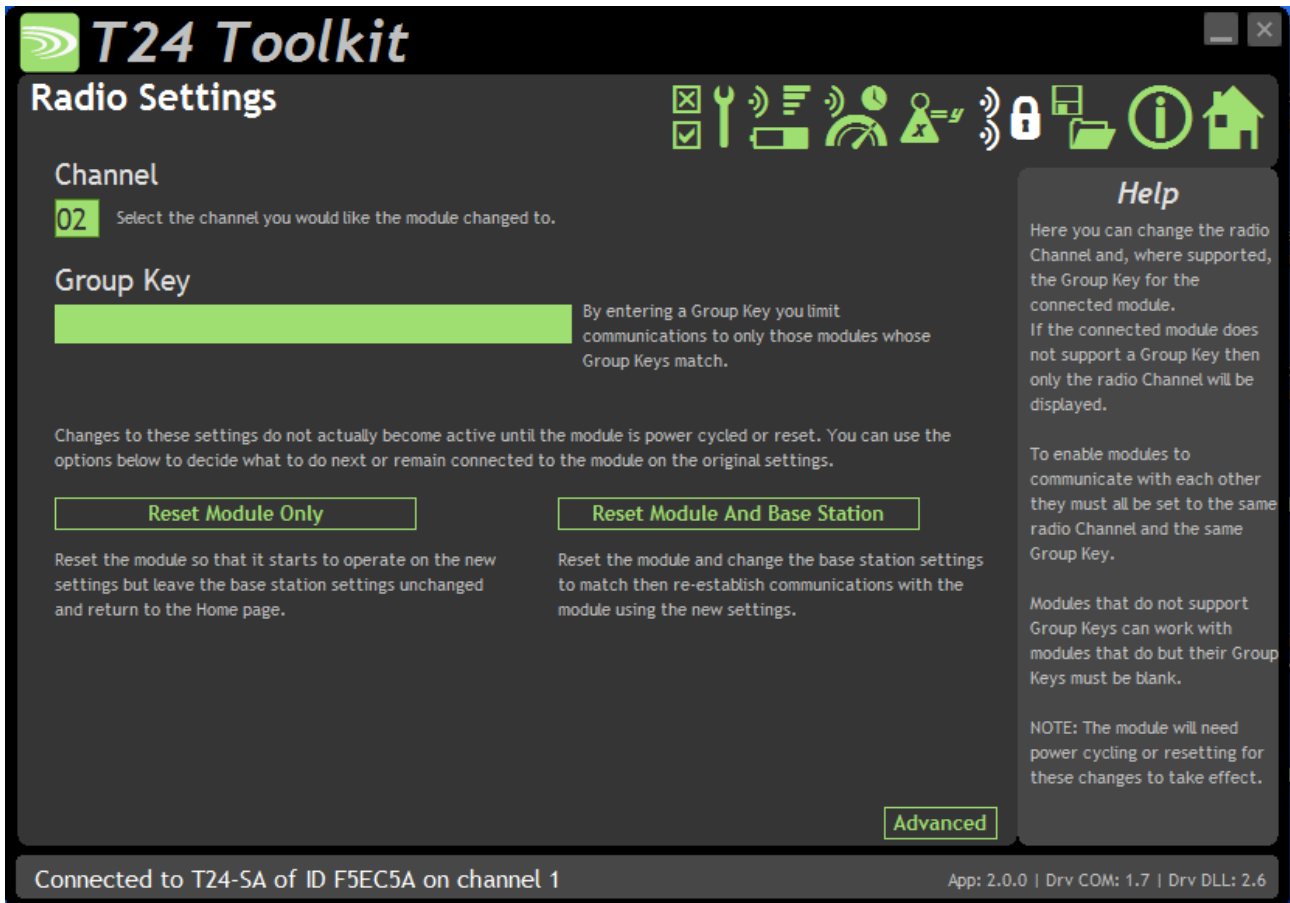

Here you can change the channel and group key for the connected module.

### Items you can change:

**Channel** Select a [radio channel](#) between 1 and 15. The default is channel 1. You can use the [Spectrum Analyser](#) mode to determine a good clean channel to use.

**Group Key** **Only visible on modules that support [Group Keys](#).** Only modules with identical group keys can communicate. You can isolate groups of modules on the same channel or just use the key to ensure the data cannot be read by somebody else. Early versions of T24 modules do not support Group Keys and this option will not be visible in the Toolkit.

**To use modules that support Group Keys with older modules that do not then the Group Keys must be blank.**

---

The following two options are not visible when changing radio settings for a base station. In that case changes are immediate.

**Reset Module Only** **Only enabled once a change has been made.** When radio settings are changed they do not take effect immediately but require a reset or power cycle. This button forces the connected module to adopt the new settings but keeps the base station on the existing settings. The home page is then shown.

**Reset Module and base Station** **Only enabled once a change has been made.** When radio settings are changed they do not take effect immediately but require a reset or power cycle. This button forces both the connected module and the base station to adopt the new changes and re-establishes a connection.

## Radio Settings Advanced

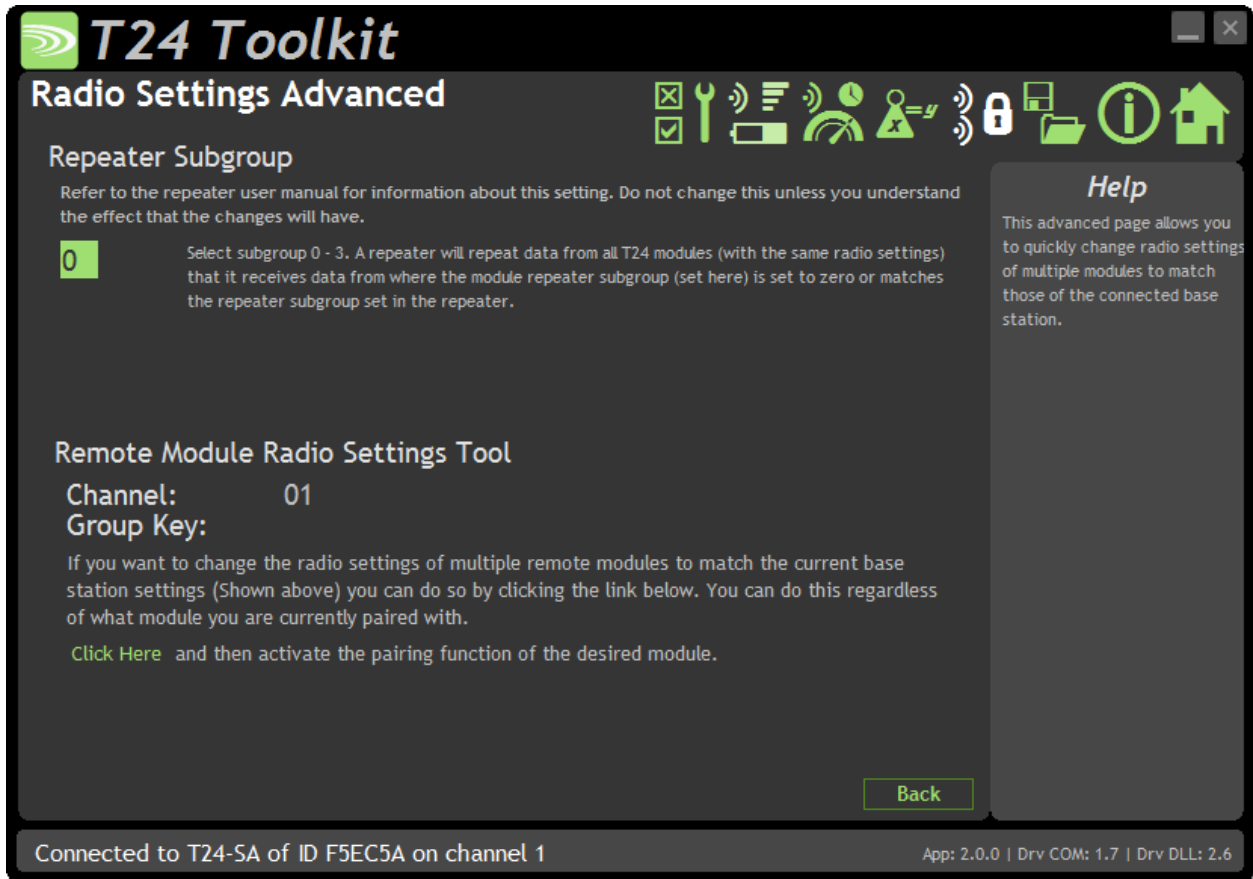

Here you can change the repeater subgroup settings for the connected module. Also a tool is provided to quickly match remote module radio settings to the base station radio settings.

### Items you can change:

Repeater Subgroup

Select a repeater subgroup for this module. The default is zero which will let all repeaters repeat messages from this module. See [Repeaters and repeater Subgroups](#)

Remote Module Radio Settings Tool

To quickly set a batch of remote modules to match the radio settings of the base station you can use this tool. Usually this is arrived at by pairing with the base station by holding the shift key whilst clicking the Pair button on the [Home](#) page.

To change the remote module radio settings:

- Remove remote module power
- Click the Click Here link on the page
- Apply power to the remote module

The Toolkit will remain unchanged and still paired to whatever module or base station it was paired to but the remote module will have changed its radio settings.

## Save and Restore

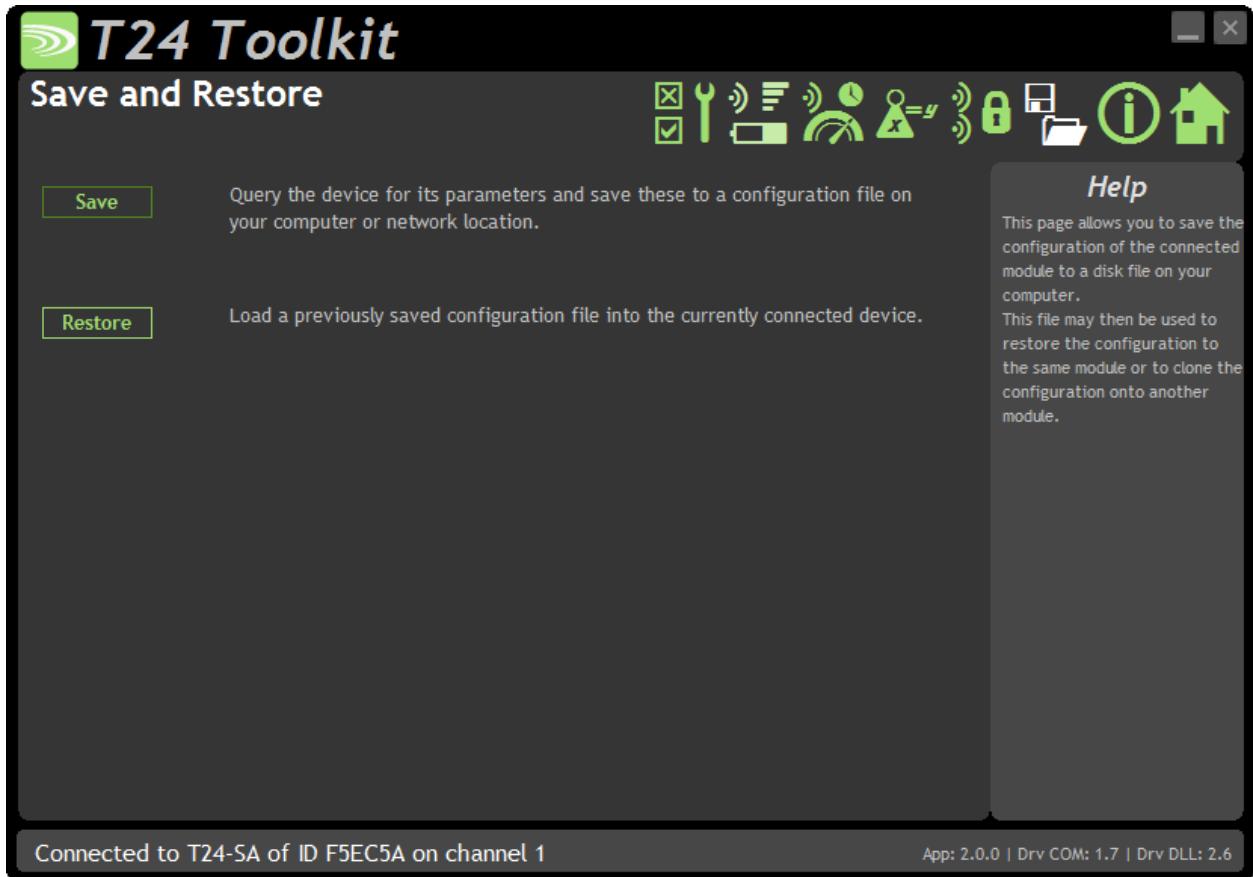

Here you can save the module settings to a file on your PC so that they can be later loaded back into the same or different module.

### Items you can change:

Save

Click this button to open a file dialog window to allow you to select a filename and location to save the configuration file to.  
All configuration information including calibration data will be saved to the file.  
The file extension is **tcf**.

Restore

Click this button to open a file dialog window to allow you to select a filename and location of a previously saved file to load into the connected module.  
All configuration information **including** user calibration data will be overwritten.  
The file extension is **tcf**.

---

# Transmitter Modules

T24 Transmitters are the modules that connect to a sensor or have an input signal applied and periodically transmit messages containing the value read from the sensor or input.

---

## T24-ACM-SA, T24-ACMi-SA, T24-ACMm-SA, T24-SAe, T24-SAi

---

### Overview

The range of SA modules provide measurement from strain gauges and load cells.

---

### Order Codes

---

#### T24-SAe



OEM strain transmitter module with external antenna UFL connector.

#### T24-SAi



OEM strain transmitter module with integral antenna.

---

#### T24-ACM-SA



Strain transmitter module mounted in large weatherproof enclosure with battery holder for two D cell alkaline batteries. Also has ability to be powered from external supply voltage.

#### T24-ACMi-SA



Strain transmitter module mounted in medium weatherproof enclosure with battery holder for two AA batteries.

---

#### T24-ACMm-SA



Strain transmitter module mounted in small enclosure with screw terminals to connect external 3V power supply.

---

---

## Connections

---

### T24-SAe, T24-SAi

---

#### Power

Attach power supply wiring to the module as shown below:

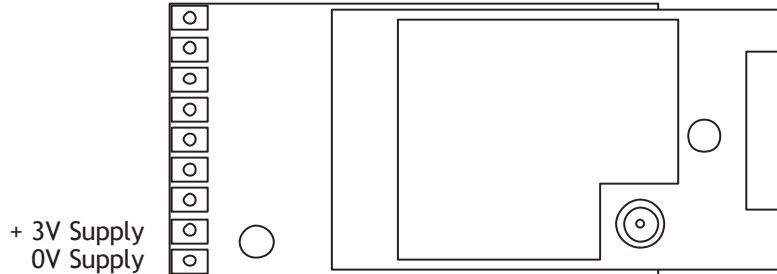

Connect to a 3 Volt power supply or batteries.



This module is **not** reverse polarity protected!  
The maximum voltage is 3.6 V!

For battery information please refer to [Appendix D – Battery Selection](#)

---

#### Sensor

Strain gauge connection is 4 wire as follows:

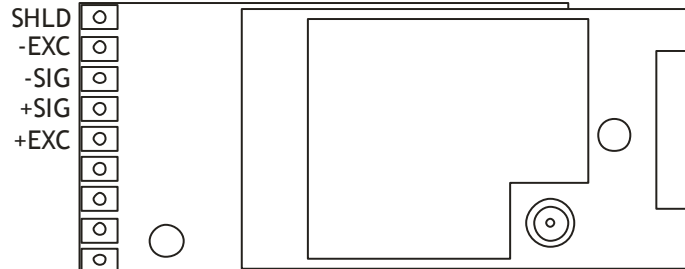

The resistance of the strain gauge can be between 85 and 5000 ohms. The T24-SA can support up to four 350 ohm strain gauges bridges attached in parallel (At the expense of reduced battery life).

The cable lengths between the T24-SA and the gauges should be kept below three meters and generally as short as possible.

As the measurement is four wire then as the cable length increases the voltage drops in the cable will have more of an effect on the factory mV/V calibration.

The strain gauge measurement is bi-directional, i.e. tension & compression.

Power

Power can be supplied by fitting two 'D' cell alkaline 1.5 V batteries or the module can be supplied from an external 5 Vdc to 18 Vdc source.

In both cases you need to fit the JP1 power jumper to supply power to the transmitter module. When powered from the external DC source the LED will illuminate.

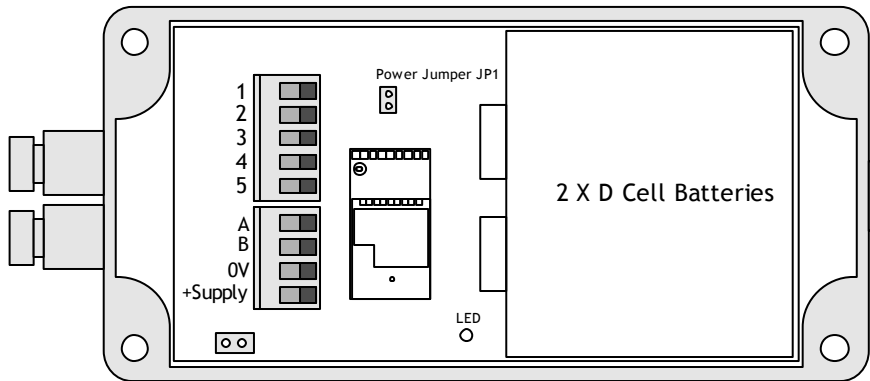

For battery information please refer to [Appendix D – Battery Selection](#)

Sensor

The strain gauge input is connected to the module via a 2 part screw terminal block.

Screw Terminal	Function
1	+5 V Excitation
2	+Signal
3	-Signal
4	-Excitation
5	Shield
A	Digital Output
B	

---

## T24-ACMi-SA

---

### Power

The enclosure is designed to accept two AA batteries. Maximum voltage 1.8 V per cell.  
For battery information please refer to [Appendix D – Battery Selection](#)

---

### Sensor

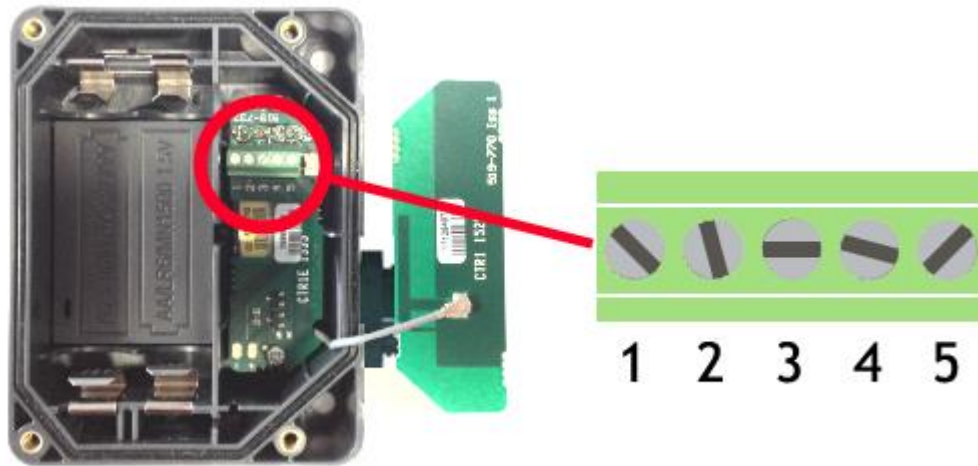

The input connections are accessed by lifting the right hand cover plate, this plate incorporates the T24-ACMi Antenna; take extra care when re-assembling that the grey UHF cable is attached to the antenna socket.

Screw Terminal	Function
1	Shield
2	- Excitation
3	-Signal
4	+Signal
5	+ 5 V Excitation

## T24-ACMm-SA

### Power

Power is supplied by connecting a 3 V supply to the terminals as shown below.

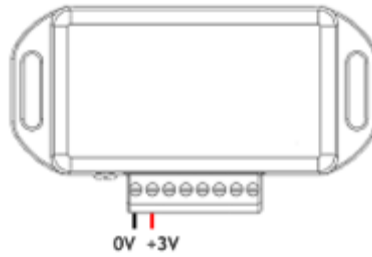

! There is no reverse polarity protection

### Connecting T24-BB1

Power to transmitter modules in this enclosure can also be supplied by a T24-BB1 battery box which contains two AA 1.5 V batteries.

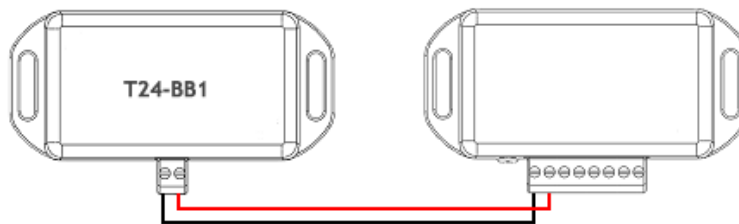

For battery information please refer to [Appendix D – Battery Selection](#)

### Sensor

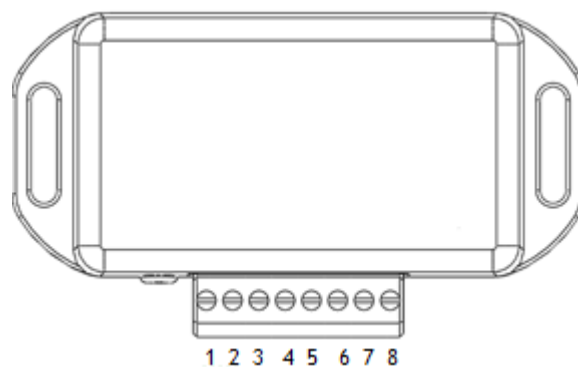

Screw Terminal	Function
5	-Excitation
6	-Signal
7	+Signal
8	+5 V Excitation



## Using Completion Resistors

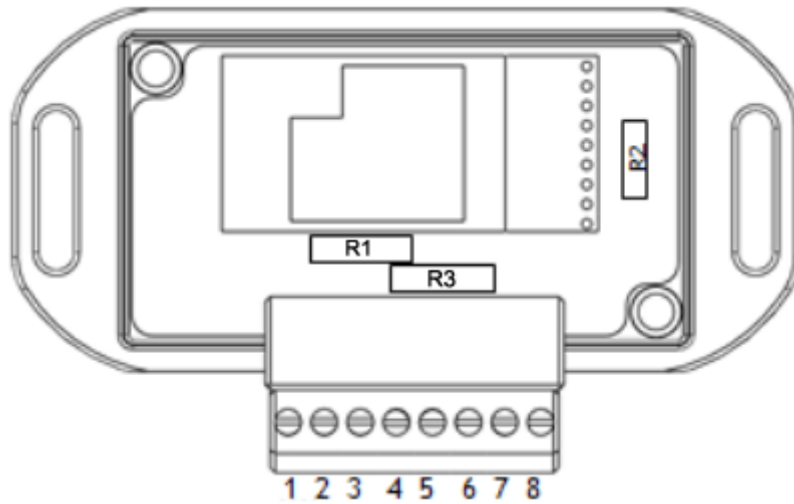

The T24-ACMm has the option for users to add up to three completion resistors, these can be used to enable the T24-ACMm to accept half and quarter bridge strain input when a strain transmitter module is fitted. The three completion resistors are located as shown below:

If using a half bridge only R1 and R2 need to be fitted, we recommend low drift precision resistors to ensure reading stability typically 0.1% 5ppm/°C. If using a quarter bridge R1, R2 and R3 must be fitted, R3 must be the same resistance as the single gauge being used in the quarter bridge. The diagram below shows how you should wire for full, half and quarter bridge configurations.

### Full Bridge

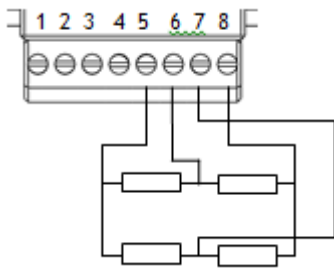

### Half Bridge

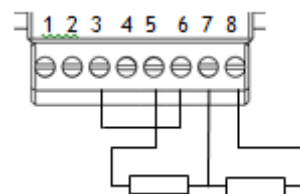

### Quarter Bridge

Strain Element in Compression

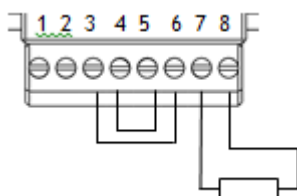

Strain Element in Tension

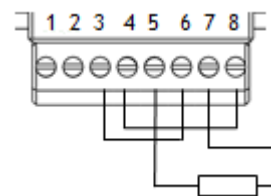

---

## Shield Connections (All Enclosures)

We recommend the following rules to determine whether there should be a connection between the transmitter module shield and the sensor chassis or cable:

1. If the sensor is remote to the transmitter module and the screen of the signal cable is **NOT** connected to the sensor chassis then the cable screen should be connected to the transmitter module shield connection.
2. If the sensor is remote to the transmitter module and the screen of the signal cable **IS** connected to the sensor chassis then the cable screen should be **NOT** connected to the transmitter module shield connection.
3. If the transmitter module is integral to the sensor or mounted very close and the module is mounted on a metal chassis then the answer to whether the transmitter module shield connection should be connected to the metal chassis is a matter of experimentation. This connection must be as short as possible. The T24 Toolkit can be used to chart the signal levels and tests should be undertaken to determine whether there is a better radio signal with or without the shield/chassis connection. The quality of the measured reading should also be looked at. In cases where the shield/chassis connection makes no difference to the radio signal or the reading quality then the connection should be made.

## Configuration

The T24 Toolkit provides a means of simple configuration and calibration of the transmitter module along with useful tools to aid integration.

Launch the T24 Toolkit software application and pair to this module to enable the connection to the Toolkit to allow configuration to take place. [See Common Toolkit Pages - Home](#)

## Data Rates and Quality

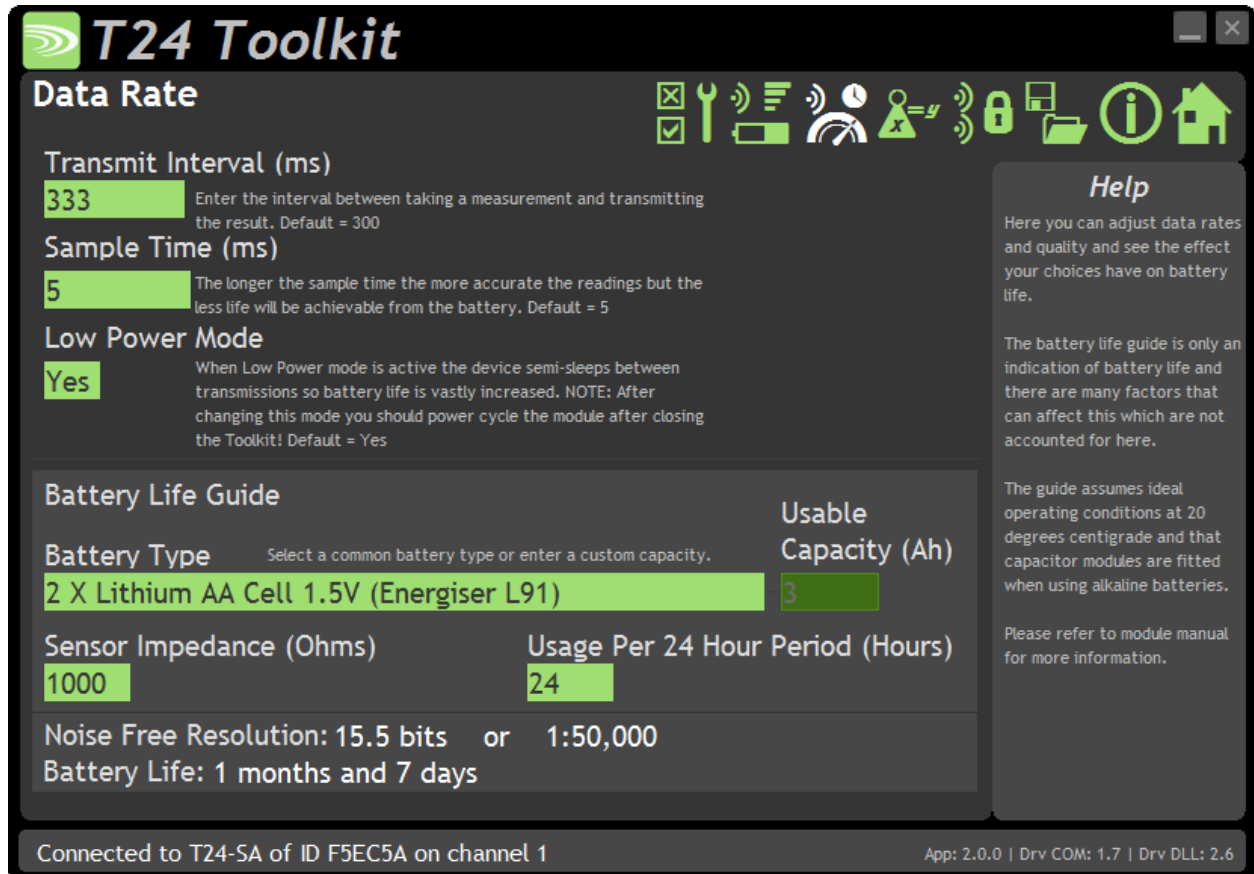

This page allows you to select the rate at which data is transmitted from the transmitter module and the quality. By selecting low power mode and entering some other information the toolkit will also give guides on achievable battery life.

Note that the battery life calculator is assuming the best case scenario which is at 20 °C and that the battery has a suitable low internal resistance or that a suitable capacitor is fitted across the battery. See battery details in the Installation section.

### Items you can change:

Transmit Interval

Enter the transmission rate in milliseconds. The default is 300 giving approximately 3 per second which is ideally suited to reading on a handheld. You may want to slow this down to achieve longer battery life.

Sample Time

This is the length of time in milliseconds that the input is sampled before the value is transmitted. This can vary between 5 milliseconds and close to the Transmit Interval. A shorter sample time means that the module is awake for less time so battery life is increased but at the expense of a reading with less noise free resolution. You can vary this to see the effect on battery life and noise free resolution.

Low Power Mode	<p>Unless the transmitter module is non battery powered this should be set to Yes. In between transmissions the transmitter module will enter sleep mode which, for some modules such as the strain gauge transmitter module, will have a massive effect on battery life.</p> <p>A reason for <b>not</b> using Low Power Mode would be if using the module in a Master-Slave arrangement with PC for example.</p>
Battery Type	<p>This is not a parameter of the module but information used by the battery life guide. You can choose from some preset batteries or choose custom to allow you to select your own battery capacity. See below. This will also offer to change the Battery Low Level if the level suitable for the chosen battery is not the level currently set.</p>
Usable Capacity	<p>This is not a parameter of the module but information used by the battery life guide. This is the capacity of the battery in Amp Hours and has a profound effect on battery life calculations. This capacity needs to be calculated from battery manufacturer's data sheets to take into account that you can only use batteries down to 2.1 volts so in the case of twin AA cells this would be 1.05 volts.</p> <p>Generally the usable capacity will not be as high as that advertised by the battery manufacturer. Temperature and internal resistance of the battery are not taken into account in the guide.</p>
Sensor Resistance	<p>This is only available for certain transmitter modules. This is not a parameter of the module but information used by the battery life guide. Enter the resistance of the connected strain gauge in Ohms.</p>
Usage Per 24 Hour Period	<p>Enter the number of hours per 24 hour period that the T24-HS handheld will be turned on and communicating with a transmitter module.</p>

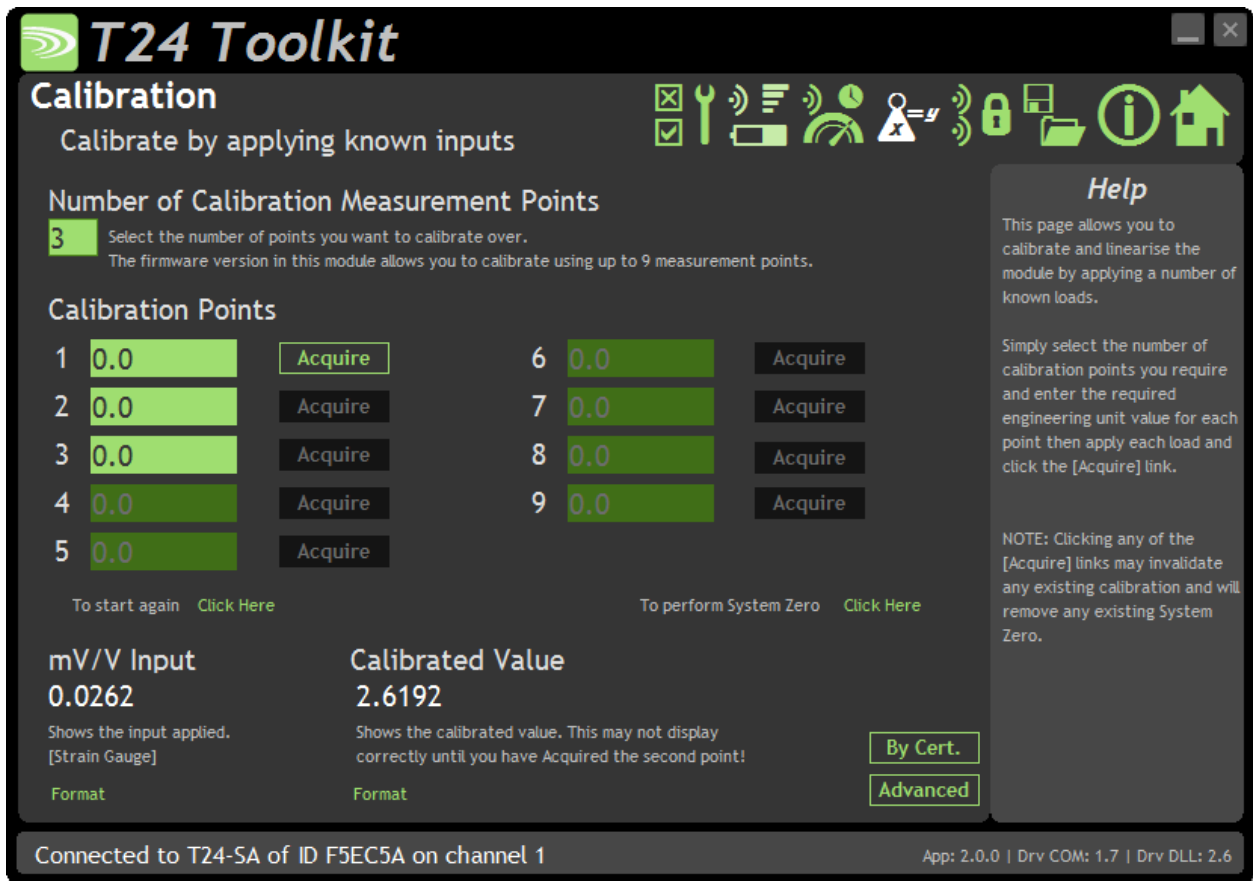

Here you can calibrate the transmitter module and set a system zero if required. This simple page allows semi-automated calibration where you can apply known inputs to calibrate. This calibration includes linearization and is automatically applied. See later for **By Cert** and **Advanced** page where you can adjust individual gains and offsets.

**Calibration Process**

- Decide on how many points you will calibrate over.
- Decide what weights will be applied (in ascending order) at each point.
- Enter the actual input (in the required units) that you want the module to read at each point.
- Now proceed to apply each input in turn (allowing a settle time) and click the **Acquire** button at that point. You can now apply the next input and click **Acquire** until all the points are completed.

**i** *The mV/V from the load cell must be ascending through each calibration point.*

The bottom of the page shows the **Input Value** and the **Calibrated Value**. Once the second point has been acquired this **Calibrated Value** should display the actual calibrated value.

**Items you can change:**

Number of Calibration Points    Enter the number of points you wish to calibrate over. In its simplest form you could select two for a linear calibration. For more complex calibrations which include linearization select three to nine points.

Point 1 - 9    For each point enter the engineering unit value that you want the transmitter module to report at the applied input. i.e. 1.67

Acquire 1 - 9	Click this button when the input has been applied and the reading has been allowed to settle. This will acquire the reading and allow you to move to the next points. You will be able to click the button again to re-acquire.
Start Again	Click here to restart the calibration.
System Zero	Once calibrated you may want to remove a fixed system value. In the case of a strain gauge input this may be the weight of a sling, shackle, load bed etc. Apply the required input and click here to set the system zero. The current input will be removed from subsequent readings so that the reading will be zero. To edit this value manually click the <b>Advanced</b> button. System Zero is stored in non-volatile memory in the transmitter module.
By Cert.	You can click the <b>By Cert</b> button to calibrate against a sensor calibration sheet. You just need to enter the input values and associated engineering unit required output value of at least 2 points. This will take you to a different screen.
Advanced	Clicking the advanced button will allow you to edit the gains and offsets for each available calibration point. This will take you to a different screen.

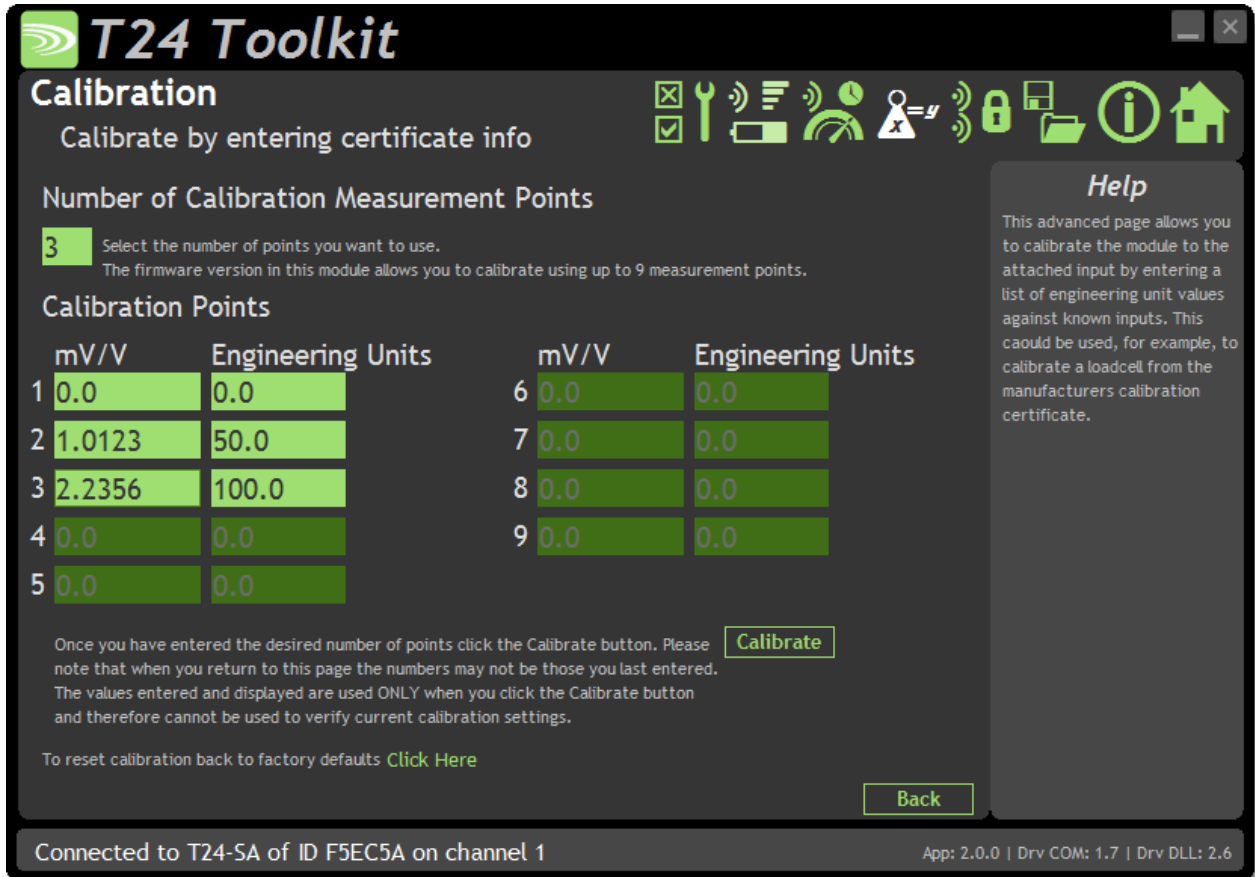

In some circumstances it may not be possible to apply inputs in which case the calibration can be entered manually from the calibration table or certificate for a load cell without ever having to connect the load cell.

**Items you can change:**

- Number of Calibration Points    Enter the number of points you wish to calibrate over. In its simplest form you could select two for a linear calibration. For more complex calibrations which include linearization select three to nine points.
- Input Points 1 – 9 (mV/V shown in this screenshot)    Enter the input point for which you will specify a required engineering output value
- Engineering Units 1 - 9    Enter the required engineering unit output for the specified input value
- Calibrate    Click this button to calculate and update the module calibration

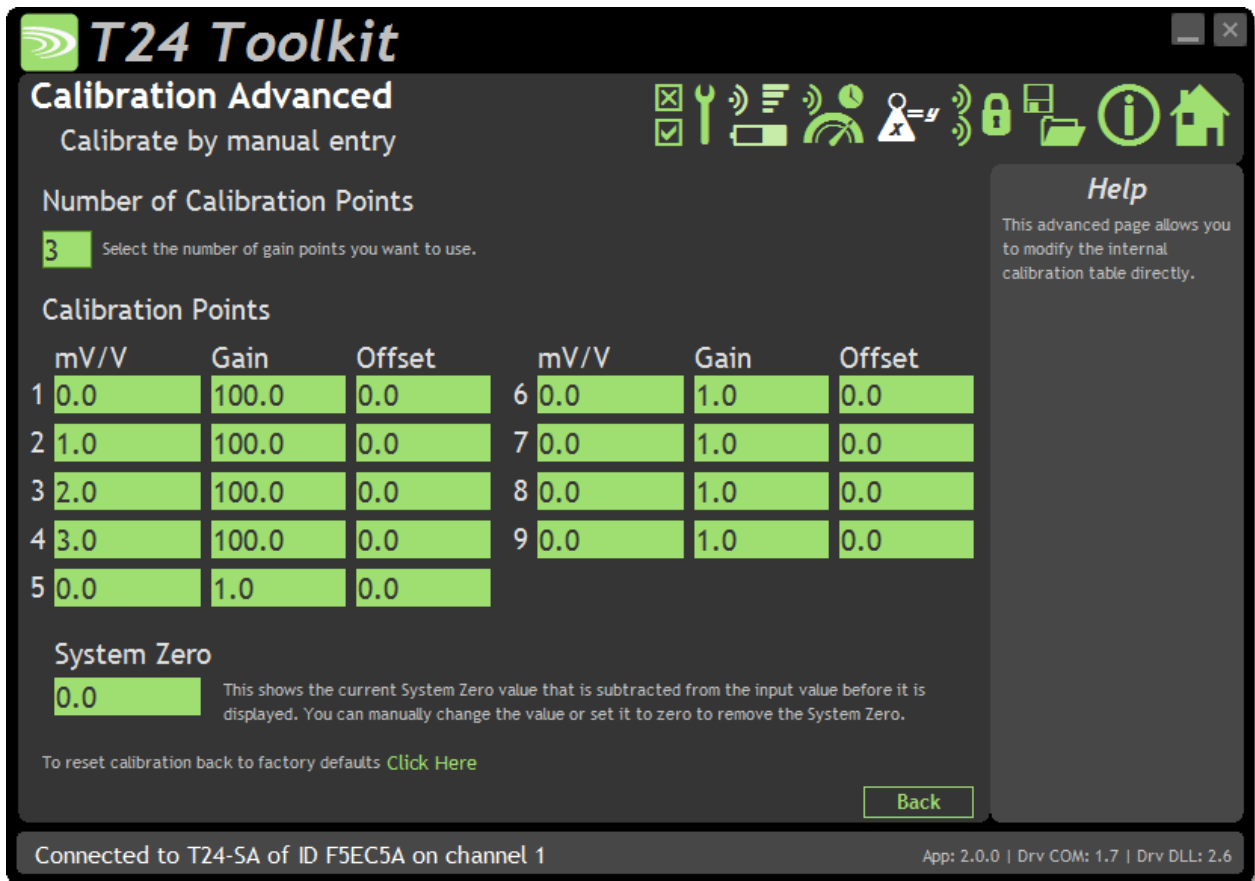

In some circumstances it may not be possible to apply inputs in which case the calibration can be entered manually.

For example, if a strain gauge manufacturer provides a calibration table for a cell it may be possible to calculate gains and offsets and enter these values into the Advanced Calibration page without having to connect the strain gauge or apply weights.

**Items you can change:**

**Number of Calibration Points** Enter the number of points you wish to calibrate over. In its simplest form you could select two for a linear calibration. For more complex calibrations which include linearization select three to nine points.

**Input Points 1 – 9 (mV/V shown in this screenshot)** Enter the input point to which the associated interpolated gain and offset values will be applied. Note between points the gain and offset values are linearly interpolated. Inputs are extrapolated below point 1 and above point 9.

**Gain 1 - 9** Enter the gain value for associated point

**Offset 1 - 9** Enter the Offset value for associated point

**System Zero** You can set the system zero value here or set it to zero to remove the system zero effect.

**Description of Linearisation Calculations**

The input value is looked up in a table of points starting from point 1. If the input mV/V is greater than the mV/V specified at that point then it is checked against the next point. When the best point has been found the Gain and Offset values from that point are applied to the mV/V value as follows.

$$\text{Value} = (\text{input} * \text{Gain}) - \text{Offset}.$$



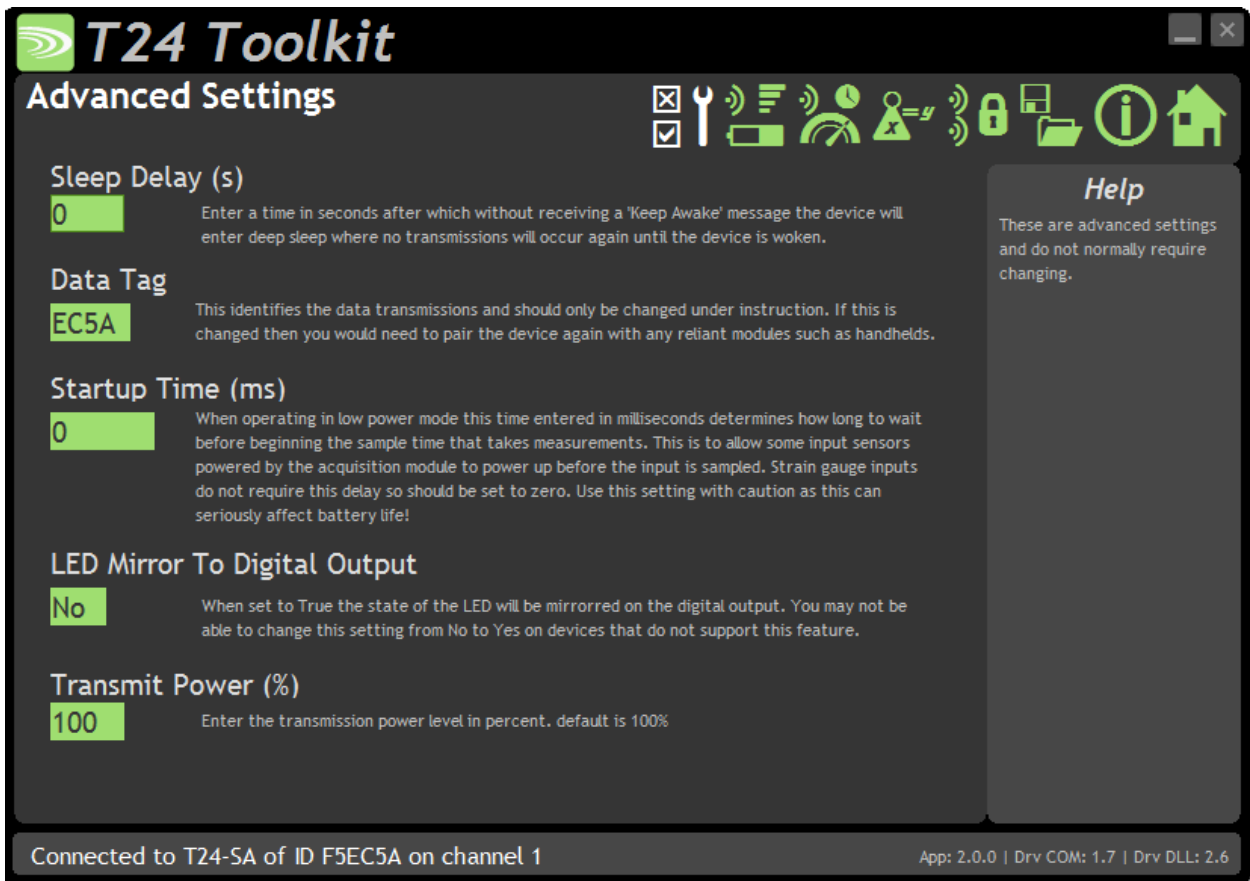

You should not normally need to change these settings.

**Items you can change:**

- Sleep Delay** Here you can enter a delay in seconds after which the transmitter module will return to deep sleep if no Keep Awake message is heard from the T24-HS handheld. The default is 60 seconds.
- Data Tag** The data transmitted by the module is identified by a Data Tag. This is by default set to the last 4 digits of the module serial number. If by some chance you had two transmitter module modules that would be working on the same channel and had the same last 4 characters in their ID (1 in 65,535 chances) you may want to change the data Tag of one of the modules and perform pairing again with the T24-HS handheld.
- Startup Time** Some transmitter modules power a sensor from their excitation voltage. When coupled to a sensor with a slow startup time this setting is used to delay the measurement after wakeup from sleep between readings. This gives the sensor time to settle at the expense of battery life. For strain gauge inputs this settings should be set to zero.
- LED Mirror to Digital Output** When set to Yes each time the LED is active the digital output is active. This can be useful if the module is to be encapsulated or enclosed and enables a second LED to be externally mounted. This is very useful when using a T24-HR roaming handheld as the transmitter module LED will activate while the handheld is in communications with the module.
- Transmit power** Set the transmit power level from 0 – 100%. Default is 100%

---

## Enclosure & Mounting

This module is available in a number of different enclosure types. Locate your module and follow the link to view dimensional and mounting information for that particular enclosure.

---

### T24-SAe, T24-SAi

These OEM modules are bare PCB modules. Please see [Appendix A – Enclosures & Mounting – OEM Transmitter Modules](#) for more information.

---

### T24-ACM-SA

This module is fitted inside our large enclosure. Please see [Appendix A – Enclosures & Mounting – ACM](#) for more information.

---

### T24-ACMi-SA

This module is fitted inside our medium enclosure. Please see [Appendix A – Enclosures & Mounting – ACMi](#) for more information.

---

### T24-ACMm-SA

This module is fitted inside our small enclosure. Please see [Appendix A – Enclosures & Mounting – ACMm](#) for more information.

---

## Antennas

---

### T24-SAi

This module uses an integrated chip antenna. See [Appendix B – Antennas – Internal Chip Antenna](#)

---

### T24-SAe

Only the T24-SAe module allows for the fitting of external antennas. The choices are:

T24-ANTA	PCB Antenna	See <a href="#">Appendix B – Antennas – T24-ANTA</a>
T24-ANTB	Dipole Antenna	See <a href="#">Appendix B – Antennas – T24-ANTB</a>
T24-ANTC	Dipole Antenna Swivel	See <a href="#">Appendix B – Antennas – T24-ANTC</a>
T24-ANTD	Puck Antenna SMA	See <a href="#">Appendix B – Antennas – T24-ANTD</a>
T24-ANTE	Puck Antenna UFL	See <a href="#">Appendix B – Antennas – T24-ANTE</a>

---

### T24-ACM-SA, T24-ACMi-SA, T24-ACMm-SA

These modules have the antenna already fitted inside the enclosure so there are no specific mounting requirements.

## Specification

Specification with 1000R bridge, 2.5mV/V, at 3V supply at 25°C

Measurement	Min	Typical	Max	Units
Strain Gauge Excitation System			4 Wire	
Strain Gauge Excitation Voltage	4.5	5	5.25	Vdc
Strain Gauge Drive Capability	85	-	5000	Ω
Maximum Gauge Sensitivity (FR)			3.2	+/-mV/V
Offset Temperature Stability		1	4	ppm/°C
Gain Temperature Stability		3	5	ppm/°C
Offset Stability with Time		20	80	ppm of FR (1)
Gain Stability with Time			30	ppm of FR (2)
Non Linearity before Linearization		5	25	ppm of FR
Internal Resolution		16,000,000/ 24		Resolution/Bits
Noise Free where Sample Time < 10ms		50,000 / 15.5		Resolution/Bits
Noise Free where Sample Time < 50ms		65,000 / 16		Resolution/Bits
Noise Free where Sample Time < 100ms		150,000 / 17.25		Resolution/Bits
Noise Free where Sample Time < 1000ms		250,000 / 18		Resolution/Bits
Noise Free where Sample Time > 1000ms		400,000 / 18.75		Resolution/Bits

1. From original offset at any time.
2. First year.

Environmental	Min	Typical	Max	Units
Operating temperature range	-20		+55	°C
Storage Temperature	-40		+85	°C
Humidity	0		95	%RH

Power Supply	Min	Typical	Max	Units
Standby / Low Power Mode		5	20	μA
<b>T24-SAe, T24-SAi, T24-ACMi-SA, T24-ACMm-SA</b>				
Power Supply voltage	2.1	3.0	3.6	Vdc
Power Supply ripple			50	mV ac pk-pk
Normal Mode (1K Bridge)		60	65	mA (1)
<b>T24-ACM-SA</b>				
Power Supply voltage	5		18	Vdc
Power Supply ripple			50	mV ac pk-pk
Normal Mode (1K Bridge)		60	65	mA (1)

1. Power supply must be capable of supplying 300 mA for 250 μs (Required on start up, waking and during low power operation)

Battery Life in Low Power Mode Generating Results at 3Hz with 350R Load Cell	Usage	Battery Life
Pair AA cells	Constantly on	3 weeks
Pair AA cells	12 sessions per day of 5 minutes	2 years
Pair D cells	Constantly on	3.5 months
Pair D cells	12 sessions per day of 5 minutes	5 years

---

## Radio Range

To determine radio range please refer to [Appendix B – Antenna Range](#)

---

## T24-ACM-SAf, T24-ACMi-SAf, T24-ACMm-SAf, T24-SAfe, T24-SAfi

---

### Overview

For high speed applications the T24-SAf provides measurements at 2 KHz with 200 packets per second containing 10 x 32 bit values representing nano volts/volt.

The T24-SAf will usually be used in conjunction with an analogue output module or for supplying data to a computer via a base station.

Please note that these modules are not suitable for use with T24 handheld displays.

---

### Order Codes

---

#### T24-SAfe



OEM strain transmitter module with external antenna UFL connector.

#### T24-SAfi



OEM strain transmitter module with integral antenna.

---

#### T24-ACM-SAf



Strain transmitter module mounted in large weatherproof enclosure with battery holder for two D cell alkaline batteries. Also has ability to be powered from external supply voltage.

#### T24-ACMi-SAf



Strain transmitter module mounted in medium weatherproof enclosure with battery holder for two AA batteries.

---

#### T24-ACMm-SAf



Strain transmitter module mounted in small enclosure with screw terminals to connect external 3V power supply.

---

---

## Connections

---

### T24-SAFe, T24-SAFi

---

#### Power

Attach power supply wiring to the module as shown below:

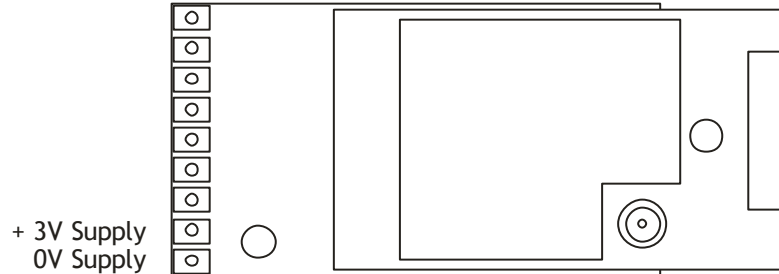

Connect to a 3 volt power supply or batteries.



This module is **not** reverse polarity protected! The maximum voltage is 3.6V!

For battery information please refer to [Appendix D – Battery Selection](#)

#### Sensor

Strain gauge connection is 4 wire as follows:

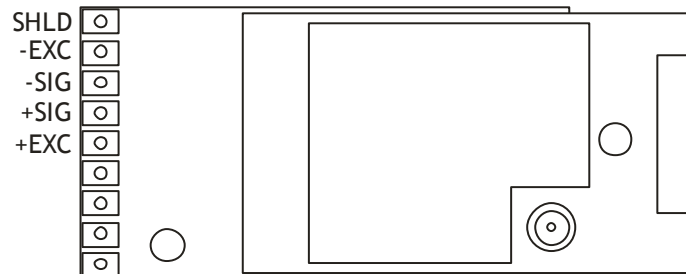

The resistance of the strain gauge can be between 85 and 5000 ohms. The T24-SAF can support up to 4 350 ohm strain gauges bridges attached in parallel (At the expense of reduced battery life).

The cable lengths between the T24-SA and the gauges should be kept below 3 meters and generally as short as possible.

As the measurement is 4 wire the longer the cable the more inaccurate the measurement from the factory mV/V calibration will be due to voltage drops in the cable.

The strain gauge measurement is bi-directional, i.e. tension & compression.

## T24-ACM-SAf

### Power

Power can be supplied by fitting two D cell alkaline 1.5 V batteries or the module can be supplied from an external 5 Vdc to 18 Vdc source.

In both cases you need to fit the JP1 power jumper to supply power to the transmitter module. When powered from the external DC source the LED will illuminate.

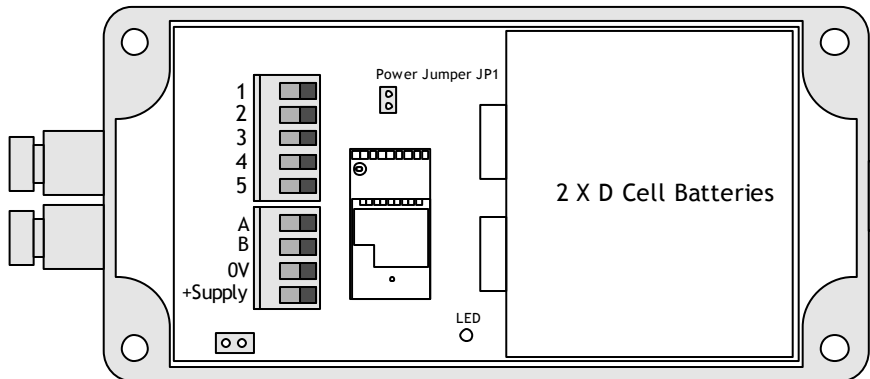

For battery information please refer to [Appendix D – Battery Selection](#)

### Sensor

The strain gauge input is connected to the module via a 2 part screw terminal block.

Screw Terminal	Function
1	+5 V Excitation
2	+Signal
3	-Signal
4	-Excitation
5	Shield
A	
B	

---

## T24-ACMi-SAf

---

### Power

The enclosure is designed to accept two AA batteries. Maximum voltage 1.8V per cell.

For battery information please refer to [Appendix D – Battery Selection](#)

---

### Sensor

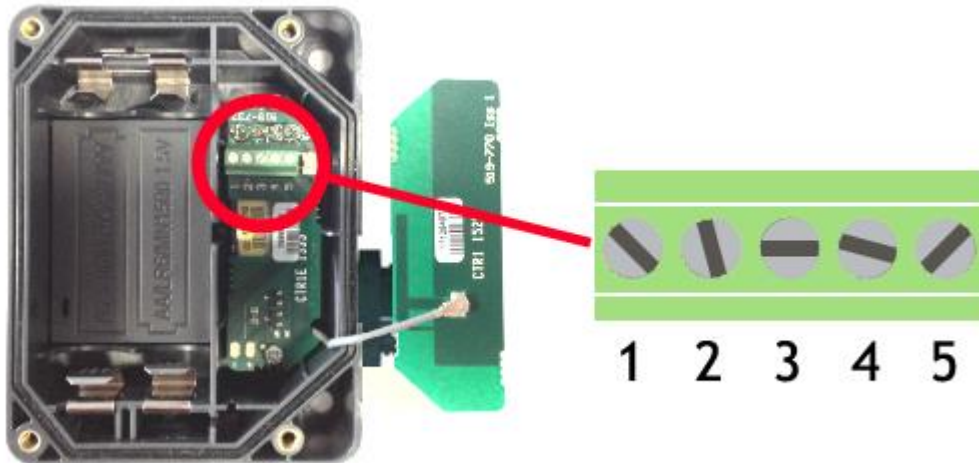

The input connections are accessed by lifting the right hand cover plate, this plate incorporates the T24-ACMi Antenna; take extra care when re-assembling that the grey UHF cable is attached to the antenna socket.

Screw Terminal	Function
1	Shield
2	- Excitation
3	-Signal
4	+Signal
5	+ 5 V Excitation



---

## T24-ACMm-SAf

---

### Power

Power is supplied by connecting a 3V supply to the first two screw terminals as shown below.

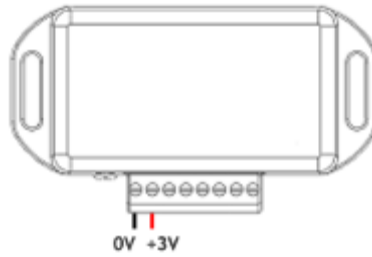

**!** There is no reverse polarity protection.

---

### Connecting T24-BB1

Power to transmitter modules in this enclosure can also be supplied by a T24-BB1 battery box which contains two AA 1.5 V batteries.

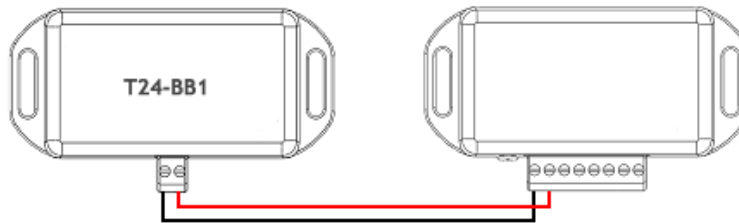

For battery information please refer to [Appendix D – Battery Selection](#)

---

### Sensor

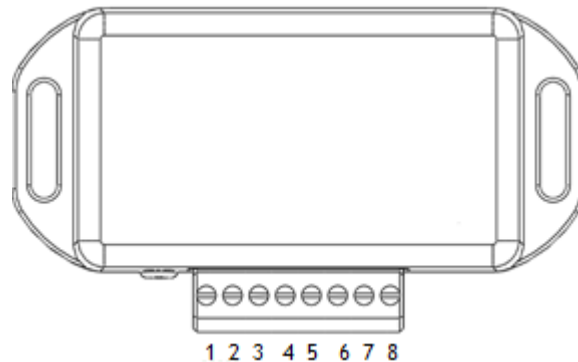

Screw Terminal	Function
5	-Excitation
6	-Signal
7	+Signal
8	+5 V Excitation

---

## Using Completion Resistors

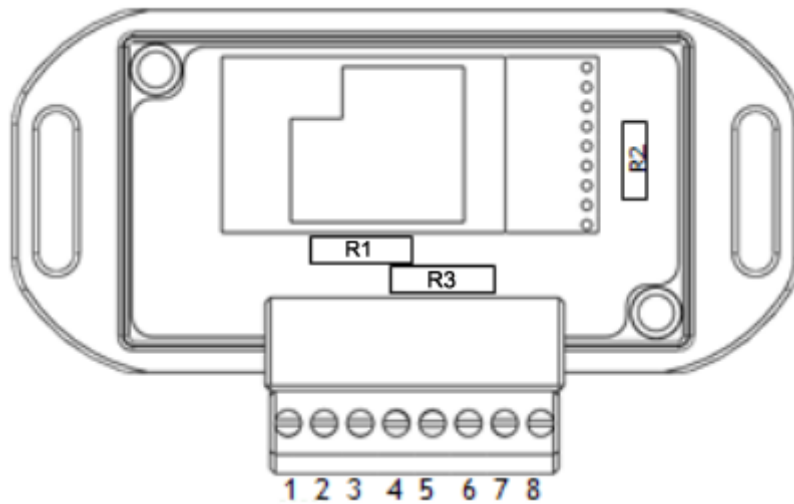

The T24-ACMm has the option for users to add up to three completion resistors, these can be used to enable the T24-ACMm to accept half and quarter bridge strain input when a strain transmitter module is fitted. The three completion resistors are located as shown below:

If using a half bridge only R1 and R2 need to be fitted, we recommend low drift precision resistors to ensure reading stability typically 0.1% 5ppm/°C. If using a quarter bridge R1, R2 and R3 must be fitted, R3 must be the same resistance as the single gauge being used in the quarter bridge. The diagram below shows how you should wire for full, half and quarter bridge configurations.

### Full Bridge

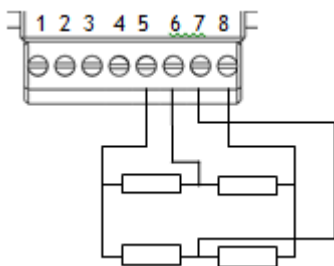

### Half Bridge

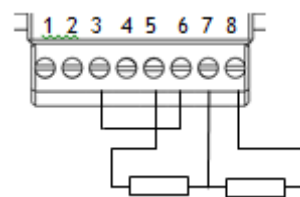

### Quarter Bridge

#### High Reference

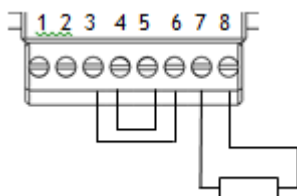

#### Low Reference

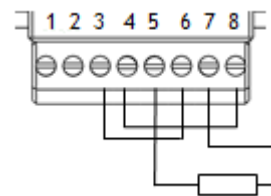

---

## Shield Connections (All Enclosures)

We recommend the following rules to determine whether there should be a connection between the transmitter module shield and the sensor chassis or cable:

1. If the sensor is remote to the transmitter module and the screen of the signal cable is **NOT** connected to the sensor chassis then the cable screen should be connected to the transmitter module shield connection.
2. If the sensor is remote to the transmitter module and the screen of the signal cable **IS** connected to the sensor chassis then the cable screen should be **NOT** connected to the transmitter module shield connection.
3. If the transmitter module is integral to the sensor or mounted very close and the module is mounted on a metal chassis then the answer to whether the transmitter module shield connection should be connected to the metal chassis is a matter of experimentation. This connection must be as short as possible. The T24 Toolkit can be used to chart the signal levels and tests should be undertaken to determine whether there is a better radio signal with or without the shield/chassis connection. The quality of the measured reading should also be looked at. In cases where the shield/chassis connection makes no difference to the radio signal or the reading quality then the connection should be made.

---

## Configuration

The T24 Toolkit provides a means of simple configuration of the transmitter module along with useful tools to aid integration.

**!** NOTE: The T24-SAf has a fixed nV/V output and cannot be calibrated!

Launch the T24 Toolkit software application and pair to this module to enable the connection to the Toolkit to allow configuration to take place. [See Common Toolkit Pages - Home](#)

---

## Battery Life

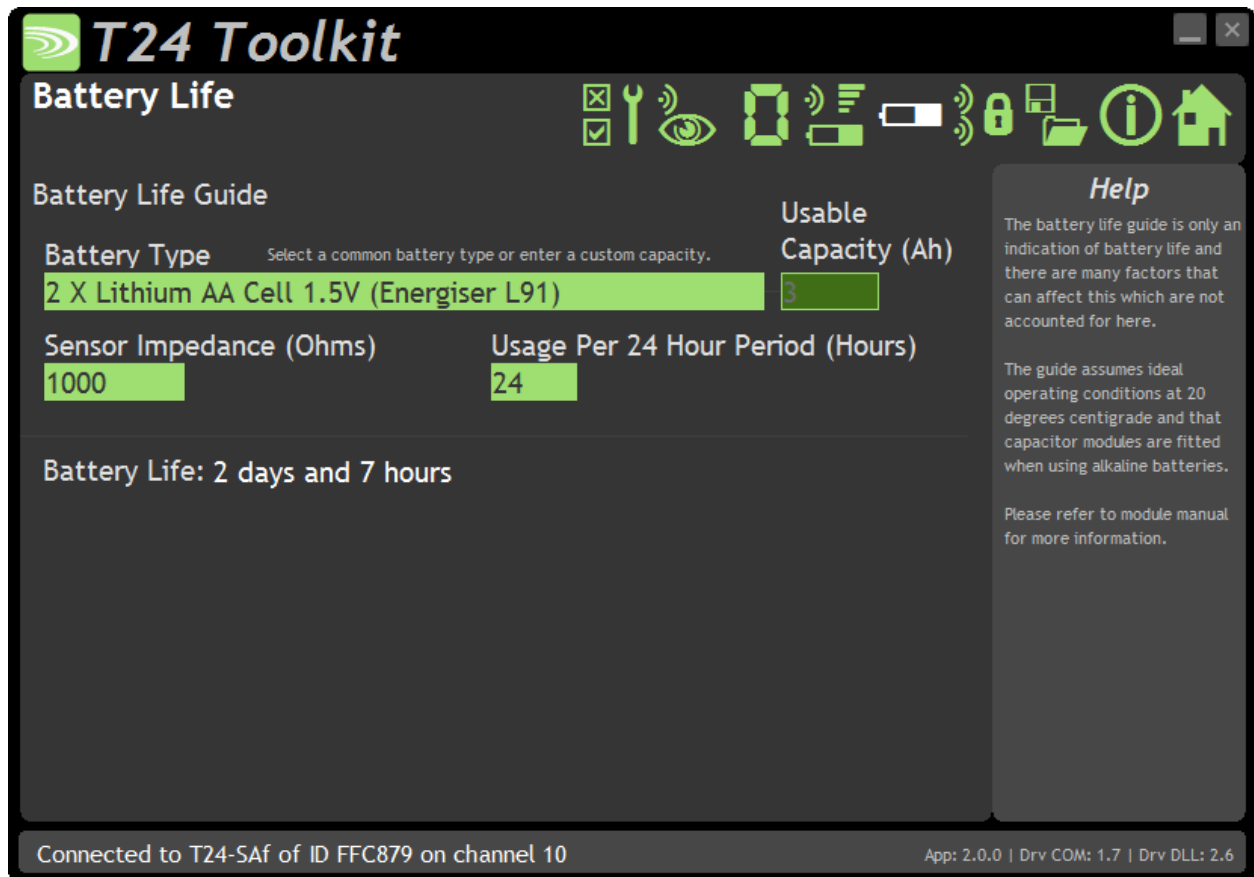

This page gives guides on achievable battery life.

Note that the battery life calculator is assuming the best case scenario which is at 20°C and that the battery has a suitable low internal resistance or that a suitable capacitor is fitted across the battery. See battery details in the Installation section.

### Items you can change:

#### Battery Type

This is not a parameter of the module but information used by the battery life guide. You can choose from some preset batteries or choose custom to allow you to select your own battery capacity. See below. This will also offer to change the Battery Low Level if the level suitable for the chosen battery is not the level currently set.

#### Usable Capacity

This is not a parameter of the module but information used by the battery life guide. This is the capacity of the battery in Amp Hours and has a profound effect on battery life calculations. This capacity needs to be calculated from battery manufacturer's data sheets to take into account that you can only use batteries down to 2.1 volts so in the case of twin AA cells this would be 1.05

volts.

Generally the usable capacity will not be as high as that advertised by the battery manufacturer. Temperature and internal resistance of the battery are not taken into account in the guide.

Sensor Impedance

This is only available for certain transmitter modules. This is not a parameter of the module but information used by the battery life guide. Enter the resistance of the connected strain gauge in Ohms.

Usage Per 24 Hour Period

Enter the number of hours per 24 hour period that the T24-SAf will be turned on and communicating.

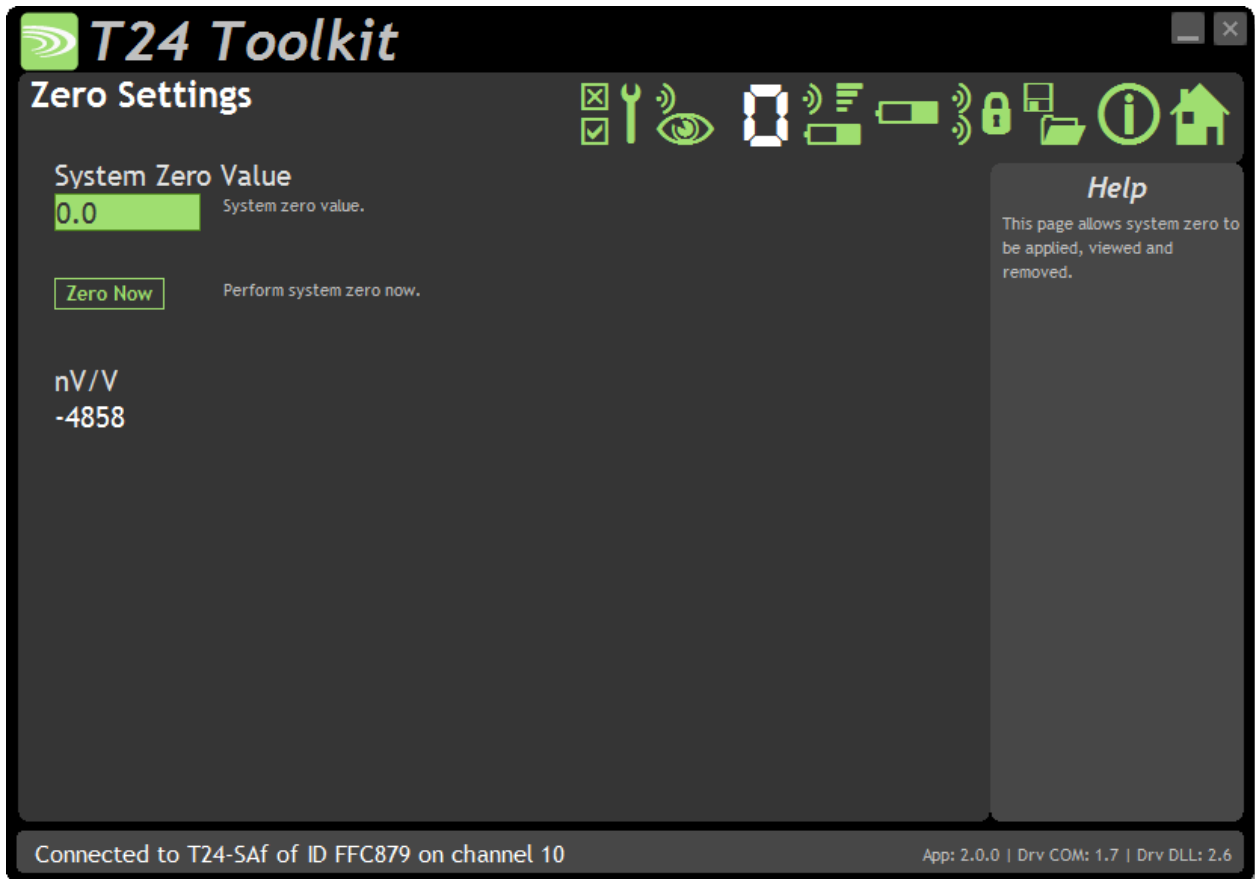

Although there is no calibration functionality in the T24-SAf there is the ability to zero the output value.

**Items you can change:**

- |                   |   |
|-------------------|---|
| System Zero Value | Enter a value which will be subtracted from the current nV/V value. Used to zero the value. |
| Zero Now          | Zero the value now by placing the current value into the System Zero value.                 |

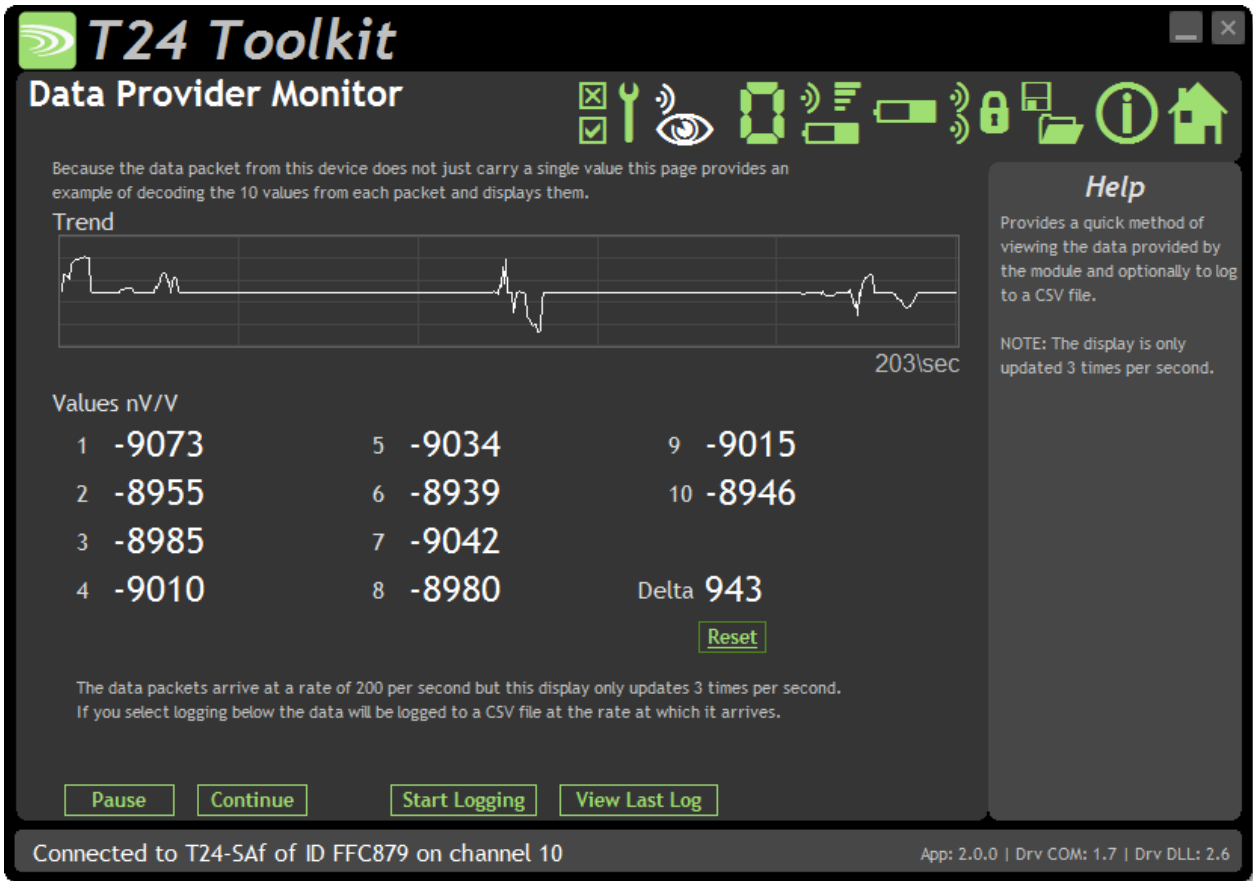

Because the standard data provider monitor does not decode correctly the multiple data packets from as T24-SAf this special page provides a trend chart and a view of all 10 readings contained in each packet. It also shows a delta value (Max – min) and allows you to log the data to a file.

**Items you can change:**

- Reset    Clicking here will reset the Delta display to zero.
- Pause    Stop the module transmitting data.
- Continue    Continue with data transmission.
- Start Logging                                    Allows you to select a filename and starts to log the data to the selected file. The format of the file is CSV and the columns are:

**`Elapsed,Value <carriage Return>`**

Where

**Elapsed** is a timestamp counter provided by the T24-SAf. Each unit represents 500uS and the number will reset to zero every 32.768 seconds. This timestamp aids in spotting lapses in data and allows graphing data even with dropped packets.

**Value** is the value logged.

- View Last Log                                    The same button is used to stop the logging. Once logging has stopped clicking this will open the log file in the program associated with the .csv file extension.

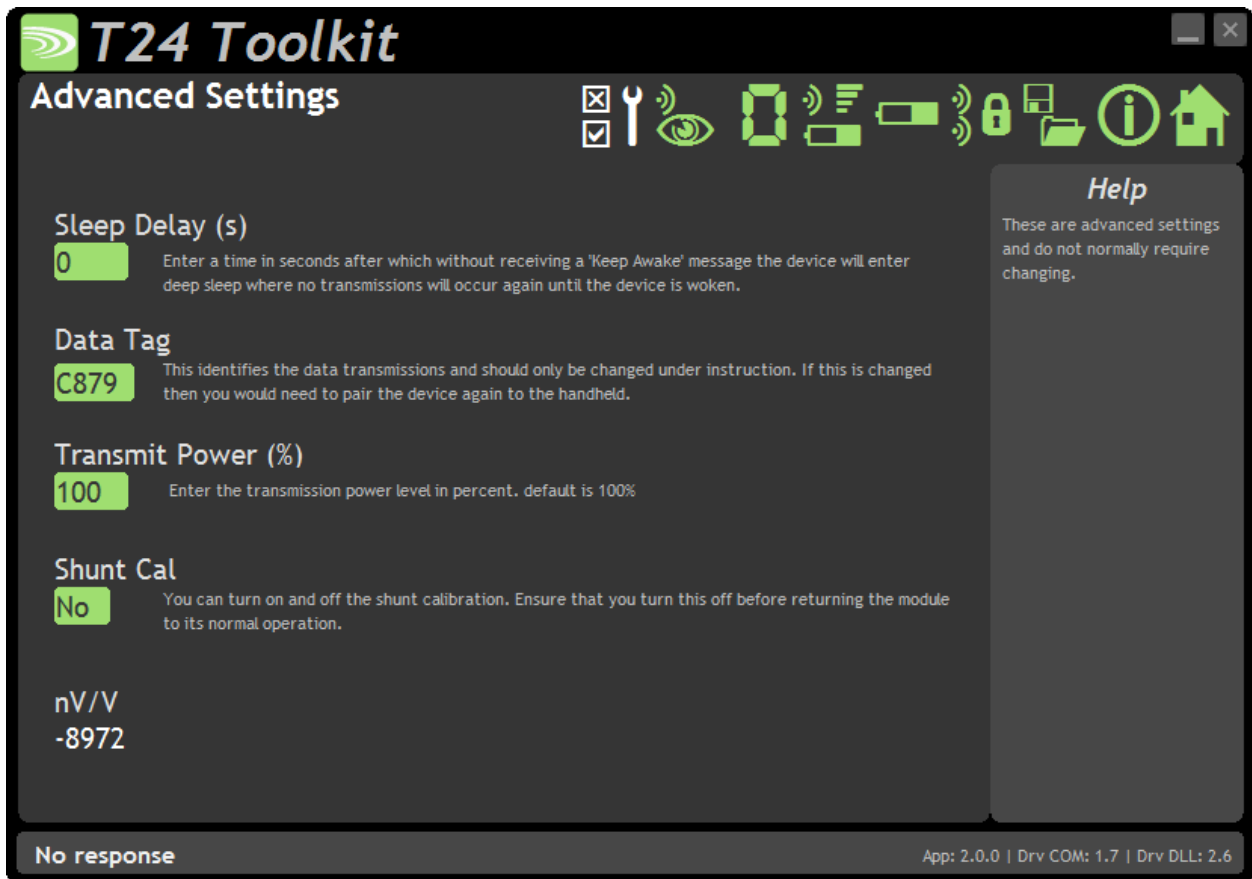

You should not normally need to change these settings.

#### Items you can change:

Sleep Delay

Here you can enter a delay in seconds after which the transmitter module will return to deep sleep if no Keep Awake message is heard from another T24 module such as an analogue output module. The default is 60 seconds.

Data Tag

The data transmitted by the transmitter module is marked with a Data Tag which is a 2 byte hexadecimal code. By default this is set to the last 2 bytes of the module ID (or to put it another way, the last 4 characters of the module ID). If by some chance you had two transmitter module modules that would be working on the same channel and had the same last 4 characters in their ID (1 in 65,535 chances) you may want to change the data Tag of one of the modules and perform pairing again with the associated T24 module.

Transmit power

Set the transmit power level from 0 – 100%. Default is 100%

Shunt Cal

Allows turning on or off the application of a shunt calibration resistor to the bridge input.  
You must remember to turn this off before exiting the Toolkit software.

nV/V

Shows the output value so the effect of the Shunt Cal can be seen.



---

## Enclosure & Mounting

This module is available in a number of different enclosure types. Locate your module and follow the link to view dimensional and mounting information for that particular enclosure.

---

### T24-SAfe, T24-SAfi

These OEM modules are bare PCB modules. Please see [Appendix A – Enclosures & Mounting – OEM Transmitter Modules](#) for more information.

---

### T24-ACM-SAf

This module is fitted inside our large enclosure. Please see [Appendix A – Enclosures & Mounting – ACM](#) for more information.

---

### T24-ACMi-SAf

This module is fitted inside our medium enclosure. Please see [Appendix A – Enclosures & Mounting – ACMi](#) for more information.

---

### T24-ACMm-SAf

This module is fitted inside our small enclosure. Please see [Appendix A – Enclosures & Mounting – ACMm](#) for more information.

---

## Antennas

---

### T24-SAfi

This module uses an integrated chip antenna. See [Appendix B – Antennas – Internal Chip Antenna](#)

---

### T24-SAfe

Only the T24-SAfe module allows for the fitting of external antennas. The choices are:

T24-ANTA	PCB Antenna	See <a href="#">Appendix B – Antennas – T24-ANTA</a>
T24-ANTB	Dipole Antenna	See <a href="#">Appendix B – Antennas – T24-ANTB</a>
T24-ANTC	Dipole Antenna Swivel	See <a href="#">Appendix B – Antennas – T24-ANTC</a>
T24-ANTD	Puck Antenna SMA	See <a href="#">Appendix B – Antennas – T24-ANTD</a>
T24-ANTE	Puck Antenna UFL	See <a href="#">Appendix B – Antennas – T24-ANTE</a>

---

### T24-ACM-SAf, T24-ACMi-SAf, T24-ACMm-SAf

These modules have the antenna already fitted inside the enclosure so there are no specific mounting requirements.

## Specification

Specification with 1000R bridge, 2.5mV/V, at 3V supply at 25°C

Measurement	Min	Typical	Max	Units
Strain Gauge Excitation System			4 Wire	
Strain Gauge Excitation Voltage	4.5	5	5.25	Vdc
Strain Gauge Drive Capability	85	-	5000	Ω
Maximum Gauge Sensitivity (FR)			3.2	+/-mV/V
Offset Temperature Stability		1	4	ppm/C
Gain Temperature Stability		3	5	ppm/C
Offset Stability with Time		20	80	ppm of FR (1)
Gain Stability with Time			30	ppm of FR (2)
Non Linearity Before Linearization		5	25	ppm of FR
Internal Resolution		16,000,000/ 24		Resolution/Bits
Noise free Resolution (10 second sample period)		8000/13		Resolution/Bits

1. From original offset at any time.
2. First year.

Environmental	Min	Typical	Max	Units
Operating Temperature Range	-20		+55	°C
Storage Temperature	-40		+85	°C
Humidity	0		95	%RH

Power Supply	Min	Typical	Max	Units
Standby / Low Power Mode		5	20	μA
<b>T24-SAfe, T24-SAfi, T24-ACMi-SAf, T24-ACMm-SAf</b>				
Power Supply voltage	2.1	3.0	3.6	Vdc
Power Supply ripple			50	mV ac pk-pk
Normal Mode (1K Bridge)		70	75	mA (1)
<b>T24-ACM-SAf</b>				
Power Supply voltage	5		18	Vdc
Power Supply ripple			50	mV ac pk-pk
Normal Mode (1K Bridge)		70	75	mA (1)

1. Power supply must be capable of supplying 300 mA for 250 μs (Required on start up, waking and during low power operation)

Battery Life in Low Power Mode Generating Results at 3Hz with 350R Load Cell	Usage	Battery Life
Pair AA cells	Constantly on	30 hours
Pair AA cells	12 sessions per day of 5 minutes	30 days
Pair D cells	Constantly on	5.5 days
Pair D cells	12 sessions per day of 5 minutes	4.5 months

## Radio Range

To determine radio range please refer to [Appendix B – Antenna Range](#)

---

## T24-ACM-VA, T24-ACMi-VA, T24-ACMm-VA, T24-VAe, T24-VAi

---

### Overview

The T24-VA module provides wireless voltage measurement for an input range of 0 to 10 volts. Suitable for a range of 0-10 V sensors including pressure, inclinometer, accelerometer, temperature & displacement. Provides 5 V sensor power.

---

### Order Codes

---

#### T24-VAe



Voltage transmitter module with external antenna UFL connector.

#### T24-VAi



Voltage transmitter module with integral antenna.

---

#### T24-ACM-VA



Voltage transmitter module mounted in large weatherproof enclosure with battery holder for two D cell alkaline batteries. Also has ability to be powered from external supply voltage.

#### T24-ACMi-VA



Voltage transmitter module mounted in medium weatherproof enclosure with battery holder for two AA batteries.

---

#### T24-ACMm-VA



Voltage transmitter module mounted in small enclosure with screw terminals to connect external 3V power supply.

---

---

## Connections

---

### T24-VAe, T24-VAi

---

#### Power

Attach power supply wiring to the module as shown below:

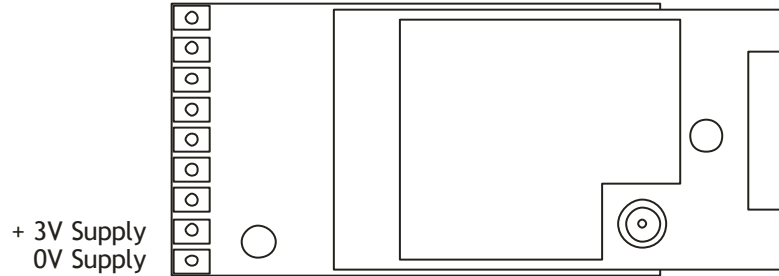

Connect to a 3 Volt power supply or batteries.



This module is **not** reverse polarity protected!  
The maximum voltage is 3.6V!

For battery information please refer to [Appendix D – Battery Selection](#)

---

#### Sensor

Voltage input connected as follows:

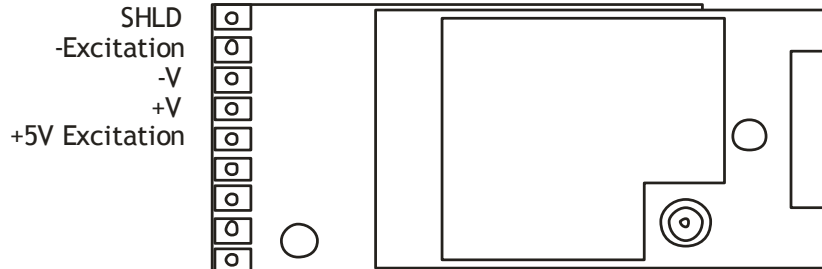

## T24-ACM-VA

### Power

Power can be supplied by fitting two D cell alkaline 1.5 V batteries or the module can be supplied from an external 5 Vdc to 18 Vdc source.

In both cases you need to fit the JP1 power jumper to supply power to the transmitter module. When powered from the external DC source the LED will illuminate.

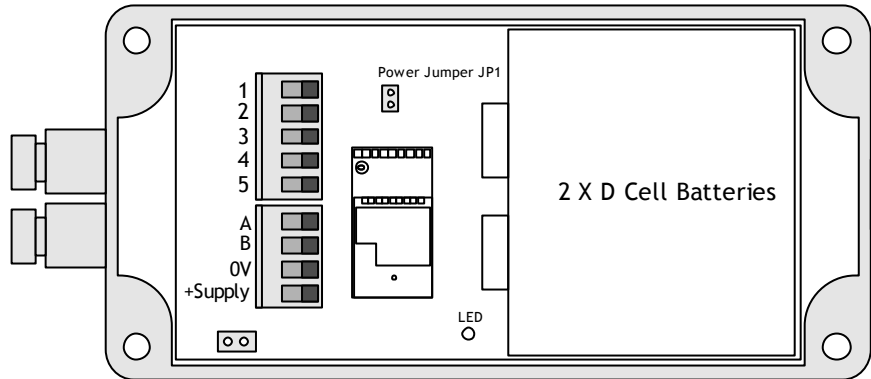

For battery information please refer to [Appendix D – Battery Selection](#)

### Sensor

The voltage input is connected to the module via a 2 part screw terminal block.

Screw Terminal	Function
1	+5 V Excitation
2	+V
3	-V
4	-Excitation
5	Shield
A	
B	

---

## T24-ACMi-VA

---

### Power

The enclosure is designed to accept two AA batteries. Maximum voltage 1.8V per cell.

For battery information please refer to [Appendix D – Battery Selection](#)

---

### Sensor

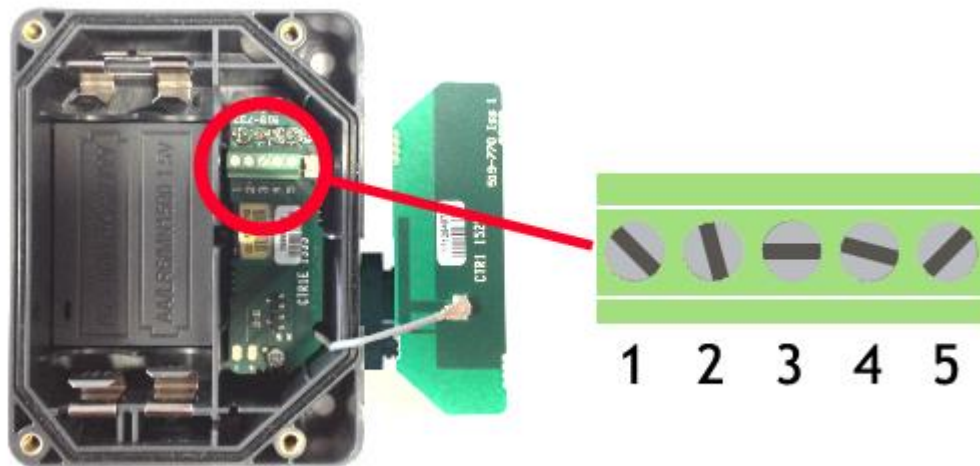

The input connections are accessed by lifting the right hand cover plate, this plate incorporates the T24-ACMi Antenna; take extra care when re-assembling that the grey UHF cable is attached to the antenna socket.

Screw Terminal	Function
1	Shield
2	-Excitation
3	-V in
4	+V in
5	+ 5 V Excitation

---

## T24-ACMm-VA

---

### Power

Power is supplied by connecting a 3V supply to the

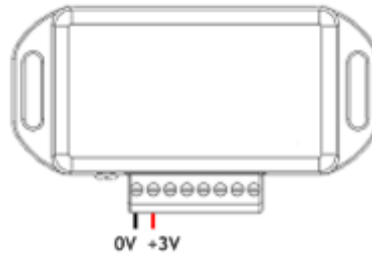

 There is no reverse polarity protection.

---

### Connecting T24-BB1

Power to transmitter modules in this enclosure can also be supplied by a T24-BB1 battery box which contains two AA 1.5 V batteries.

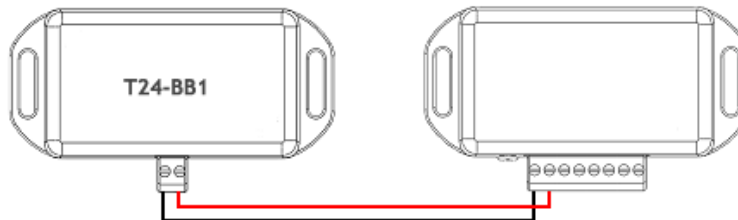

For battery information please refer to [Appendix D – Battery Selection](#)

---

### Sensor

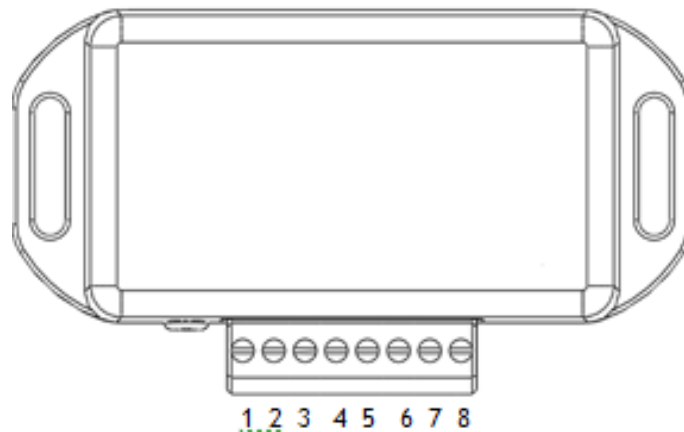

Screw Terminal	Function
5	-Excitation
6	-V in
7	+V in
8	+5 V Excitation

---

---

## Shield Connections (All Enclosures)

We recommend the following rules to determine whether there should be a connection between the transmitter module shield and the sensor chassis or cable:

1. If the sensor is remote to the transmitter module and the screen of the signal cable is **NOT** connected to the sensor chassis then the cable screen should be connected to the transmitter module shield connection.
2. If the sensor is remote to the transmitter module and the screen of the signal cable **IS** connected to the sensor chassis then the cable screen should be **NOT** connected to the transmitter module shield connection.
3. If the transmitter module is integral to the sensor or mounted very close and the module is mounted on a metal chassis then the answer to whether the transmitter module shield connection should be connected to the metal chassis is a matter of experimentation. This connection must be as short as possible. The T24 Toolkit can be used to chart the signal levels and tests should be undertaken to determine whether there is a better radio signal with or without the shield/chassis connection. The quality of the measured reading should also be looked at. In cases where the shield/chassis connection makes no difference to the radio signal or the reading quality then the connection should be made.



## Configuration

The T24 Toolkit provides a means of simple configuration and calibration of the transmitter module along with useful tools to aid integration.

Launch the T24 Toolkit software application and pair to this module to enable the connection to the Toolkit to allow configuration to take place. [See Common Toolkit Pages - Home](#)

## Data Rates and Quality

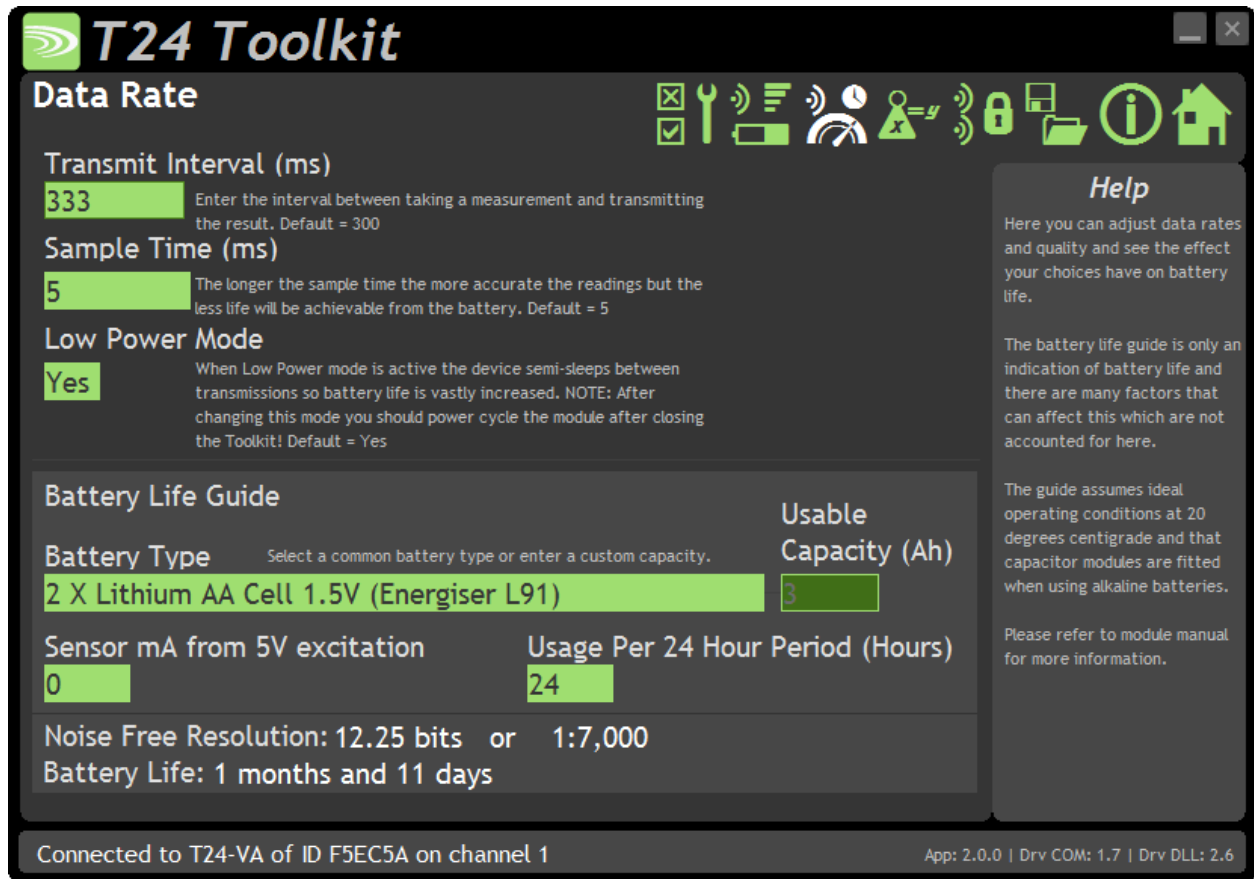

This page allows you to select the rate at which data is transmitted from the transmitter module and the quality. By selecting low power mode and entering some other information the toolkit will also give guides on achievable battery life.

Note that the battery life calculator is assuming the best case scenario which is at 20°C and that the battery has a suitable low internal resistance or that a suitable capacitor is fitted across the battery. See battery details in the Installation section.

### Items you can change:

Transmit Interval

Enter the transmission rate in milliseconds. The default is 300 giving approximately 3 per second which is ideally suited to reading on a handheld. You may want to slow this down to achieve longer battery life.

Sample Time

This is the length of time in milliseconds that the input is sampled before the value is transmitted. This can vary between 5 milliseconds and close to the Transmit Interval. A shorter sample time means that the module is awake for less time so battery life is increased but at the expense of a reading with less noise free resolution. You can vary this to see the effect on battery life and noise free resolution.

Low Power Mode	<p>Unless the transmitter module is non battery powered this should be set to Yes. In between transmissions the transmitter module will enter sleep mode which, for some modules such as the strain gauge transmitter module, will have a massive effect on battery life.</p> <p>A Reason for <b>not</b> using Low Power Mode would be if using the module in a Master-Slave arrangement with PC for example.</p>
Battery Type	<p>This is not a parameter of the module but information used by the battery life guide. You can choose from some preset batteries or choose custom to allow you to select your own battery capacity. See below. This will also offer to change the Battery Low Level if the level suitable for the chosen battery is not the level currently set.</p>
Usable Capacity	<p>This is not a parameter of the module but information used by the battery life guide. This is the capacity of the battery in Amp Hours and has a profound effect on battery life calculations. This capacity needs to be calculated from battery manufacturer's data sheets to take into account that you can only use batteries down to 2.1 volts so in the case of twin AA cells this would be 1.05 volts.</p> <p>Generally the usable capacity will not be as high as that advertised by the battery manufacturer. Temperature and internal resistance of the battery are not taken into account in the guide.</p>
Sensor Resistance	<p>This is only available for certain transmitter modules. This is not a parameter of the module but information used by the battery life guide. Enter the resistance of the connected strain gauge in Ohms.</p>
Usage Per 24 Hour Period	<p>Enter the number of hours per 24 hour period that the T24-HS handheld will be turned on and communicating with a transmitter module.</p>

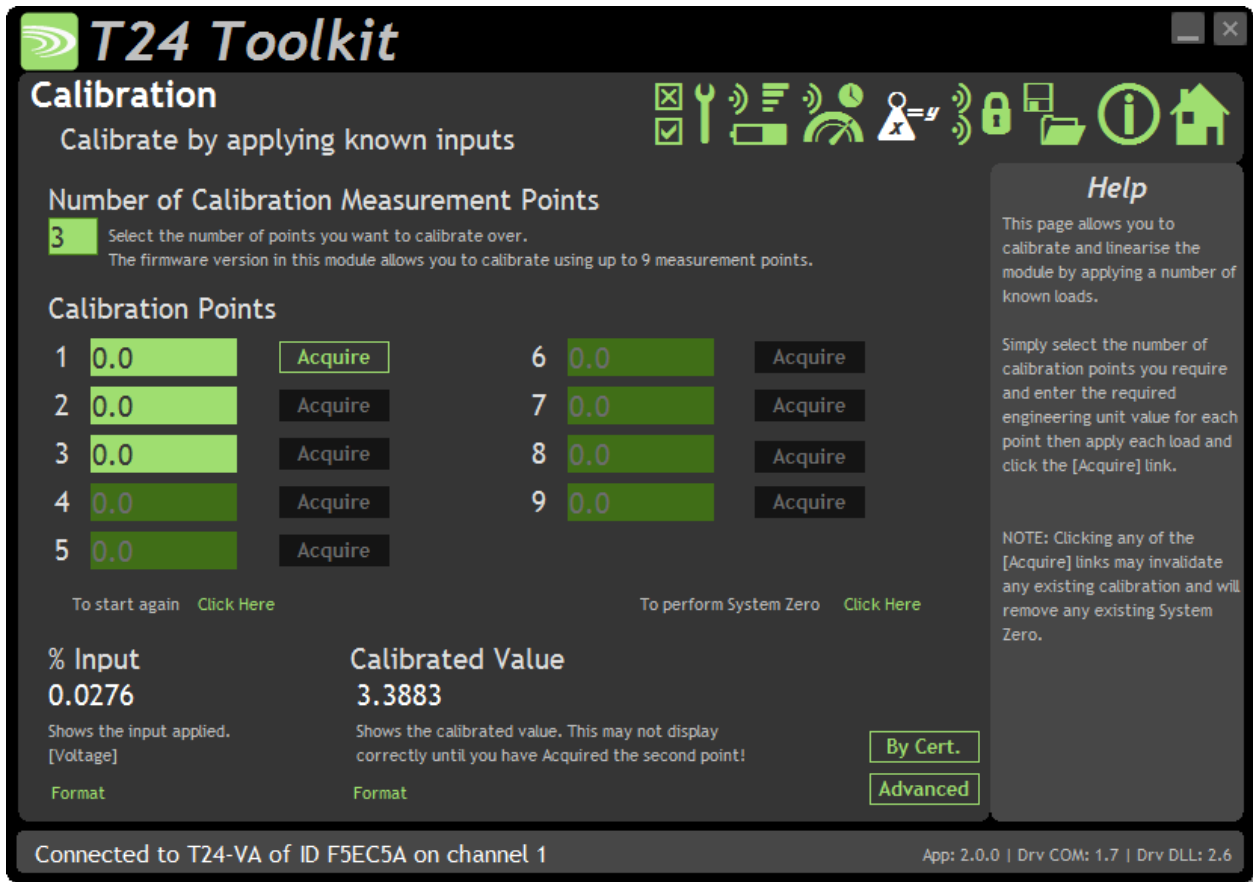

Here you can calibrate the transmitter module and set a system zero if required. This simple page allows semi-automated calibration where you can apply known inputs to calibrate. This calibration includes linearization and is automatically applied. See later for **By Cert** and **Advanced** page where you can adjust individual gains and offsets.

**Calibration Process**

- Decide on how many points you will calibrate over.
- Decide what voltage inputs will be applied (in ascending order) at each point.
- Enter the actual input (in the required units) that you want the module to read at each point.
- Now proceed to apply each input in turn (allowing a settle time) and click the **Acquire** button at that point. You can now apply the next input and click **Acquire** until all the points are completed.

**i** The voltage input must be ascending through each calibration point.

The bottom of the page shows the **Input Value** and the **Calibrated Value**. Once the second point has been acquired this **Calibrated Value** should display the actual calibrated value.

**Items you can change:**

Number of Calibration Points    Enter the number of points you wish to calibrate over. In its simplest form you could select two for a linear calibration. For more complex calibrations which include linearization select three to nine points.

Point 1 - 9    For each point enter the engineering unit value that you want the transmitter module to report at the applied input. i.e. 1.67

Acquire 1 - 9	Click this button when the input has been applied and the reading has been allowed to settle. This will acquire the reading and allow you to move to the next points. You will be able to click the button again to re-acquire.
Start Again	Click here to restart the calibration.
System Zero	Once calibrated you may want to remove a fixed system value. In the case of a strain gauge input this may be the weight of a sling, shackle, load bed etc. Apply the required input and click here to set the system zero. The current input will be removed from subsequent readings so that the reading will be zero. To edit this value manually click the <b>Advanced</b> button. System Zero is stored in non-volatile memory in the transmitter module.
By Cert.	You can click the <b>By Cert</b> button to calibrate against a sensor calibration sheet. You just need to enter the input values and associated engineering unit required output value of at least 2 points. This will take you to a different screen.
Advanced	Clicking the advanced button will allow you to edit the gains and offsets for each available calibration point. This will take you to a different screen.

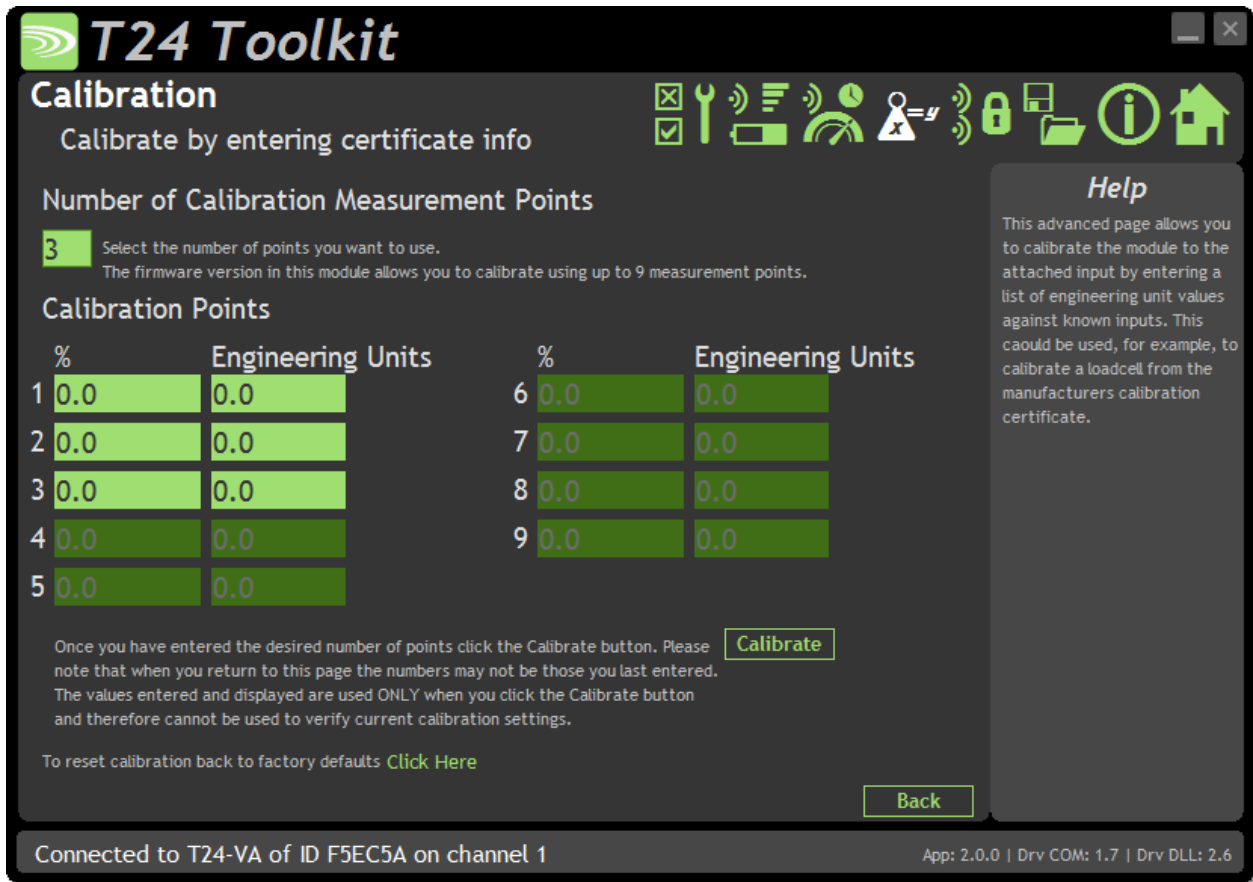

In some circumstances it may not be possible to apply inputs in which case the calibration can be entered manually from a calibration table.

**Items you can change:**

**Number of Calibration Points** Enter the number of points you wish to calibrate over. In its simplest form you could select two for a linear calibration. For more complex calibrations which include linearization select three to nine points.

**Input Points 1 – 9** Enter the % input point for which you will specify a required engineering output value. These modules are factory calibrated where 0% = 0 V and 100% = 10 V

**Engineering Units 1 - 9** Enter the required engineering unit output for the specified input value

**Calibrate** Click this button to calculate and update the module calibration

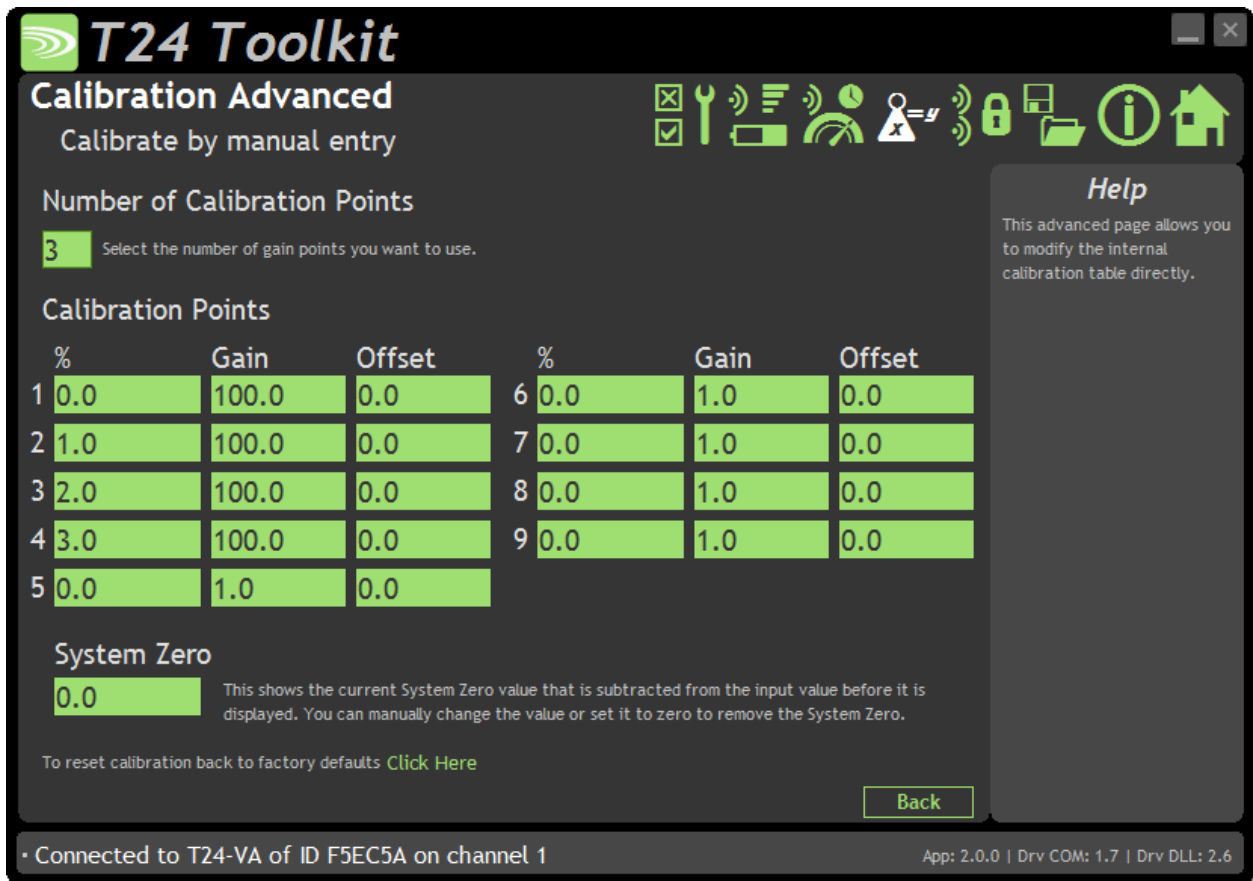

In some circumstances it may not be possible to apply inputs in which case the calibration can be entered manually.

**Items you can change:**

- Number of Calibration Points Enter the number of points you wish to calibrate over. In its simplest form you could select two for a linear calibration. For more complex calibrations which include linearization select three to nine points.
- Input Points 1 – 9 Enter the % input point to which the associated interpolated gain and offset values will be applied. Note between points the gain and offset values are linearly interpolated. Inputs are extrapolated below point 1 and above point 9.
- Gain 1 - 9 Enter the gain value for associated point
- Offset 1 - 9 Enter the Offset value for associated point
- System Zero You can set the system zero value here or set it to zero to remove the system zero effect.

**Description of Linearisation Calculations**

The input value is looked up in a table of points which is dependent on what the user has selected, starting from the bottom of the table. When a point is found to which the input is less than then this point and the previous point are used to extrapolate a gain and offset from. This leads to a resultant gain and offset which is applied to the mV/V values as follows.

$$\text{Value} = (\text{input} * \text{Resultant Gain}) - \text{Resultant Offset}.$$



---

## Enclosure & Mounting

This module is available in a number of different enclosure types. Locate your module and follow the link to view dimensional and mounting information for that particular enclosure.

---

### T24-VAe, T24-VAi

These OEM modules are bare PCB modules. Please see [Appendix A – Enclosures & Mounting – OEM Transmitter Modules](#) for more information.

---

### T24-ACM-VA

This module is fitted inside our large enclosure. Please see [Appendix A – Enclosures & Mounting – ACM](#) for more information.

---

### T24-ACMi-VA

This module is fitted inside our medium enclosure. Please see [Appendix A – Enclosures & Mounting – ACMi](#) for more information.

---

### T24-ACMm-VA

This module is fitted inside our small enclosure. Please see [Appendix A – Enclosures & Mounting – ACMm](#) for more information.



---

## Antennas

---

### T24-VAi

This module uses an integrated chip antenna. See [Appendix B – Antennas – Internal Chip Antenna](#)

---

### T24-VAe

Only the T24-VAe module allows for the fitting of external antennas. The choices are:

T24-ANTA	PCB Antenna	See <a href="#">Appendix B – Antennas – T24-ANTA</a>
T24-ANTB	Dipole Antenna	See <a href="#">Appendix B – Antennas – T24-ANTB</a>
T24-ANTC	Dipole Antenna Articulated	See <a href="#">Appendix B – Antennas – T24-ANTC</a>
T24-ANTD	Puck Antenna SMA	See <a href="#">Appendix B – Antennas – T24-ANTD</a>
T24-ANTE	Puck Antenna UFL	See <a href="#">Appendix B – Antennas – T24-ANTE</a>

---

### T24-ACM-VA, T24-ACMi-VA, T24-ACMm-VA

These modules have the antenna already fitted inside the enclosure so there are no specific mounting requirements.

## Specification

Specification at 3V supply at 25°C

Measurement	Min	Typical	Max	Units
Input Range Sensitivity (FR)	0	-	10	Vdc
Offset Temperature Stability		-	0.5	ppm/°C
Gain Temperature Stability		-	50	ppm/°C
Non Linearity before Linearization		5	25	ppm of FR
Internal Resolution		16,000,000/ 24		Resolution/Bits
Input Impedance	-	100,000	-	Ω
Input Calibration Accuracy	-	-	0.1	%FR
Noise Free where Sample Time < 10ms		5,000 / 12.25		Resolution/Bits
Noise Free where Sample Time < 100ms		8,000 / 13.0		Resolution/Bits
Noise Free where Sample Time < 1000ms		11,000 / 13.5		Resolution/Bits
Noise Free where Sample Time > 1000ms		15,000 / 13.75		Resolution/Bits

Environmental	Min	Typical	Max	Units
Operating Temperature Range	-20		+55	°C
Storage Temperature	-40		+85	°C
Humidity	0		95	%RH

Power Supply	Min	Typical	Max	Units
Standby / Low Power Mode		5	20	μA
Normal Mode on constantly		40	45	mA
<b>T24-VAe, T24-VAi, T24-ACMi-VA, T24-ACMm-VA</b>				
Power Supply voltage	2.1	3.0	3.6	Vdc
Power Supply ripple			50	mV ac pk-pk
Normal Mode		60	65	mA (1)
<b>T24-ACM-VA</b>				
Power Supply voltage	5		18	Vdc
Power Supply ripple			50	mV ac pk-pk
Normal Mode		60	65	mA (1)

1. Power supply must be capable of supplying 300 mA for 250 μs (Required on start up, waking and during low power operation)

Battery Life in Low Power Mode Generating Results at 3Hz	Usage	Battery Life
Pair AA cells	Constantly on	1 month
Pair AA cells	12 sessions per day of 5 minutes	2 years
Pair D cells	Constantly on	4.5 months
Pair D cells	12 sessions per day of 5 minutes	> 9 years

## Radio Range

To determine radio range please refer to [Appendix B – Antenna Range](#)

---

# T24-ACM-IA, T24-ACMi-IA, T24-ACMm-IA, T24-IAe, T24-IAi

---

## Overview

The T24-IA module provides wireless current measurement for an input range of 0-20 mA. Suitable for a range of 4-20 mA sensors such as pressure, inclinometer, accelerometer, temperature & displacement.

Provides 5 V sensor power.

---

## Order Codes

---

### T24-IAe



Current transmitter module with external antenna UFL connector.

### T24-IAi



Current transmitter module with integral antenna.

---

### T24-ACM-IA



Current transmitter module mounted in large weatherproof enclosure with battery holder for two D cell alkaline batteries. Also has ability to be powered from external supply voltage.

### T24-ACMi-IA



Current transmitter module mounted in medium weatherproof enclosure with battery holder for two AA batteries.

---

### T24-ACMm-IA



Current transmitter module mounted in small enclosure with screw terminals to connect external 3 V power supply.

---

---

## Connections

---

### T24-IAe, T24-IAi

---

#### Power

Attach power supply wiring to the module as shown below:

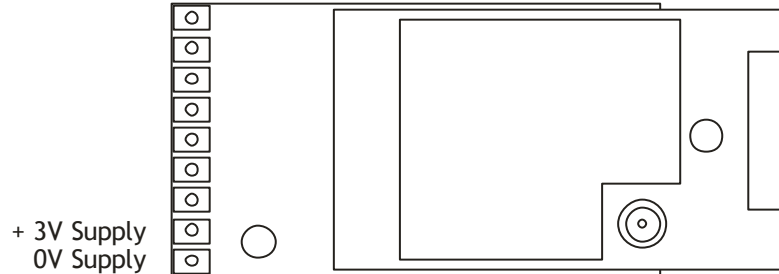

Connect to a 3 V power supply or batteries.

**!** This module is **not** reverse polarity protected!  
The maximum voltage is 3.6 V!

For battery information please refer to [Appendix D – Battery Selection](#)

---

#### Sensor

Voltage input connected as follows:

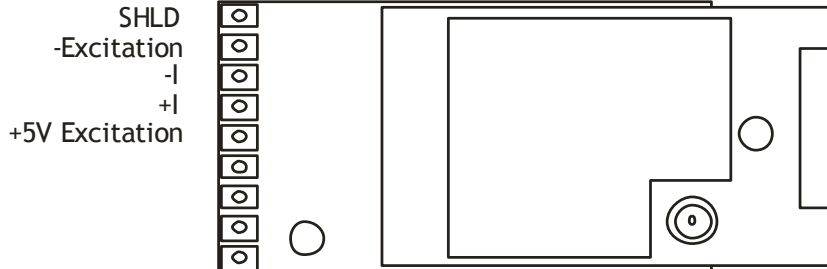

---

### T24-ACM-IA

---

#### Power

Power can be supplied by fitting two D cell alkaline 1.5 V batteries or the module can be supplied from an external 5 Vdc to 18 Vdc source.

In both cases you need to fit the JP1 power jumper to supply power to the transmitter module.

When powered from the external DC source the LED will illuminate.

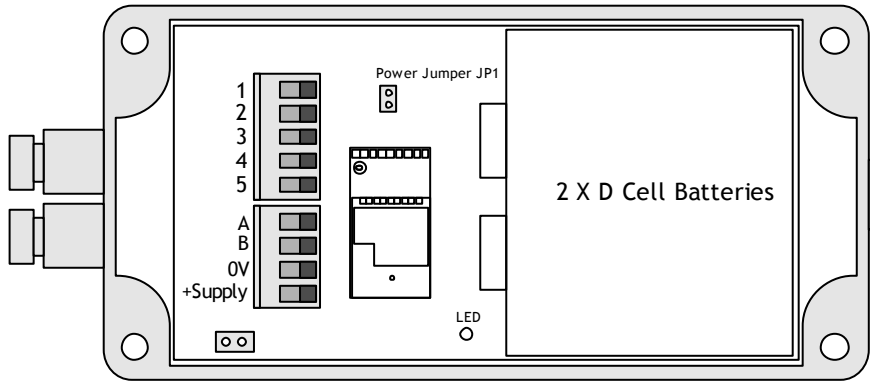

For battery information please refer to [Appendix D – Battery Selection](#)

### Sensor

The current input is connected to the module via a 2 part screw terminal block.

Screw Terminal	Function
1	+5 V Excitation
2	+I
3	-I
4	-Excitation
5	Shield
A	
B	

---

## T24-ACMi-IA

---

### Power

The enclosure is designed to accept two AA batteries. Maximum voltage 1.8 V per cell.

For battery information please refer to [Appendix D – Battery Selection](#)

---

### Sensor

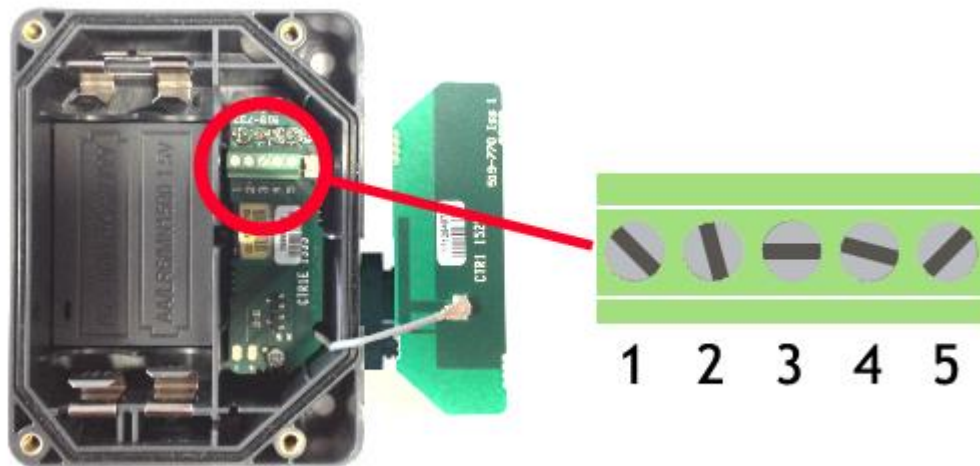

The input connections are accessed by lifting the right hand cover plate, this plate incorporates the T24-ACMi Antenna; take extra care when re-assembling that the grey UHF cable is attached to the antenna socket.

Screw Terminal	Function
1	Shield
2	-Excitation
3	-I in
4	+I in
5	+ 5 V Excitation

---

## T24-ACMm-IA

---

### Power

Power is supplied by connecting a 3V supply to the

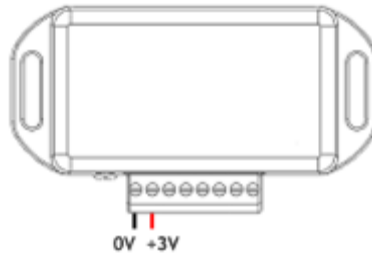

 There is no reverse polarity protection.

---

### Connecting T24-BB1

Power to transmitter modules in this enclosure can also be supplied by a T24-BB1 battery box which contains two AA 1.5 V batteries.

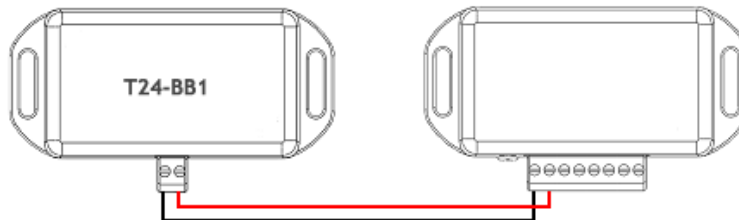

For battery information please refer to [Appendix D – Battery Selection](#)

---

### Sensor

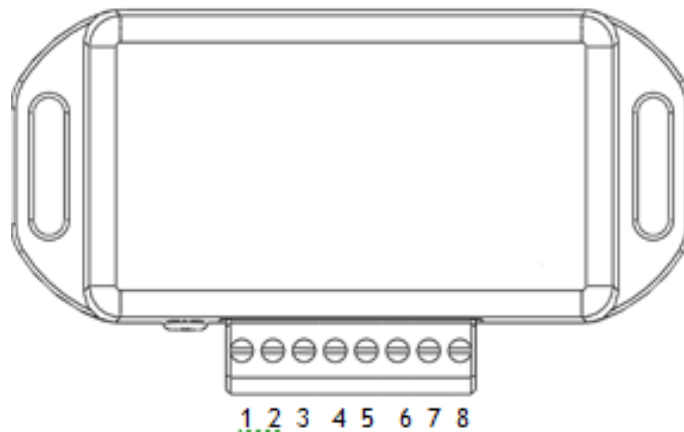

Screw Terminal	Function
5	-Excitation
6	-I in
7	+I in
8	+5 V Excitation

---

---

## Shield Connections (All Enclosures)

We recommend the following rules to determine whether there should be a connection between the transmitter module shield and the sensor chassis or cable:

1. If the sensor is remote to the transmitter module and the screen of the signal cable is **NOT** connected to the sensor chassis then the cable screen should be connected to the transmitter module shield connection.
2. If the sensor is remote to the transmitter module and the screen of the signal cable **IS** connected to the sensor chassis then the cable screen should be **NOT** connected to the transmitter module shield connection.
3. If the transmitter module is integral to the sensor or mounted very close and the module is mounted on a metal chassis then the answer to whether the transmitter module shield connection should be connected to the metal chassis is a matter of experimentation. This connection must be as short as possible. The T24 Toolkit can be used to chart the signal levels and tests should be undertaken to determine whether there is a better radio signal with or without the shield/chassis connection. The quality of the measured reading should also be looked at. In cases where the shield/chassis connection makes no difference to the radio signal or the reading quality then the connection should be made.



## Configuration

The T24 Toolkit provides a means of simple configuration and calibration of the transmitter module along with useful tools to aid integration.

Launch the T24 Toolkit software application and pair to this module to enable the connection to the Toolkit to allow configuration to take place. [See Common Toolkit Pages - Home](#)

## Data Rates and Quality

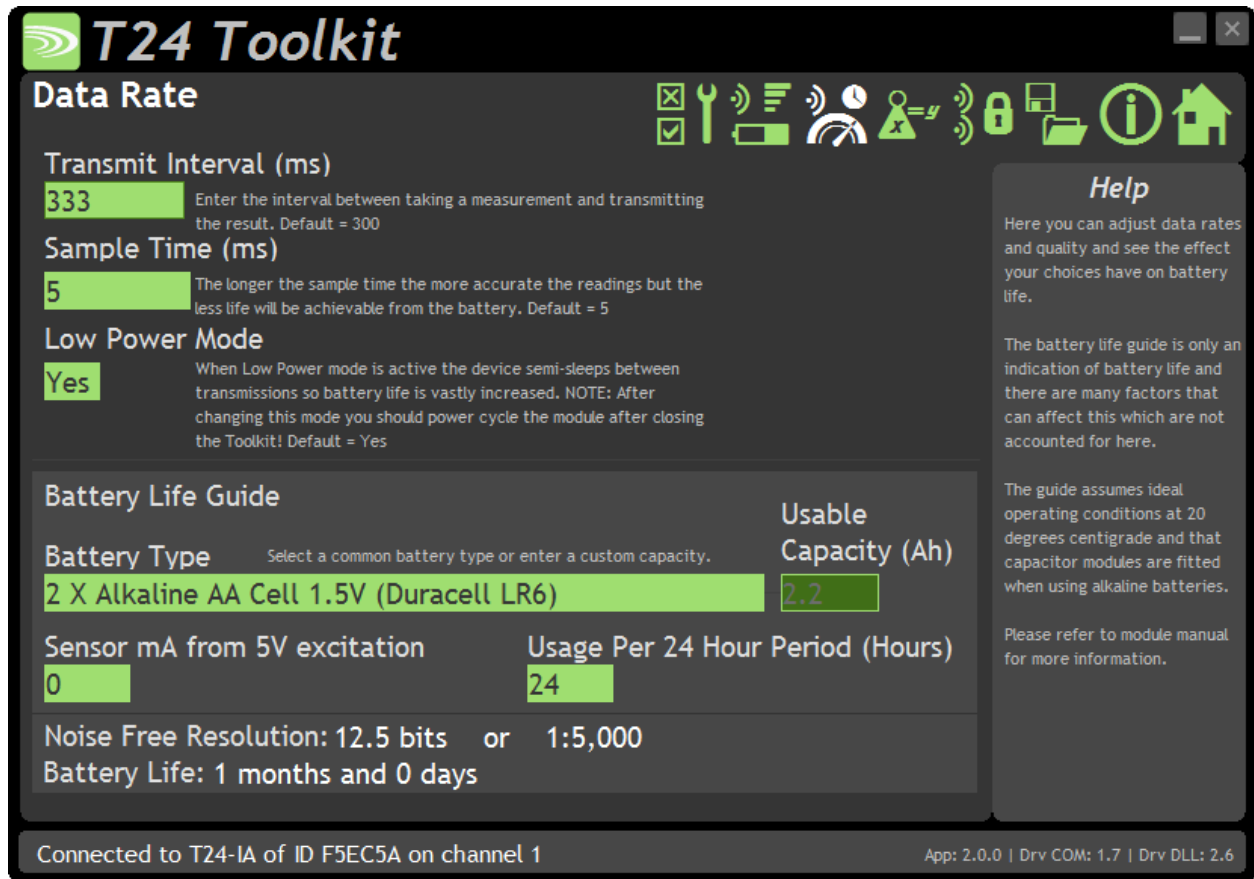

This page allows you to select the rate at which data is transmitted from the transmitter module and the quality. By selecting low power mode and entering some other information the toolkit will also give guides on achievable battery life.

Note that the battery life calculator is assuming the best case scenario which is at 20°C and that the battery has a suitable low internal resistance or that a suitable capacitor is fitted across the battery. See battery details in the Installation section.

### Items you can change:

Transmit Interval

Enter the transmission rate in milliseconds. The default is 300 giving approximately 3 per second which is ideally suited to reading on a handheld. You may want to slow this down to achieve longer battery life.

Sample Time

This is the length of time in milliseconds that the input is sampled before the value is transmitted. This can vary between 5 milliseconds and close to the Transmit Interval. A shorter sample time means that the module is awake for less time so battery life is increased but at the expense of a reading with less noise free resolution. You can vary this to see the effect on battery life and noise free resolution.

Low Power Mode	<p>Unless the transmitter module is non battery powered this should be set to Yes. In between transmissions the transmitter module will enter sleep mode which, for some modules such as the strain gauge transmitter module, will have a massive effect on battery life.</p> <p>A Reason for <b>not</b> using Low Power Mode would be if using the module in a Master-Slave arrangement with PC for example.</p>
Battery Type	<p>This is not a parameter of the module but information used by the battery life guide. You can choose from some preset batteries or choose custom to allow you to select your own battery capacity. See below. This will also offer to change the Battery Low Level if the level suitable for the chosen battery is not the level currently set.</p>
Usable Capacity	<p>This is not a parameter of the module but information used by the battery life guide. This is the capacity of the battery in Amp Hours and has a profound effect on battery life calculations. This capacity needs to be calculated from battery manufacturer's data sheets to take into account that you can only use batteries down to 2.1 volts so in the case of twin AA cells this would be 1.05 volts.</p> <p>Generally the usable capacity will not be as high as that advertised by the battery manufacturer. Temperature and internal resistance of the battery are not taken into account in the guide.</p>
Sensor Resistance	<p>This is only available for certain transmitter modules. This is not a parameter of the module but information used by the battery life guide. Enter the resistance of the connected strain gauge in Ohms.</p>
Usage Per 24 Hour Period	<p>Enter the number of hours per 24 hour period that the T24-HS handheld will be turned on and communicating with a transmitter module.</p>

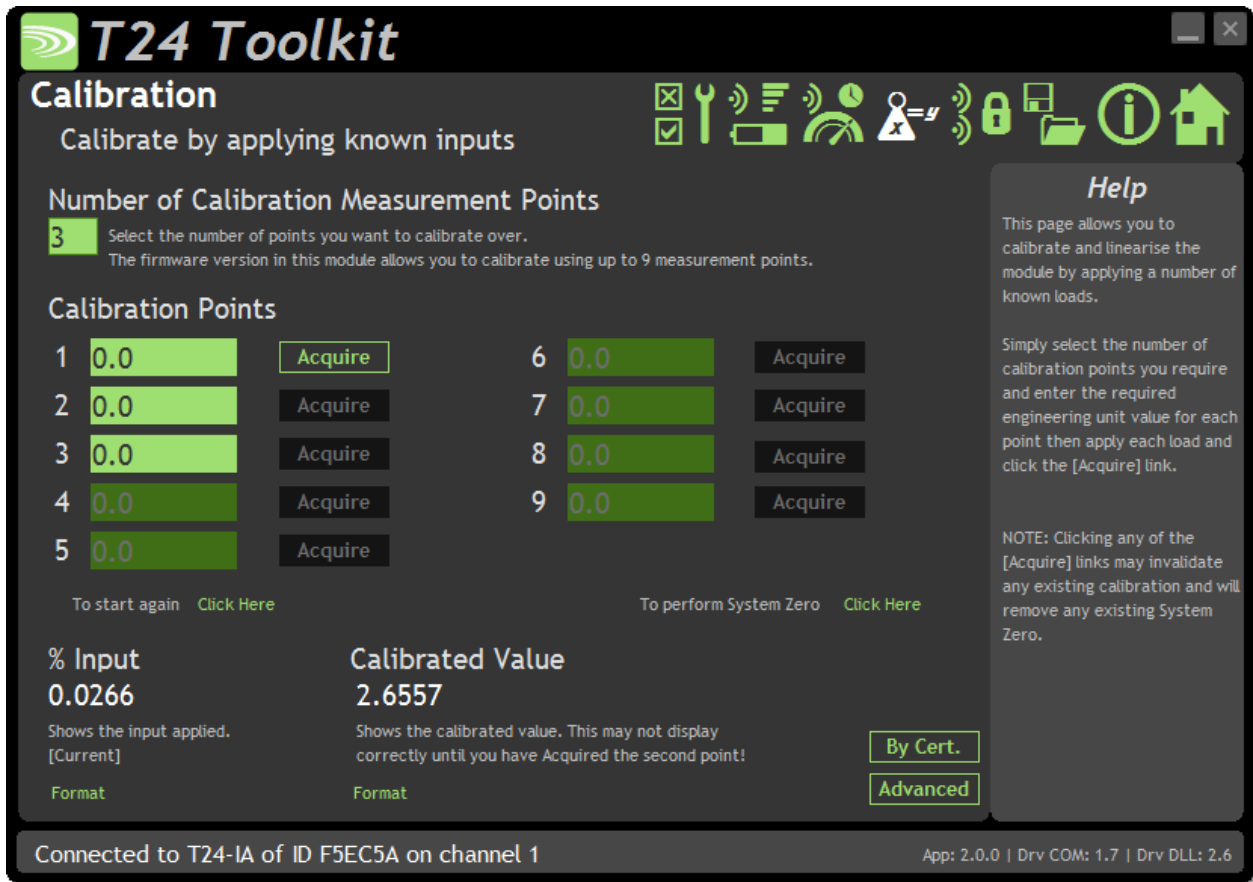

Here you can calibrate the transmitter module and set a system zero if required. This simple page allows semi-automated calibration where you can apply known inputs to calibrate. This calibration includes linearization and is automatically applied. See later for **By Cert** and **Advanced** page where you can adjust individual gains and offsets.

**Calibration Process**

- Decide on how many points you will calibrate over.
- Decide what voltage inputs will be applied (in ascending order) at each point.
- Enter the actual input (in the required units) that you want the module to read at each point.
- Now proceed to apply each input in turn (allowing a settle time) and click the **Acquire** button at that point. You can now apply the next input and click **Acquire** until all the points are completed.

**i** *The voltage input must be ascending through each calibration point.*

The bottom of the page shows the **Input Value** and the **Calibrated Value**. Once the second point has been acquired this **Calibrated Value** should display the actual calibrated value.

**Items you can change:**

Number of Calibration Points    Enter the number of points you wish to calibrate over. In its simplest form you could select two for a linear calibration. For more complex calibrations which include linearization select three to nine points.

Point 1 - 9    For each point enter the engineering unit value that you want the transmitter module to report at the applied input. i.e. 1.67

Acquire 1 - 9	Click this button when the input has been applied and the reading has been allowed to settle. This will acquire the reading and allow you to move to the next points. You will be able to click the button again to re-acquire.
Start Again	Click here to restart the calibration.
System Zero	Once calibrated you may want to remove a fixed system value. In the case of a strain gauge input this may be the weight of a sling, shackle, load bed etc. Apply the required input and click here to set the system zero. The current input will be removed from subsequent readings so that the reading will be zero. To edit this value manually click the <b>Advanced</b> button. System Zero is stored in non-volatile memory in the transmitter module.
By Cert.	You can click the <b>By Cert</b> button to calibrate against a sensor calibration sheet. You just need to enter the input values and associated engineering unit required output value of at least 2 points. This will take you to a different screen.
Advanced	Clicking the advanced button will allow you to edit the gains and offsets for each available calibration point. This will take you to a different screen.

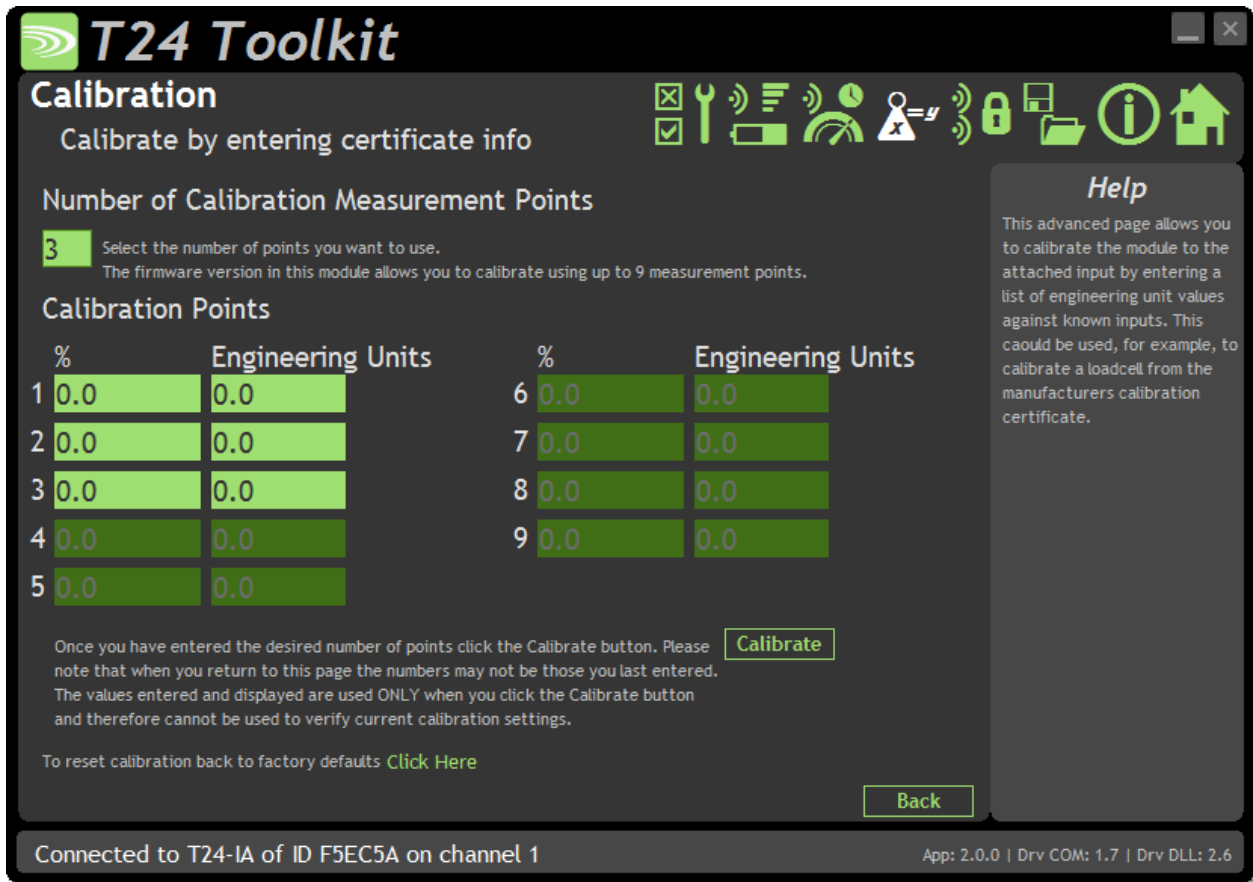

In some circumstances it may not be possible to apply inputs in which case the calibration can be entered manually from a calibration table.

**Items you can change:**

**Number of Calibration Points** Enter the number of points you wish to calibrate over. In its simplest form you could select two for a linear calibration. For more complex calibrations which include linearization select three to nine points.

**Input Points 1 – 9** Enter the % input point for which you will specify a required engineering output value. These modules are factory calibrated where 0% = 0 V and 100% = 10 V

**Engineering Units 1 - 9** Enter the required engineering unit output for the specified input value

**Calibrate** Click this button to calculate and update the module calibration

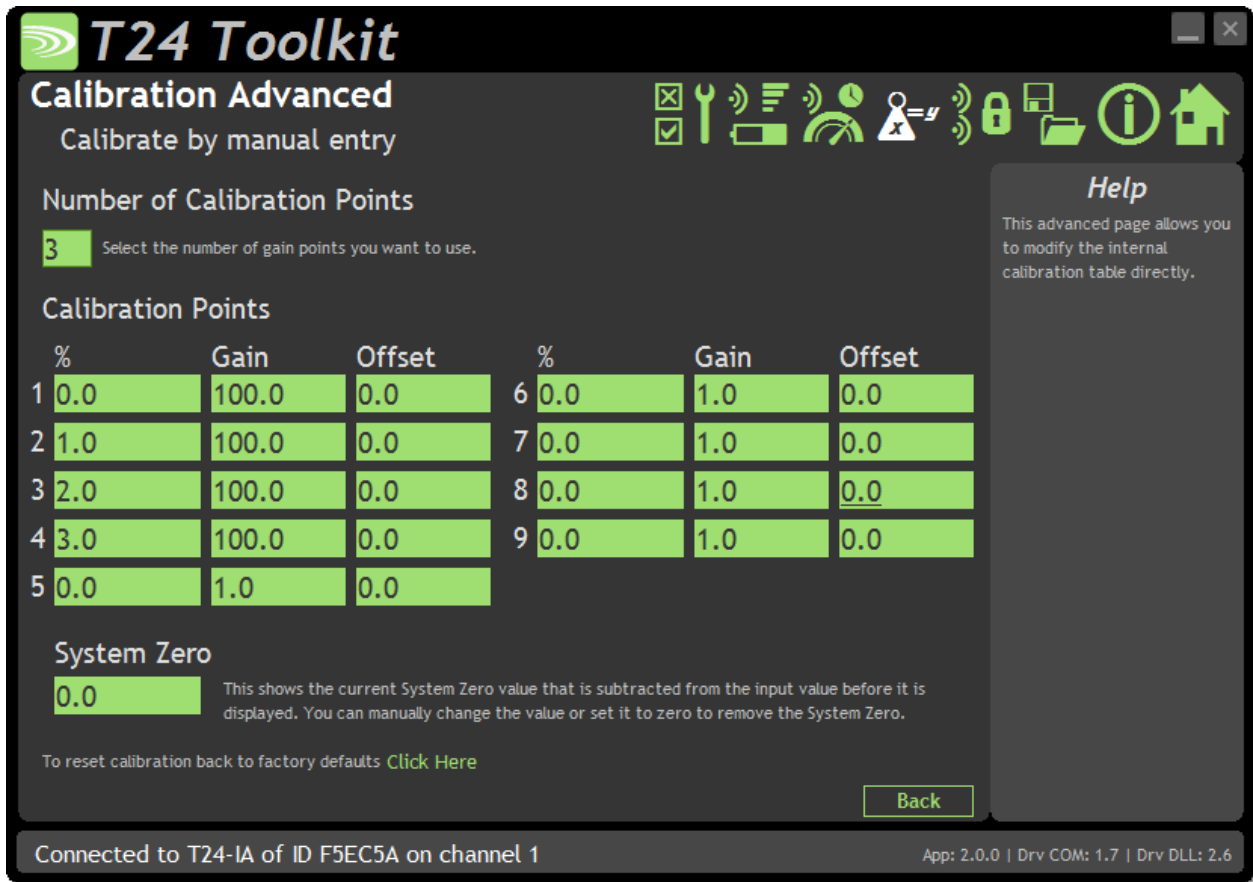

In some circumstances it may not be possible to apply inputs in which case the calibration can be entered manually.

**Items you can change:**

**Number of Calibration Points** Enter the number of points you wish to calibrate over. In its simplest form you could select two for a linear calibration. For more complex calibrations which include linearization select three to nine points.

**Input Points 1 – 9** Enter the % input point to which the associated interpolated gain and offset values will be applied. Note between points the gain and offset values are linearly interpolated. Inputs are extrapolated below point 1 and above point 9.

**Gain 1 - 9** Enter the gain value for associated point

**Offset 1 - 9** Enter the Offset value for associated point

**System Zero** You can set the system zero value here or set it to zero to remove the system zero effect.

**Description of Linearisation Calculations**

The input value is looked up in a table of points which is dependent on what the user has selected, starting from the bottom of the table. When a point is found to which the input is less than then this point and the previous point are used to extrapolate a gain and offset from. This leads to a resultant gain and offset which is applied to the mV/V values as follows.

$$\text{Value} = (\text{input} * \text{Resultant Gain}) - \text{Resultant Offset}.$$

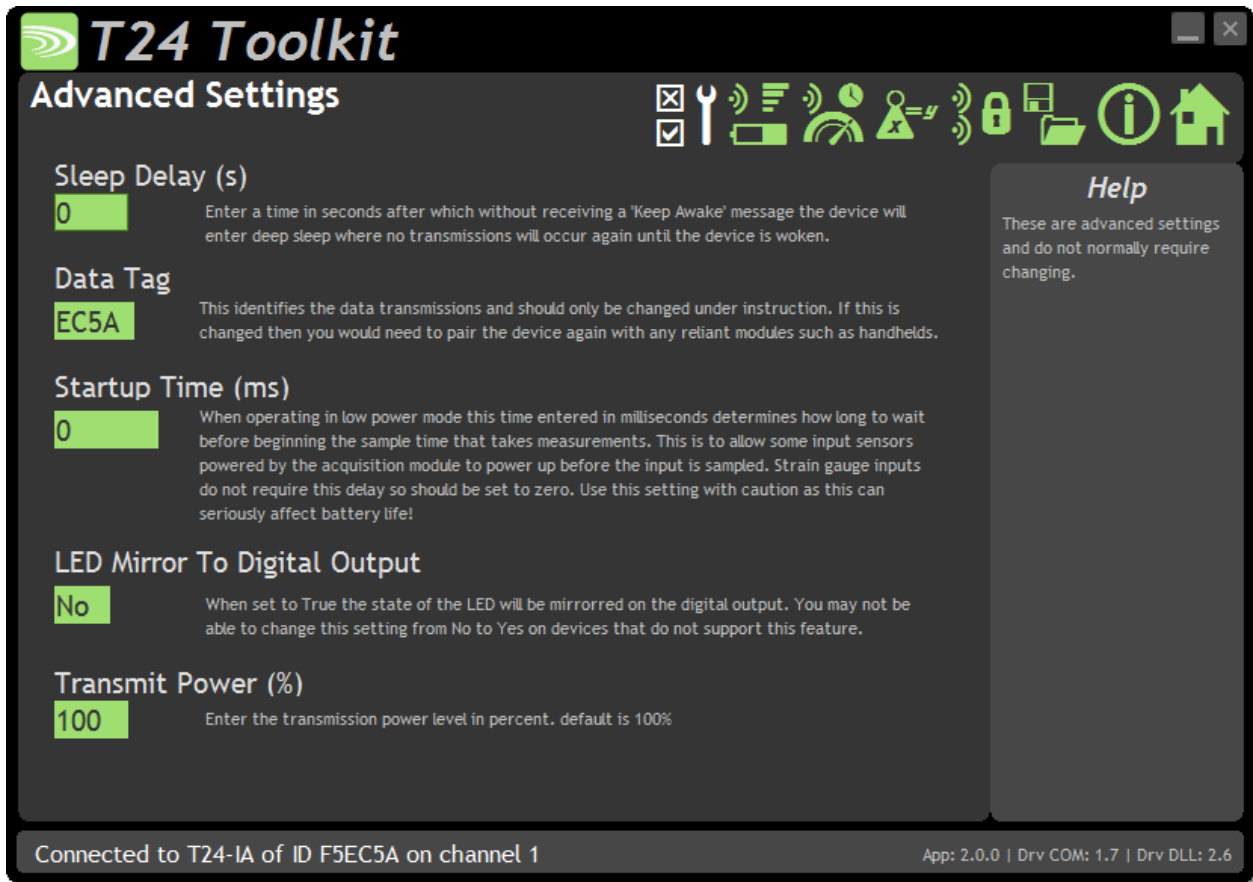

You should not normally need to change these settings.

**Items you can change:**

- Sleep Delay** Here you can enter a delay in seconds after which the transmitter module will return to deep sleep if no Keep Awake message is heard from the T24-HS handheld. The default is 60 seconds.
- Data Tag** The data transmitted by the transmitter module is marked with a Data Tag which is a 2 byte hexadecimal code. By default this is set to the last 2 bytes of the module ID (or to put it another way, the last 4 characters of the module ID). If by some chance you had two transmitter module modules that would be working on the same channel and had the same last 4 characters in their ID (1 in 65,535 chances) you may want to change the data Tag of one of the modules and perform pairing again with the T24-HS handheld.
- Startup Time** Some transmitter modules power a sensor from their excitation voltage. When coupled to a sensor with a slow startup time this setting is used to delay the measurement after wakeup from sleep between readings. This gives the sensor time to settle at the expense of battery life. For strain gauge inputs this settings should be zero.
- LED Mirror to Digital Output** When set to Yes each time the LED is active the digital output is active. This can be useful if the module is to be encapsulated or enclosed and enables a second LED to be externally mounted. This is very useful when using a T24-HR roaming handheld as the transmitter module LED will activate while the handheld is in communications with the module.
- Transmit power** Set the transmit power level from 0 – 100%. Default is 100%

---

## Enclosure & Mounting

This module is available in a number of different enclosure types. Locate your module and follow the link to view dimensional and mounting information for that particular enclosure.

---

### T24-IAe, T24-IAi

These OEM modules are bare PCB modules. Please see [Appendix A – Enclosures & Mounting – OEM Transmitter Modules](#) for more information.

---

### T24-ACM-IA

This module is fitted inside our large enclosure. Please see [Appendix A – Enclosures & Mounting – ACM](#) for more information.

---

### T24-ACMi-IA

This module is fitted inside our medium enclosure. Please see [Appendix A – Enclosures & Mounting – ACMi](#) for more information.

---

### T24-ACMm-IA

This module is fitted inside our small enclosure. Please see [Appendix A – Enclosures & Mounting – ACMm](#) for more information.



---

## Antennas

---

### T24-IAi

This module uses an integrated chip antenna. See [Appendix B – Antennas – Internal Chip Antenna](#)

---

### T24-IAe

Only the T24-IAe module allows for the fitting of external antennas. The choices are:

T24-ANTA	PCB Antenna	See <a href="#">Appendix B – Antennas – T24-ANTA</a>
T24-ANTB	Dipole Antenna	See <a href="#">Appendix B – Antennas – T24-ANTB</a>
T24-ANTC	Dipole Antenna Swivel	See <a href="#">Appendix B – Antennas – T24-ANTC</a>
T24-ANTD	Puck Antenna SMA	See <a href="#">Appendix B – Antennas – T24-ANTD</a>
T24-ANTE	Puck Antenna UFL	See <a href="#">Appendix B – Antennas – T24-ANTE</a>

---

### T24-ACM-IA, T24-ACMi-IA, T24-ACMm-IA

These modules have the antenna already fitted inside the enclosure so there are no specific mounting requirements.

## Specification

Specification at 3V supply at 25°C

Measurement	Min	Typical	Max	Units
Input Range Sensitivity (FR)	0	-	21	mA
Calibrated Range	4		20	mA
Offset Temperature Stability		-	0.5	ppm/°C
Gain Temperature Stability		-	50	ppm/°C
Non Linearity before Linearization		5	25	ppm of FR
Internal Resolution		16,000,000/ 24		Resolution/Bits
Input Impedance	-	47	-	Ω
Input Calibration Accuracy	-	-	0.1	%FR
Noise Free where Sample Time < 10ms		5,000 / 12.5		Resolution/Bits
Noise Free where Sample Time < 100ms		6,000 / 12.75		Resolution/Bits
Noise Free where Sample Time < 1000ms		10,000 / 13.25		Resolution/Bits
Noise Free where Sample Time > 1000ms		30,000 / 14.75		Resolution/Bits

Specification at 3V supply at 25°C

Environmental	Min	Typical	Max	Units
Operating Temperature Range	-20		+55	°C
Storage Temperature	-40		+85	°C
Humidity	0		95	%RH

Power Supply	Min	Typical	Max	Units
Standby / Low Power Mode		5	20	μA
Normal Mode on constantly		40	45	mA
<b>T24-IAe, T24-IAi, T24-ACMi-IA, T24-ACMm-IA</b>				
Power Supply voltage	2.1	3.0	3.6	Vdc
Power Supply ripple			50	mV ac pk-pk
Normal Mode		60	65	mA (1)
<b>T24-ACM-IA</b>				
Power Supply voltage	5		18	Vdc
Power Supply ripple			50	mV ac pk-pk
Normal Mode		60	65	mA (1)

1. Power supply must be capable of supplying 300 mA for 250 μs (Required on start up, waking and during low power operation)

Battery Life in Low Power Mode Generating Results at 3Hz	Usage	Battery Life
Pair AA cells	Constantly on	1 month
Pair AA cells	12 sessions per day of 5 minutes	2 years
Pair D cells	Constantly on	4.5 months
Pair D cells	12 sessions per day of 5 minutes	> 9 years

## Radio Range

To determine radio range please refer to [Appendix B – Antenna Range](#)

---

## T24-ACM-TA, T24-ACMi-TA, T24-ACMm-TA, T24-TAe, T24-TAi

---

### Overview

The T24-TA temperature sensor transmitter is a high performance module designed for the collection and processing of temperature measurements. The wireless sensor transmitter requires an external platinum temperature sensor (Pt100 type 385).

---

### Order Codes

---

#### T24-TAe



Temperature transmitter module with external antenna UFL connector.

#### T24-TAi



Temperature transmitter module with integral antenna.

---

#### T24-ACM-TA



Temperature transmitter module mounted in large weatherproof enclosure with battery holder for two D cell alkaline batteries. Also has ability to be powered from external supply voltage.

#### T24-ACMi-TA



Temperature transmitter module mounted in medium weatherproof enclosure with battery holder for two AA batteries.

---

#### T24-ACMm-TA



Temperature transmitter module mounted in small enclosure with screw terminals to connect external 3 V power supply.

---

## Connections

### T24-TAe, T24-TAi

#### Power

Attach power supply wiring to the module as shown below:

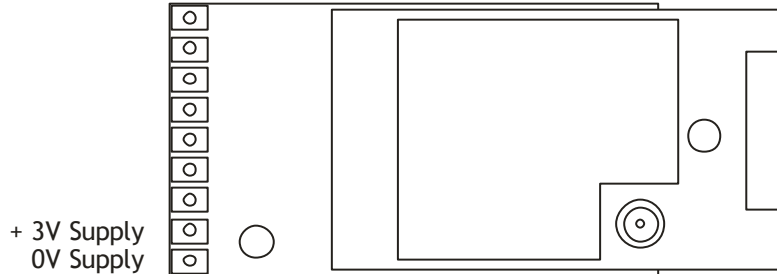

Connect to a 3 Volt power supply or batteries.

**!** This module is **not** reverse polarity protected!  
The maximum voltage is 3.6 V!

For battery information please refer to [Appendix D – Battery Selection](#)

#### Sensor

Voltage input connected as follows:

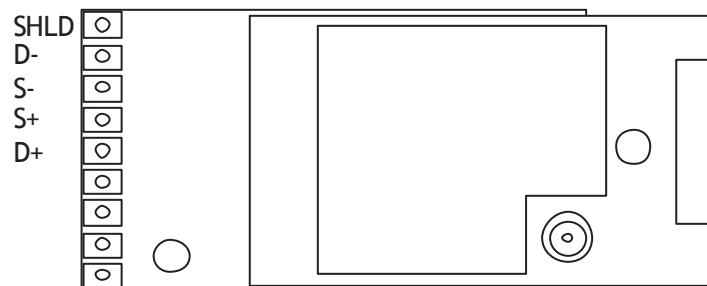

The Pt100 probe can be connected in 2, 3 or 4 wire measurement configurations.

#### 2 Wire

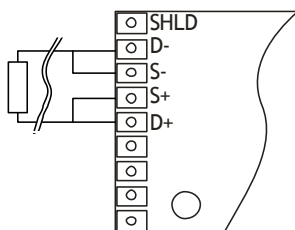

The simplest resistance thermometer configuration uses two wires. It is only used when high accuracy is not required, as the resistance of the connecting wires is added to that of the sensor, leading to errors of measurement. This configuration allows use of 100 meters of cable.

#### 3 Wire

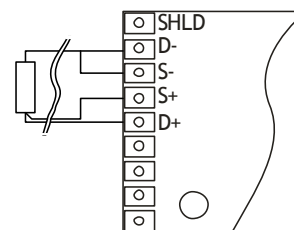

In order to minimize the effects of the lead resistances, a three-wire configuration can be used. Using this method the two leads to the sensor are on adjoining arms. There is a lead resistance in each arm of the bridge so that the resistance is cancelled out, so long as the two lead resistances are accurately the same. This configuration allows up to 600 meters of cable.

## 4 Wire

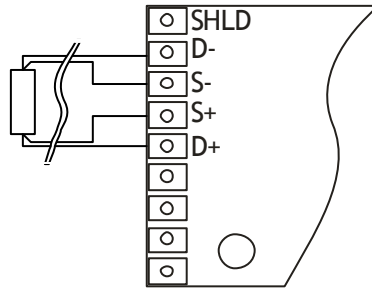

The four-wire resistance thermometer configuration increases the accuracy and reliability of the resistance being measured: the resistance error due to lead wire resistance is zero. In the diagram above a standard two-terminal RTD is used with another pair of wires to form an additional loop that cancels out the lead resistance. It provides full cancellation of spurious effects; cable resistance of up to 15 ohms can be handled.

## T24-ACM-TA

### Power

Power can be supplied by fitting two D cell alkaline 1.5 V batteries or the module can be supplied from an external 5 Vdc to 18 Vdc source.

In both cases you need to fit the JP1 power jumper to supply power to the transmitter module.

When powered from the external DC source the LED will illuminate.

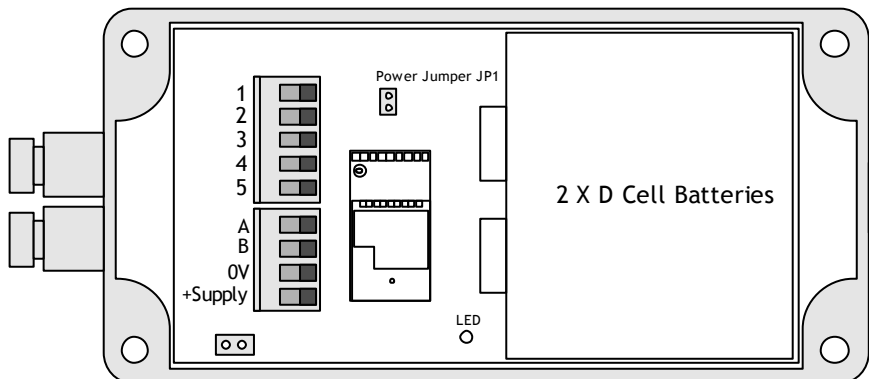

For battery information please refer to [Appendix D – Battery Selection](#)

### Sensor

The temperature sensor input is connected to the module via a 2 part screw terminal block.

Screw Terminal	Function
1	+Drive
2	+Sense
3	-Sense
4	-Drive
5	Shield
A	
B	

---

## T24-ACMi-TA

---

### Power

The enclosure is designed to accept two AA batteries. Maximum voltage 1.8 V per cell.

For battery information please refer to [Appendix D – Battery Selection](#)

---

### Sensor

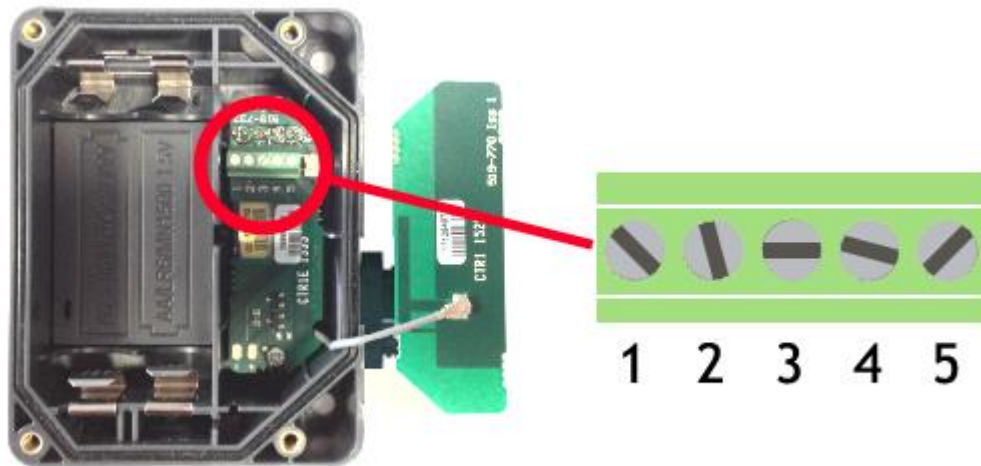

The input connections are accessed by lifting the right hand cover plate, this plate incorporates the T24-ACMi Antenna; take extra care when re-assembling that the grey UHF cable is attached to the antenna socket.

Screw Terminal	Function
1	Shield
2	-Drive
3	-Sense
4	+Sense
5	+Drive

---

---

## T24-ACMm-TA

---

### Power

Power is supplied by connecting a 3 V supply to the

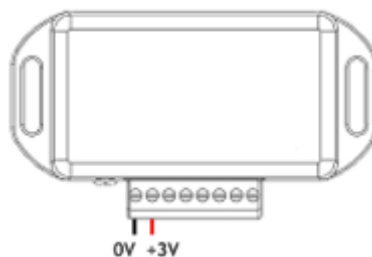

! There is no reverse polarity protection.

### Connecting T24-BB1

Power to transmitter modules in this enclosure can also be supplied by a T24-BB1 battery box which contains two AA 1.5 V batteries.

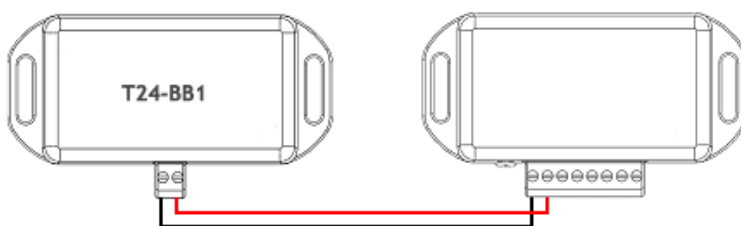

For battery information please refer to [Appendix D – Battery Selection](#)

### Sensor

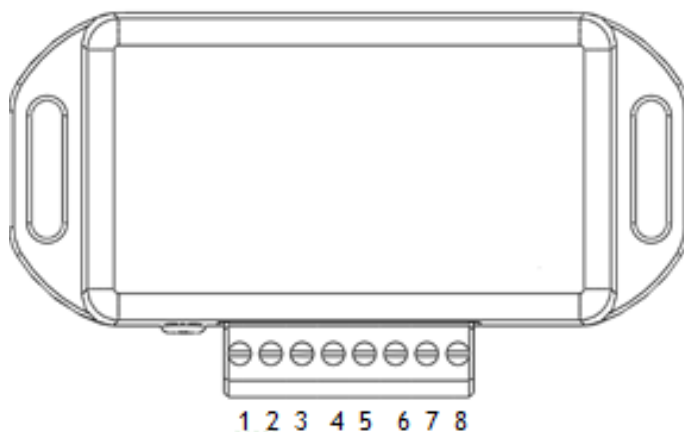

Screw Terminal	Function
5	-Drive
6	-Sense
7	+Sense
8	+Drive

---

## Shield Connections (All Enclosures)

We recommend the following rules to determine whether there should be a connection between the transmitter module shield and the sensor chassis or cable:

1. If the sensor is remote to the transmitter module and the screen of the signal cable is **NOT** connected to the sensor chassis then the cable screen should be connected to the transmitter module shield connection.
2. If the sensor is remote to the transmitter module and the screen of the signal cable **IS** connected to the sensor chassis then the cable screen should be **NOT** connected to the transmitter module shield connection.
3. If the transmitter module is integral to the sensor or mounted very close and the module is mounted on a metal chassis then the answer to whether the transmitter module shield connection should be connected to the metal chassis is a matter of experimentation. This connection must be as short as possible. The T24 Toolkit can be used to chart the signal levels and tests should be undertaken to determine whether there is a better radio signal with or without the shield/chassis connection. The quality of the measured reading should also be looked at. In cases where the shield/chassis connection makes no difference to the radio signal or the reading quality then the connection should be made.



## Configuration

The T24 Toolkit provides a means of simple configuration and calibration of the transmitter module along with useful tools to aid integration.

Launch the T24 Toolkit software application and pair to this module to enable the connection to the Toolkit to allow configuration to take place. [See Common Toolkit Pages - Home](#)

## Data Rates and Quality

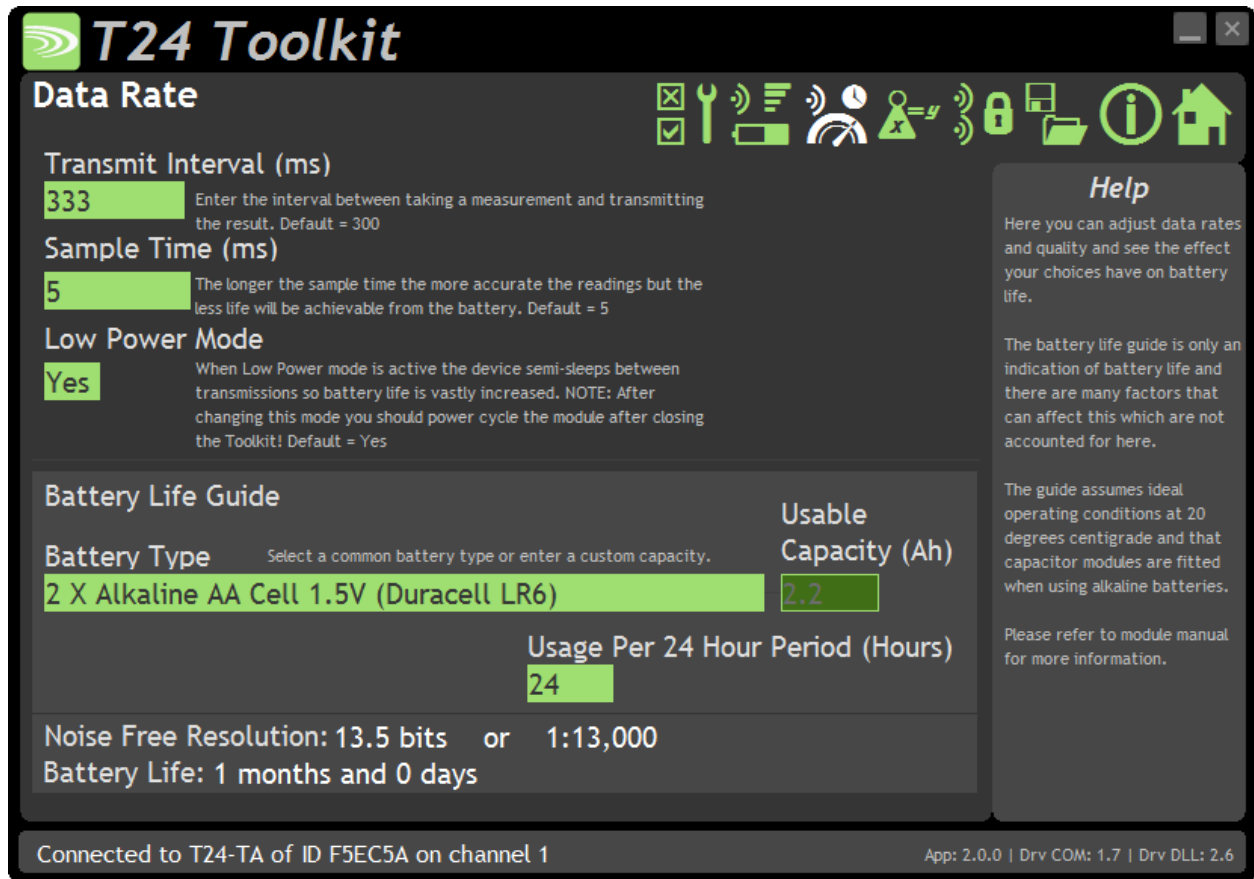

This page allows you to select the rate at which data is transmitted from the transmitter module and the quality. By selecting low power mode and entering some other information the toolkit will also give guides on achievable battery life.

Note that the battery life calculator is assuming the best case scenario which is at 20°C and that the battery has a suitable low internal resistance or that a suitable capacitor is fitted across the battery. See battery details in the Installation section.

### Items you can change:

Transmit Interval

Enter the transmission rate in milliseconds. The default is 300 giving approximately 3 per second which is ideally suited to reading on a handheld. You may want to slow this down to achieve longer battery life.

Sample Time

This is the length of time in milliseconds that the input is sampled before the value is transmitted. This can vary between 5 milliseconds and close to the Transmit Interval. A shorter sample time means that the module is awake for less time so battery life is increased but at the expense of a reading with less noise free resolution. You can vary this to see the effect on battery life and noise free resolution.

Low Power Mode	<p>Unless the transmitter module is non battery powered this should be set to Yes. In between transmissions the transmitter module will enter sleep mode which, for some modules such as the strain gauge transmitter module, will have a massive effect on battery life.</p> <p>A Reason for <b>not</b> using Low Power Mode would be if using the module in a Master-Slave arrangement with PC for example.</p>
Battery Type	<p>This is not a parameter of the module but information used by the battery life guide. You can choose from some preset batteries or choose custom to allow you to select your own battery capacity. See below. This will also offer to change the Battery Low Level if the level suitable for the chosen battery is not the level currently set.</p>
Usable Capacity	<p>This is not a parameter of the module but information used by the battery life guide. This is the capacity of the battery in Amp Hours and has a profound effect on battery life calculations. This capacity needs to be calculated from battery manufacturer's data sheets to take into account that you can only use batteries down to 2.1 volts so in the case of twin AA cells this would be 1.05 volts.</p> <p>Generally the usable capacity will not be as high as that advertised by the battery manufacturer. Temperature and internal resistance of the battery are not taken into account in the guide.</p>
Sensor Resistance	<p>This is only available for certain transmitter modules. This is not a parameter of the module but information used by the battery life guide. Enter the resistance of the connected strain gauge in Ohms.</p>
Usage Per 24 Hour Period	<p>Enter the number of hours per 24 hour period that the T24-HS handheld will be turned on and communicating with a transmitter module.</p>

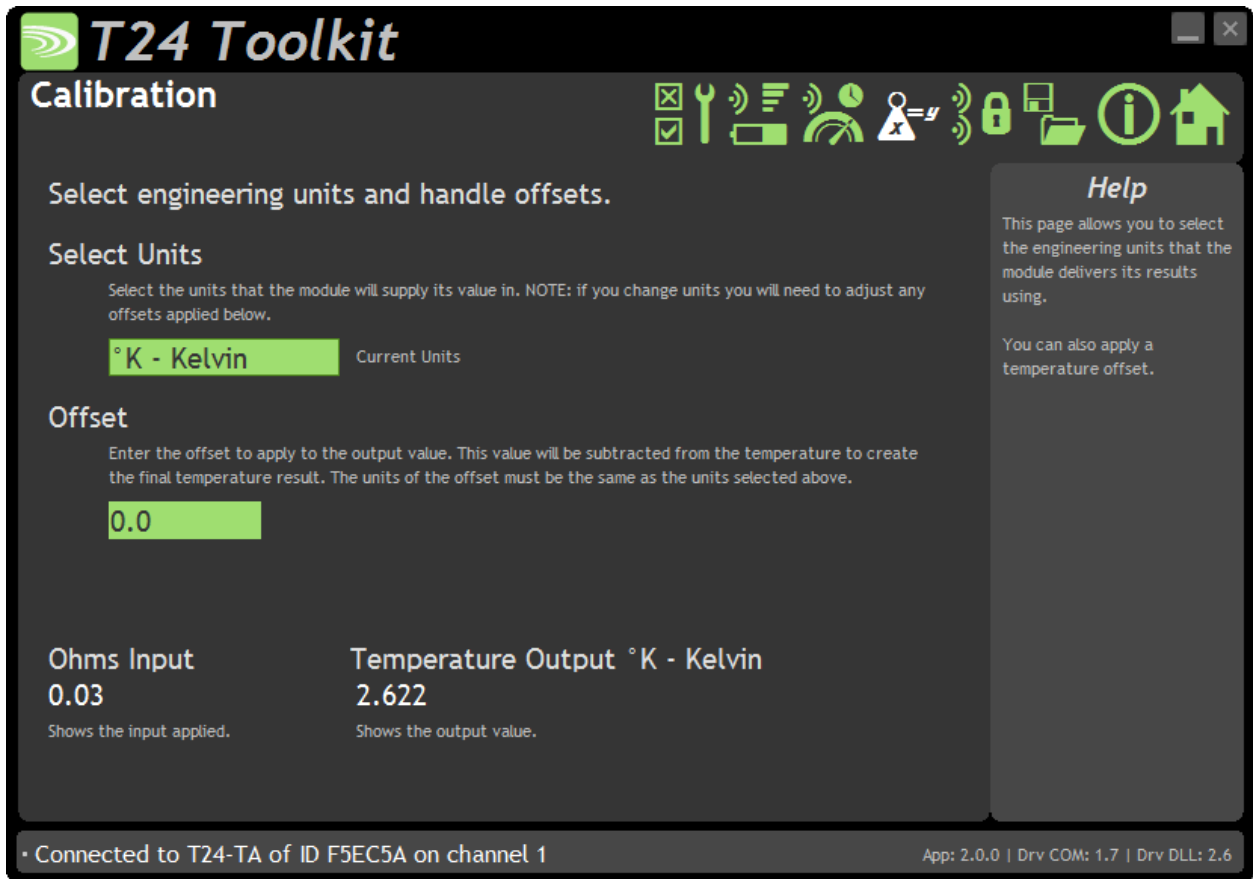

This module does not provide calibration, as such, because it is factory calibrated. However, on this page you can select the units and set an offset if required.

The bottom of the page shows the **Input** resistance and the **Temperature Output**.

**Items you can change:**

Select Units

Simply select the required temperature units from the drop down list. If you change units you will have to adjust any entered offsets below.

Offset

This allows you to compensate for resistances in the sensor cable or to just generally apply an offset to the output. The value you enter here will be subtracted from the measured temperature to create the transmitted temperature. The offset is entered in the same engineering units as selected above.

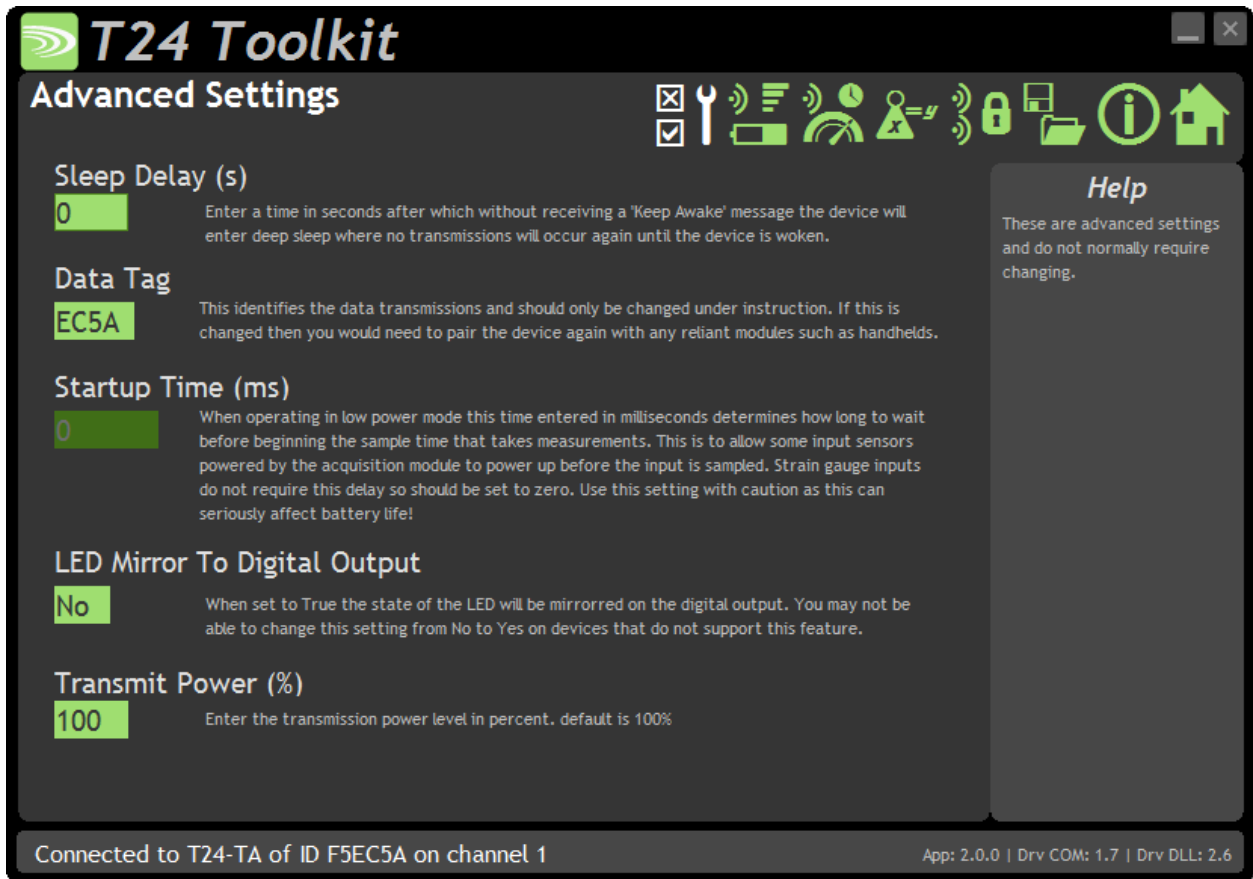

You should not normally need to change these settings.

**Items you can change:**

- Sleep Delay                      Here you can enter a delay in seconds after which the transmitter module will return to deep sleep if no Keep Awake message is heard from the T24-HS handheld. The default is 60 seconds.
  
- Data Tag                              The data transmitted by the transmitter module is marked with a Data Tag which is a 2 byte hexadecimal code. By default this is set to the last 2 bytes of the module ID (or to put it another way, the last 4 characters of the module ID). If by some chance you had two transmitter module modules that would be working on the same channel and had the same last 4 characters in their ID (1 in 65,535 chances) you may want to change the data Tag of one of the modules and perform pairing again with the T24-HS handheld.
  
- Startup Time                         Not applicable to this module.
  
- LED Mirror to Digital Output      When set to Yes each time the LED is active the digital output is active. This can be useful if the module is to be encapsulated or enclosed and enables a second LED to be externally mounted. This is very useful when using a T24-HR roaming handheld as the transmitter module LED will activate while the handheld is in communications with the module.
  
- Transmit power                      Set the transmit power level from 0 – 100%. Default is 100%

---

## Enclosure & Mounting

This module is available in a number of different enclosure types. Locate your module and follow the link to view dimensional and mounting information for that particular enclosure.

---

### T24-TAe, T24-TAi

These OEM modules are bare PCB modules. Please see [Appendix A – Enclosures & Mounting – OEM Transmitter Modules](#) for more information.

---

### T24-ACM-TA

This module is fitted inside our large enclosure. Please see [Appendix A – Enclosures & Mounting – ACM](#) for more information.

---

### T24-ACMi-TA

This module is fitted inside our medium enclosure. Please see [Appendix A – Enclosures & Mounting – ACMi](#) for more information.

---

### T24-ACMm-TA

This module is fitted inside our small enclosure. Please see [Appendix A – Enclosures & Mounting – ACMm](#) for more information.

---

## Antennas

---

### T24-TAi

This module uses an integrated chip antenna. See [Appendix B – Antennas – Internal Chip Antenna](#)

---

### T24-TAe

Only the T24-TAe module allows for the fitting of external antennas. The choices are:

T24-ANTA	PCB Antenna	See <a href="#">Appendix B – Antennas – T24-ANTA</a>
T24-ANTB	Dipole Antenna	See <a href="#">Appendix B – Antennas – T24-ANTB</a>
T24-ANTC	Dipole Antenna Swivel	See <a href="#">Appendix B – Antennas – T24-ANTC</a>
T24-ANTD	Puck Antenna SMA	See <a href="#">Appendix B – Antennas – T24-ANTD</a>
T24-ANTE	Puck Antenna UFL	See <a href="#">Appendix B – Antennas – T24-ANTE</a>

---

### T24-ACM-TA, T24-ACMi-TA, T24-ACMm-TA

These modules have the antenna already fitted inside the enclosure so there are no specific mounting requirements.

## Specification

Specification at 3V supply at 25°C

Measurement	Min	Typical	Max	Units
Temperature Range	-200		500	°C
Accuracy (-20 to +40 °C)		0.1	0.2	°C
Accuracy (-40 to +85 °C)		0.2	0.35	°C
Internal Resolution		16,000,000/ 24		Resolution/bits
Noise Free where Sample Time < 5ms		13,000 / 13.5		Resolution/bits
Noise Free where Sample Time < 10ms		17,000 / 14		Resolution/bits
Noise Free where Sample Time < 100ms		62,000 / 16		Resolution/bits
Noise Free where Sample Time > 1000ms		158,000 / 17		Resolution/bits

Environmental	Min	Typical	Max	Units
Operating Temperature Range	-20		+55	°C
Storage Temperature	-40		+85	°C
Humidity	0		95	%RH

Power Supply	Min	Typical	Max	Units
Standby / Low Power Mode		5	20	µA
Normal Mode on constantly		55	60	mA
<b>T24-TAe, T24-TAi, T24-ACMi-TA, T24-ACMm-TA</b>				
Power Supply voltage	2.1	3.0	3.6	Vdc
Power Supply ripple			50	mV ac pk-pk
Normal Mode (1K Bridge)		60	65	mA (1)
<b>T24-ACM-TA</b>				
Power Supply voltage	5		18	Vdc
Power Supply ripple			50	mV ac pk-pk
Normal Mode (1K Bridge)		60	65	mA (1)

1. Power supply must be capable of supplying 300 mA for 250 µs (Required on start up, waking and during low power operation)

Battery Life in Low Power Mode Generating Results at 3Hz	Usage	Battery Life
Pair AA cells	Constantly on	1 month
Pair AA cells	12 sessions per day of 5 minutes	2 years
Pair D cells	Constantly on	4.5 months
Pair D cells	12 sessions per day of 5 minutes	> 9 years

## Radio Range

To determine radio range please refer to [Appendix B – Antenna Range](#)

---

## T24-ACM-RA, T24-ACMi-RA, T24-ACMm-RA, T24-RAe, T24RAi

---

### Overview

The T24-RA is a remote transmitter module for the collection and processing of potentiometer resistance measurements. The module measures the resistance and periodically transmits it. Between transmissions the module is optionally in a power saving sleep mode to conserve batteries

---

### Order Codes

---

#### T24-RAe



Resistance transmitter module with external antenna UFL connector.

#### T24-RAi



Resistance transmitter module with integral antenna.

---

#### T24-ACM-RA



Resistance transmitter module mounted in large weatherproof enclosure with battery holder for two D cell alkaline batteries. Also has ability to be powered from external supply voltage.

#### T24-ACMi-RA



Resistance transmitter module mounted in medium weatherproof enclosure with battery holder for two AA batteries.

---

#### T24-ACMm-RA



Resistance transmitter module mounted in small enclosure with screw terminals to connect external 3 V power supply.

---

---

## Connections

---

### T24-RAe, T24-RAi

---

#### Power

Attach power supply wiring to the module as shown below:

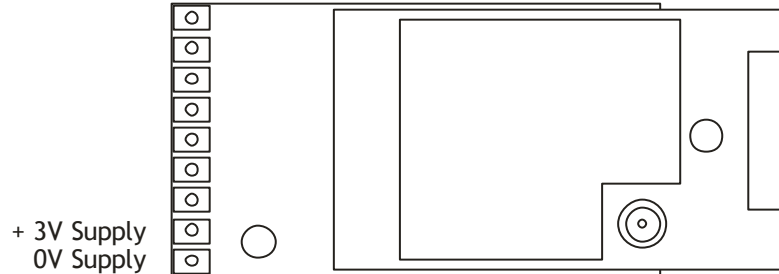

Connect to a 3 volt power supply or batteries.



This module is **not** reverse polarity protected!  
The maximum voltage is 3.6 V!

For battery information please refer to [Appendix D – Battery Selection](#)

---

#### Sensor

Voltage input connected as follows:

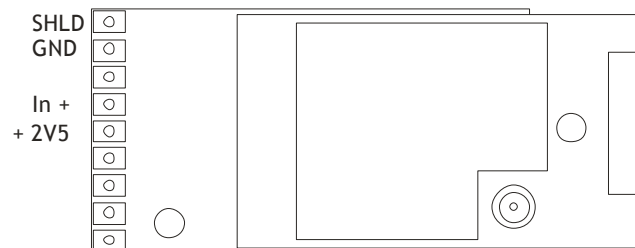

Basic configuration with potentiometer shown below:

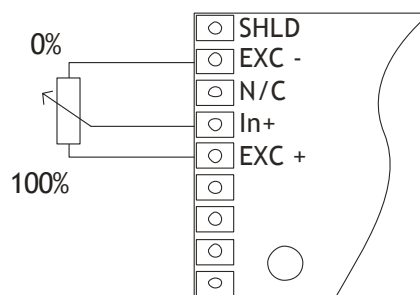

---

### T24-ACM-RA

---

#### Power

Power can be supplied by fitting two D cell alkaline 1.5 V batteries or the module can be supplied from an external 5 Vdc to 18 Vdc source.

In both cases you need to fit the JP1 power jumper to supply power to the transmitter module.

When powered from the external DC source the LED will illuminate.



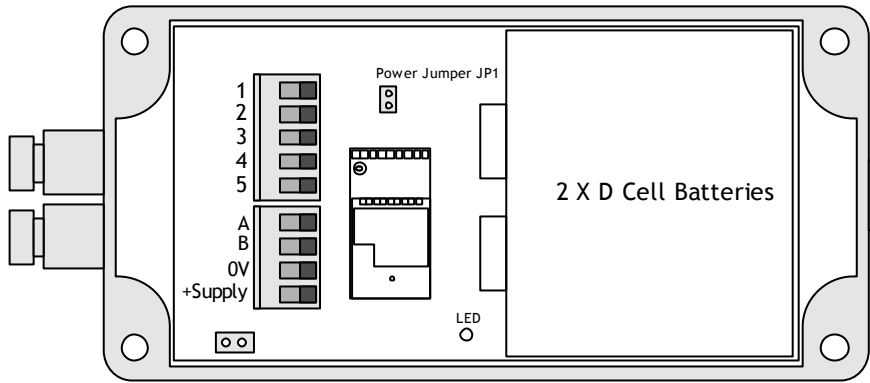

For battery information please refer to [Appendix D – Battery Selection](#)

### Sensor

The resistance input is connected to the module via a 2 part screw terminal block.

Screw Terminal	Function
1	+2V5 Excitation
2	+Input
3	Not Connected
4	-Excitation
5	Shield
A	
B	

---

## T24-ACMi-RA

---

### Power

The enclosure is designed to accept two AA batteries. Maximum voltage 1.8 V per cell.

For battery information please refer to [Appendix D – Battery Selection](#)

---

### Sensor

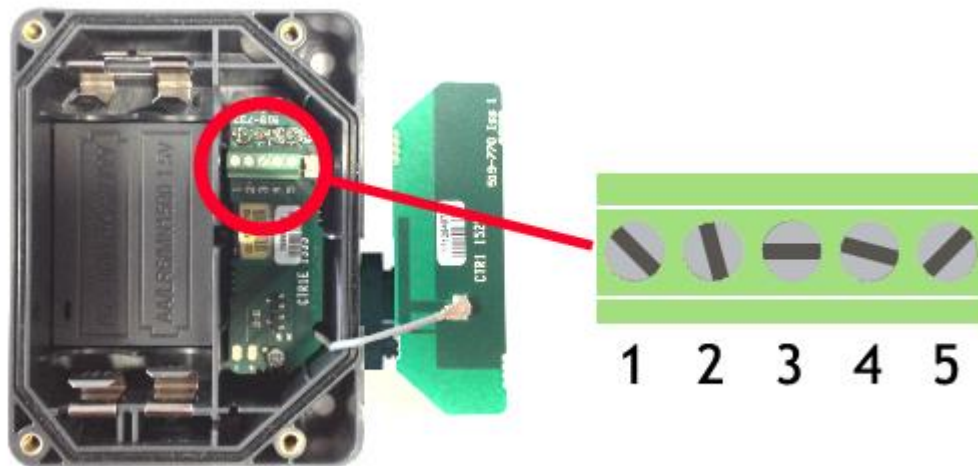

The input connections are accessed by lifting the right hand cover plate, this plate incorporates the T24-ACMi Antenna; take extra care when re-assembling that the grey UHF cable is attached to the antenna socket.

Screw Terminal	Function
1	Shield
2	-Excitation
3	Not Connected
4	+ Input
5	+2V5 Excitation

---

## T24-ACMm-RA

---

### Power

Power is supplied by connecting a 3 V supply to the

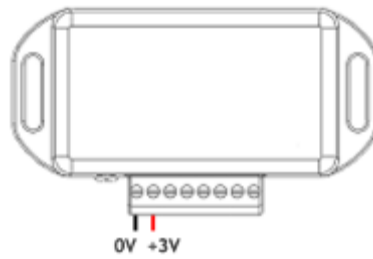

**!** There is no reverse polarity protection.

---

### Connecting T24-BB1

Power to transmitter modules in this enclosure can also be supplied by a T24-BB1 battery box which contains two AA 1.5 V batteries.

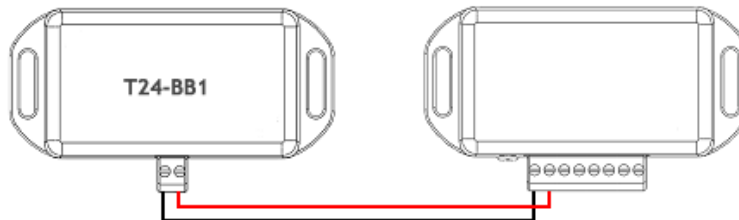

For battery information please refer to [Appendix D – Battery Selection](#)

---

### Sensor

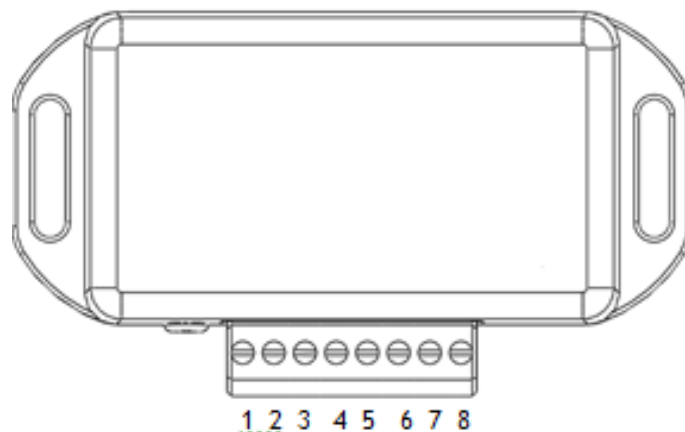

Screw Terminal	Function
5	-Excitation
6	Not Connected
7	+Input
8	+2V5 Excitation

---

---

## Shield Connections (All Enclosures)

We recommend the following rules to determine whether there should be a connection between the transmitter module shield and the sensor chassis or cable:

1. If the sensor is remote to the transmitter module and the screen of the signal cable is **NOT** connected to the sensor chassis then the cable screen should be connected to the transmitter module shield connection.
2. If the sensor is remote to the transmitter module and the screen of the signal cable **IS** connected to the sensor chassis then the cable screen should be **NOT** connected to the transmitter module shield connection.
3. If the transmitter module is integral to the sensor or mounted very close and the module is mounted on a metal chassis then the answer to whether the transmitter module shield connection should be connected to the metal chassis is a matter of experimentation. This connection must be as short as possible. The T24 Toolkit can be used to chart the signal levels and tests should be undertaken to determine whether there is a better radio signal with or without the shield/chassis connection. The quality of the measured reading should also be looked at. In cases where the shield/chassis connection makes no difference to the radio signal or the reading quality then the connection should be made.

## Configuration

The T24 Toolkit provides a means of simple configuration and calibration of the transmitter module along with useful tools to aid integration.

Launch the T24 Toolkit software application and pair to this module to enable the connection to the Toolkit to allow configuration to take place. [See Common Toolkit Pages - Home](#)

## Data Rates and Quality

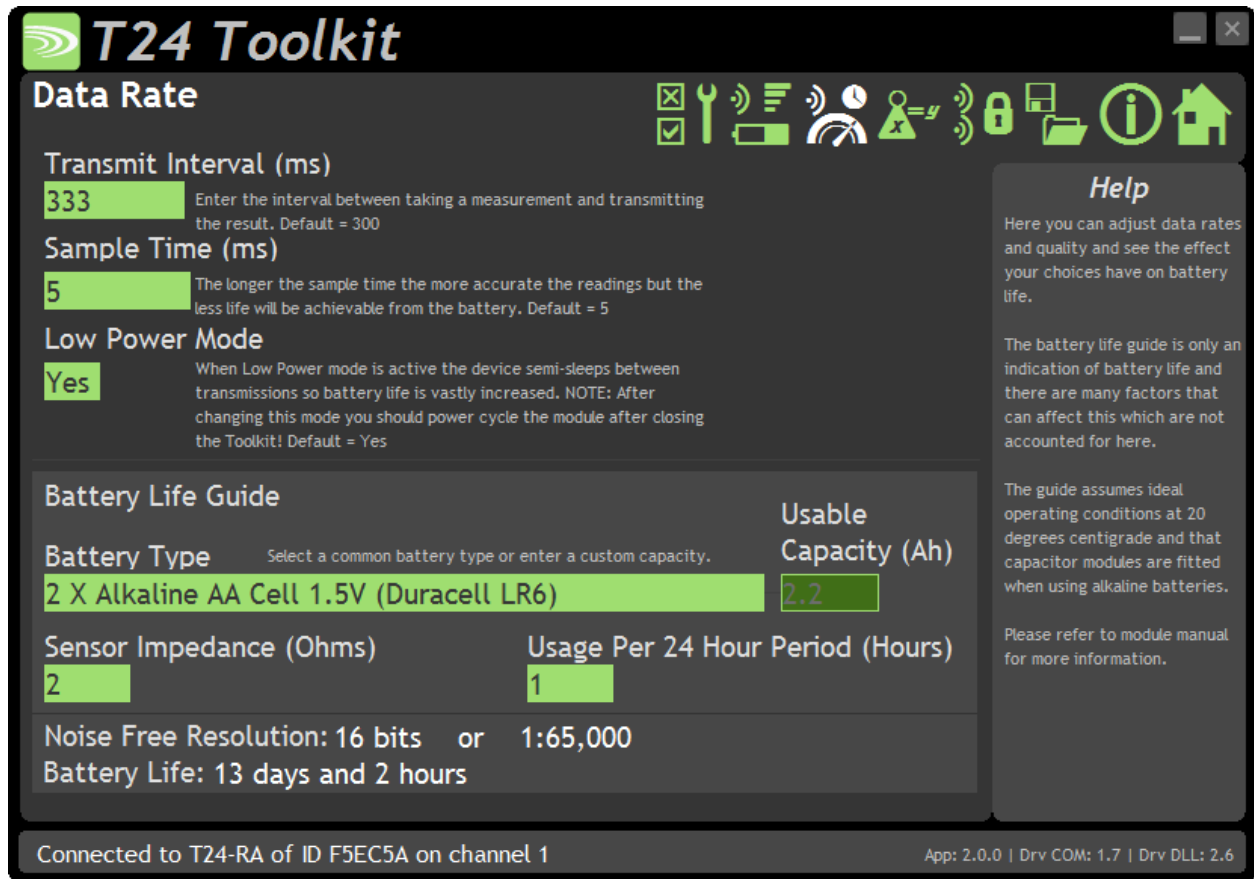

This page allows you to select the rate at which data is transmitted from the transmitter module and the quality. By selecting low power mode and entering some other information the toolkit will also give guides on achievable battery life.

Note that the battery life calculator is assuming the best case scenario which is at 20°C and that the battery has a suitable low internal resistance or that a suitable capacitor is fitted across the battery. See battery details in the Installation section.

### Items you can change:

Transmit Interval

Enter the transmission rate in milliseconds. The default is 300 giving approximately 3 per second which is ideally suited to reading on a handheld. You may want to slow this down to achieve longer battery life.

Sample Time

This is the length of time in milliseconds that the input is sampled before the value is transmitted. This can vary between 5 milliseconds and close to the Transmit Interval. A shorter sample time means that the module is awake for less time so battery life is increased but at the expense of a reading with less noise free resolution. You can vary this to see the effect on battery.

Low Power Mode	<p>Unless the transmitter module is non battery powered this should be set to Yes. In between transmissions the transmitter module will enter sleep mode which, for some modules such as the strain gauge transmitter module, will have a massive effect on battery life.</p> <p>A Reason for <b>not</b> using Low Power Mode would be if using the module in a Master-Slave arrangement with PC for example.</p>
Battery Type	<p>This is not a parameter of the module but information used by the battery life guide. You can choose from some preset batteries or choose custom to allow you to select your own battery capacity. See below. This will also offer to change the Battery Low Level if the level suitable for the chosen battery is not the level currently set.</p>
Usable Capacity	<p>This is not a parameter of the module but information used by the battery life guide. This is the capacity of the battery in Amp Hours and has a profound effect on battery life calculations. This capacity needs to be calculated from battery manufacturer's data sheets to take into account that you can only use batteries down to 2.1 volts so in the case of twin AA cells this would be 1.05 volts.</p> <p>Generally the usable capacity will not be as high as that advertised by the battery manufacturer. Temperature and internal resistance of the battery are not taken into account in the guide.</p>
Sensor Impedance Ohms	<p>Although the Impedance will vary an estimate of the average sensor impedance will provide a good indication of battery life.</p>
Usage Per 24 Hour Period	<p>Enter the number of hours per 24 hour period that the T24-HS handheld will be turned on and communicating with a transmitter module.</p>

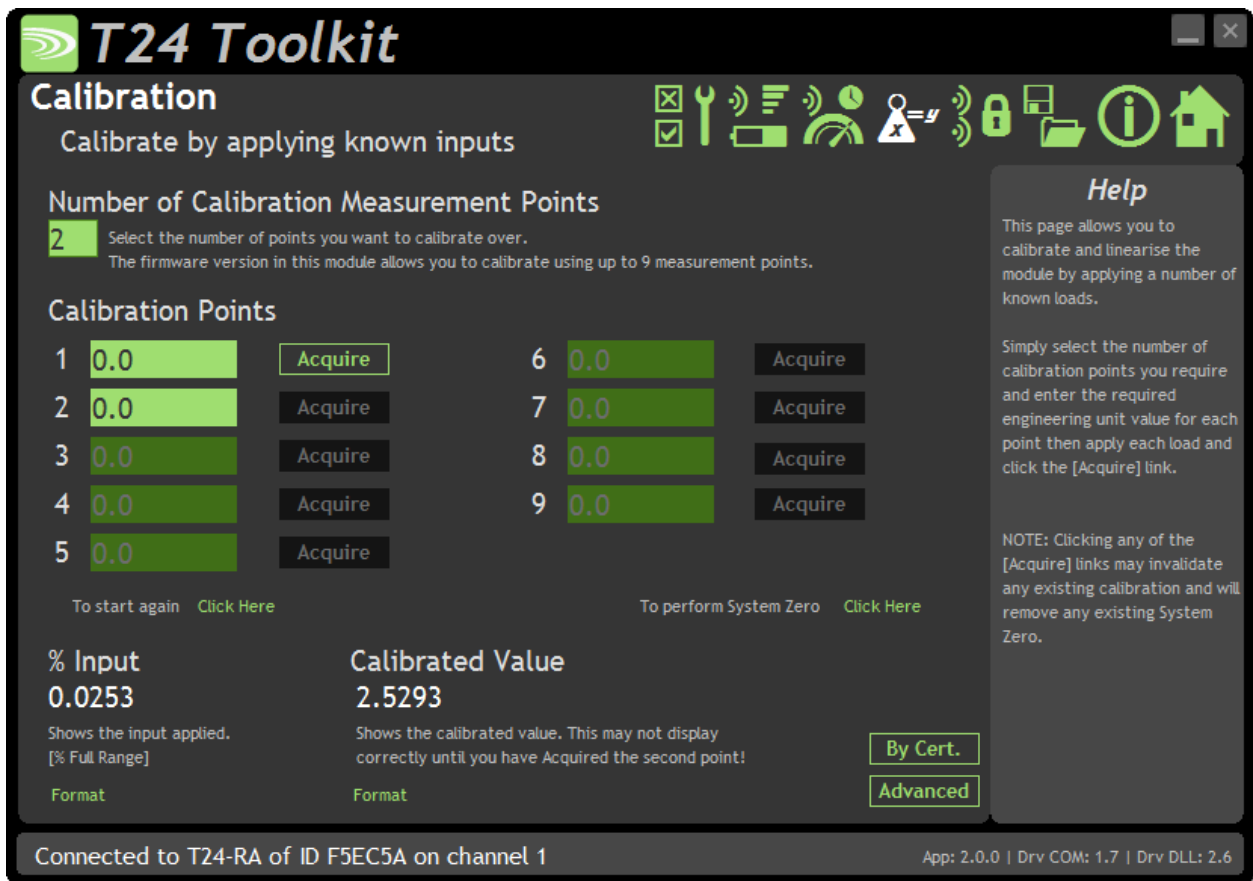

The module is factory calibrated to provide between 0% and 100% output value when the positive input varies between the negative and positive excitation.

Here you can calibrate the transmitter module and set a system zero if required.

This simple page allows semi-automated calibration where you can apply known inputs to calibrate.

This calibration includes linearization and is automatically applied.

See later for **By Cert** and **Advanced** page where you can adjust individual gains and offsets.

### Calibration Process

- Decide on how many points you will calibrate over.
- Decide what inputs will be applied (in ascending order) at each point.
- Enter the actual input (in the required units) that you want the module to read at each point.
- Now proceed to apply each input in turn (allowing a settle time) and click the **Acquire** button at that point. You can now apply the next input and click **Acquire** until all the points are completed.

The bottom of the page shows the **Input Value** and the **Calibrated Value**. Once the second point has been acquired this **Calibrated Value** should display the actual calibrated value.

### Items you can change:

Number of Calibration Points    Enter the number of points you wish to calibrate over. In its simplest form you could select two for a linear calibration. For more complex calibrations which include linearization select three to nine points.

Point 1 - 9    For each point enter the engineering unit value that you want the transmitter module to report at the applied input. i.e. 1.67

Acquire 1 - 9	Click this button when the input has been applied and the reading has been allowed to settle. This will acquire the reading and allow you to move to the next points. You will be able to click the button again to re-acquire.
Start Again	Click here to restart the calibration.
System Zero	Once calibrated you may want to remove a fixed system value. In the case of a strain gauge input this may be the weight of a sling, shackle, load bed etc. Apply the required input and click here to set the system zero. The current input will be removed from subsequent readings so that the reading will be zero. To edit this value manually click the <b>Advanced</b> button. System Zero is stored in non-volatile memory in the transmitter module.
By Cert.	You can click the <b>By Cert</b> button to calibrate against a sensor calibration sheet. You just need to enter the input values and associated engineering unit required output value of at least 2 points. This will take you to a different screen.
Advanced	Clicking the advanced button will allow you to edit the gains and offsets for each available calibration point. This will take you to a different screen.



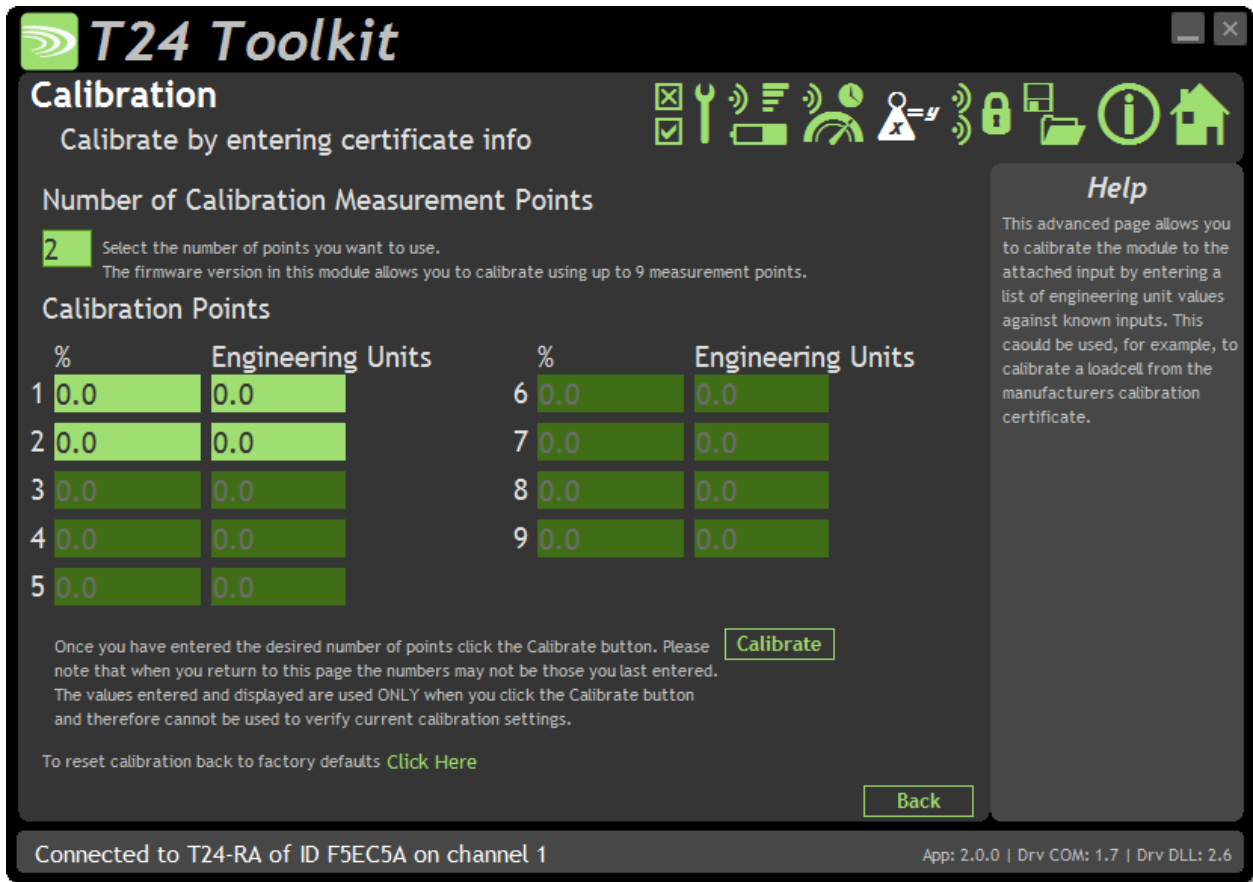

In some circumstances it may not be possible to apply inputs in which case the calibration can be entered manually from the calibration table or certificate without ever having to connect the input.

**Items you can change:**

- Number of Calibration Points    Enter the number of points you wish to calibrate over. In its simplest form you could select two for a linear calibration. For more complex calibrations which include linearization select three to nine points.
- Input Points 1 – 9  
( shown in this screenshot)    Enter the input point for which you will specify a required engineering output value
- Engineering Units 1 - 9    Enter the required engineering unit output for the specified input value
- Calibrate    Click this button to calculate and update the module calibration

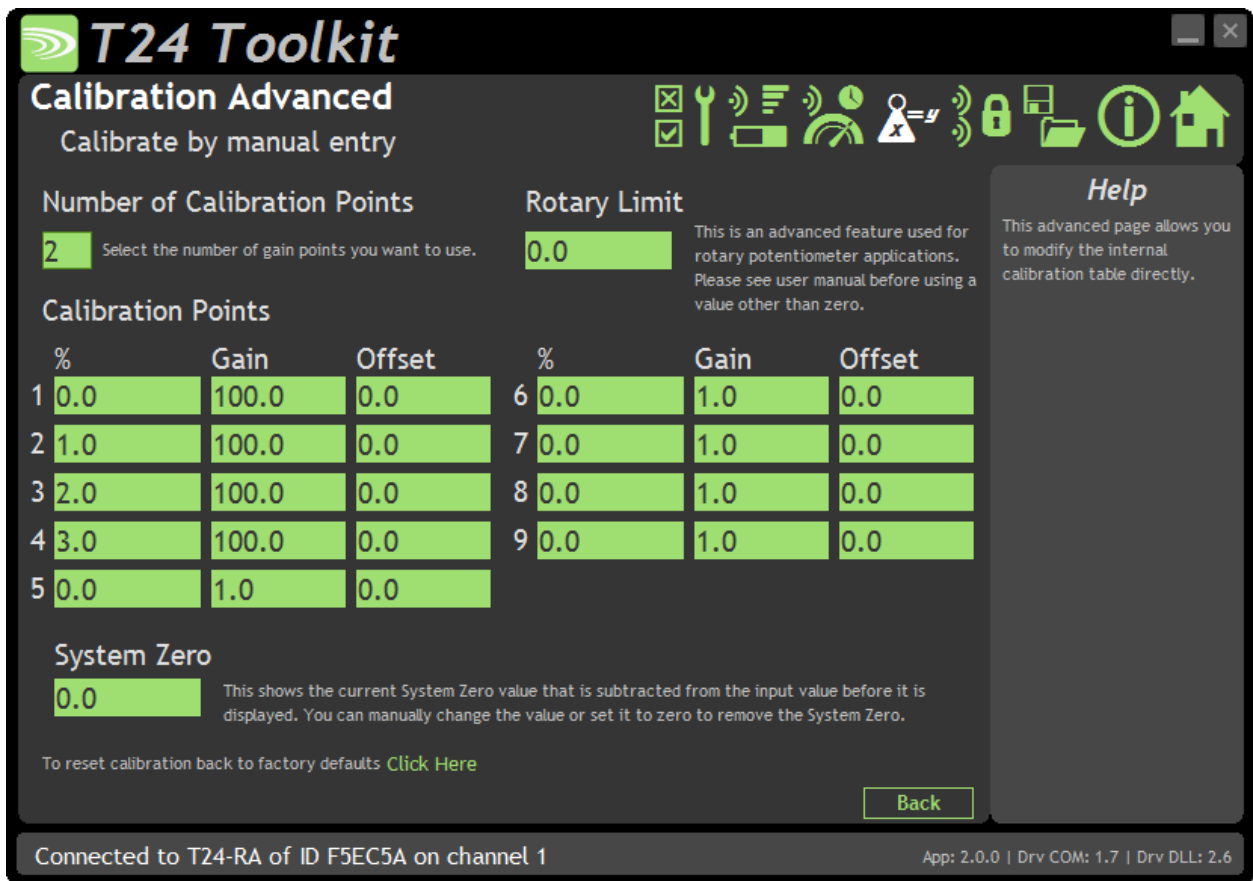

In some circumstances it may not be possible to apply inputs in which case the calibration can be entered manually.

For example, if a sensor manufacturer provides a calibration table for a cell it may be possible to calculate gains and offsets and enter these values into the Advanced Calibration page without having to connect the input sensor.

**Items you can change:**

**Number of Calibration Points** Enter the number of points you wish to calibrate over. In its simplest form you could select two for a linear calibration. For more complex calibrations which include linearization select three to nine points.

**Input Points 1 – 9** (mV/V shown in this screenshot) Enter the input point to which the associated interpolated gain and offset values will be applied. Note between points the gain and offset values are linearly interpolated. Inputs are extrapolated below point 1 and above point 9.

**Gain 1 – 9** Enter the gain value for associated point

**Offset 1 - 9** Enter the Offset value for associated point

**Rotary limit** This is the value at which the input will move from maximum to minimum value. This is useful for applications where the potentiometer input is endless i.e. moves from the maximum to the minimum as it wraps round. This parameter stops the unit reporting values outside the viable input range.

**System Zero** You can set the system zero value here or set it to zero to remove the system zero effect.

### **Description of Linearisation Calculations**

The input value is looked up in a table of points which is dependent on what the user has selected, starting from the bottom of the table. When a point is found to which the input is less than then this point and the previous point are used to extrapolate a gain and offset from. This leads to a resultant gain and offset which is applied to the mV/V values as follows.

Value = (input \* Resultant Gain) - Resultant Offset.

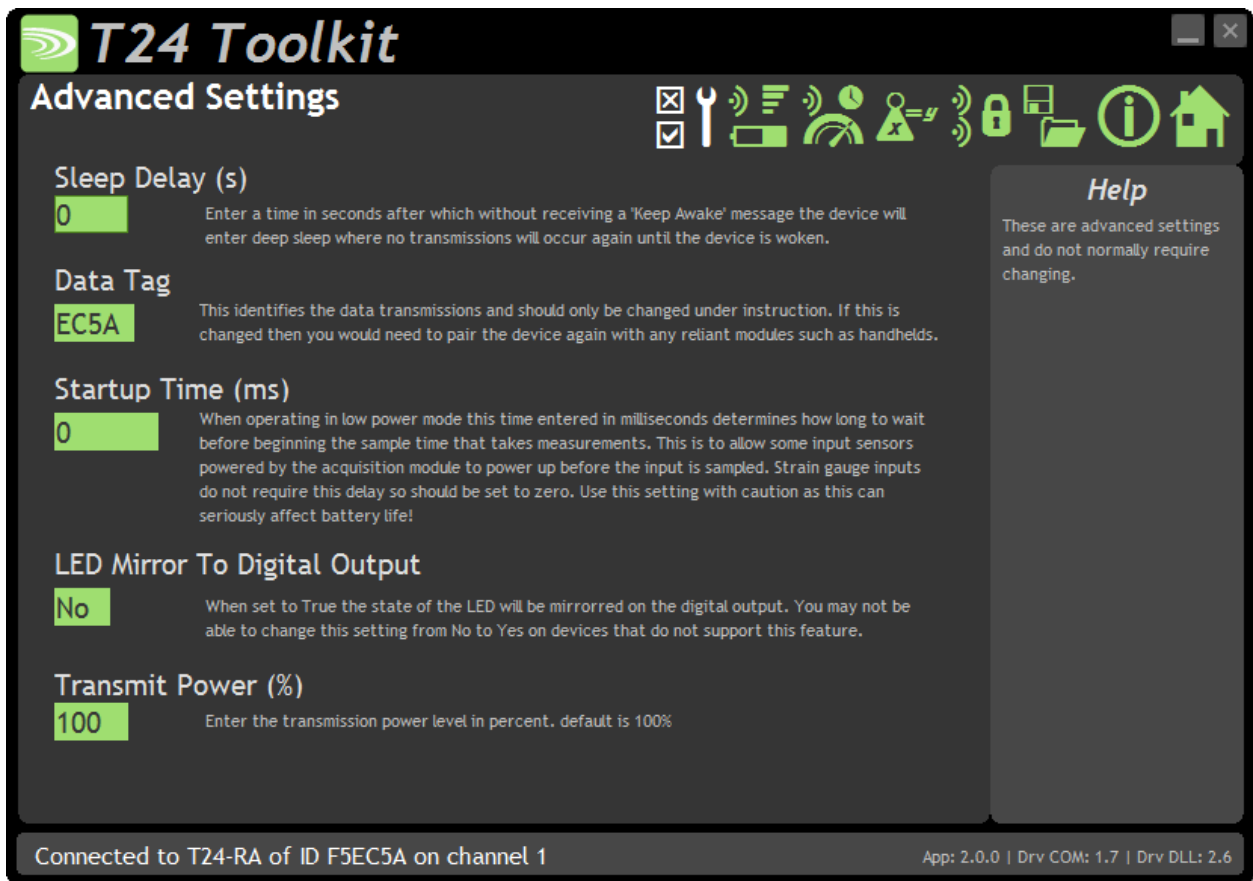

You should not normally need to change these settings.

**Items you can change:**

- Sleep Delay                      Here you can enter a delay in seconds after which the transmitter module will return to deep sleep if no Keep Awake message is heard from the T24-HS handheld. The default is 60 seconds.
- Data Tag                              The data transmitted by the transmitter module is marked with a Data Tag which is a 2 byte hexadecimal code. By default this is set to the last 2 bytes of the module ID (or to put it another way, the last 4 characters of the module ID). If by some chance you had two transmitter module modules that would be working on the same channel and had the same last 4 characters in their ID (1 in 65,535 chances) you may want to change the data Tag of one of the modules and perform pairing again with the T24-HS handheld.
- Startup Time                         Some transmitter modules power a sensor from their excitation voltage. When coupled to a sensor with a slow startup time this setting is used to delay the measurement after wakeup from sleep between readings. This gives the sensor time to settle at the expense of battery life. For strain gauge inputs this settings should be zero.
- LED Mirror to Digital Output      When set to Yes each time the LED is active the digital output is active. This can be useful if the module is to be encapsulated or enclosed and enables a second LED to be externally mounted. This is very useful when using a T24-HR roaming handheld as the transmitter module LED will activate while the handheld is in communications with the module.
- Transmit power                      Set the transmit power level from 0 – 100%. Default is 100%

---

## Enclosure & Mounting

This module is available in a number of different enclosure types. Locate your module and follow the link to view dimensional and mounting information for that particular enclosure.

---

### T24-RAe, T24-RAi

These OEM modules are bare PCB modules. Please see [Appendix A – Enclosures & Mounting – OEM Transmitter Modules](#) for more information.

---

### T24-ACM-RA

This module is fitted inside our large enclosure. Please see [Appendix A – Enclosures & Mounting – ACM](#) for more information.

---

### T24-ACMi-RA

This module is fitted inside our medium enclosure. Please see [Appendix A – Enclosures & Mounting – ACMi](#) for more information.

---

### T24-ACMm-RA

This module is fitted inside our small enclosure. Please see [Appendix A – Enclosures & Mounting – ACMm](#) for more information.

---

## Antennas

---

### T24-RAi

This module uses an integrated chip antenna. See [Appendix B – Antennas – Internal Chip Antenna](#)

---

### T24-RAe

Only the T24-RAe module allows for the fitting of external antennas. The choices are:

T24-ANTA	PCB Antenna	See <a href="#">Appendix B – Antennas – T24-ANTA</a>
T24-ANTB	Dipole Antenna	See <a href="#">Appendix B – Antennas – T24-ANTB</a>
T24-ANTC	Dipole Antenna Swivel	See <a href="#">Appendix B – Antennas – T24-ANTC</a>
T24-ANTD	Puck Antenna SMA	See <a href="#">Appendix B – Antennas – T24-ANTD</a>
T24-ANTE	Puck Antenna UFL	See <a href="#">Appendix B – Antennas – T24-ANTE</a>

---

### T24-ACM-RA, T24-ACMi-RA, T24-ACMm-RA

These modules have the antenna already fitted inside the enclosure so there are no specific mounting requirements.

## Specification

Specification at 3V supply at 25°C

Measurement	Min	Typical	Max	Units
Sensor Excitation Voltage	2.4	2.5	2.6	Vdc
Input Range	500		100,000	Ω
Accuracy		0.01		% of Full Scale

Environmental	Min	Typical	Max	Units
Operating Temperature Range	-20		+55	°C
Storage Temperature	-40		+85	°C
Humidity	0		95	%RH

Power Supply	Min	Typical	Max	Units
Standby / Low Power Mode		5	20	μA
Normal Mode on constantly		55	60	mA
<b>T24-RAe, T24-RAi, T24-ACMi-RA, T24-ACMm-RA</b>				
Power Supply voltage	2.1	3.0	3.6	Vdc
Power Supply ripple			50	mV ac pk-pk
Normal Mode		60	65	mA (1)
<b>T24-ACM-RA</b>				
Power Supply voltage	5		18	Vdc
Power Supply ripple			50	mV ac pk-pk
Normal Mode		60	65	mA (1)

1. Power supply must be capable of supplying 300 mA for 250 μs (Required on start up, waking and during low power operation)

Battery Life in Low Power Mode Generating Results at 3Hz	Usage	Battery Life
Pair AA cells	Constantly on	1 month
Pair AA cells	12 sessions per day of 5 minutes	2 years
Pair D cells	Constantly on	4.5 months
Pair D cells	12 sessions per day of 5 minutes	> 9 years

## Radio Range

To determine radio range please refer to [Appendix B – Antenna Range](#)

---

## T24-ACM-PA, T24-ACMi-PA, T24-ACMm-PA, T24-PAe, T24-PAi

---

### Overview

The T24-PA is a remote transmitter module for the collection and processing of pulse related measurements. This includes measuring the period between pulses to provide outputs in Hz, RPM and Time as well as actual pulse counting.

---

### Order Codes

---

#### T24-PAe



Pulse transmitter module with external antenna UFL connector.

#### T24-PAi



Pulse transmitter module with integral antenna.

---

#### T24-ACM-PA



Pulse transmitter module mounted in large weatherproof enclosure with battery holder for two D cell alkaline batteries. Also has ability to be powered from external supply voltage.

#### T24-ACMi-PA



Pulse transmitter module mounted in medium weatherproof enclosure with battery holder for two AA batteries.

---

#### T24-ACMm-PA



Pulse transmitter module mounted in small enclosure with screw terminals to connect external 3 V power supply.

---



---

## Connections

---

### T24-PAe, T24-PAi

---

#### Power

Attach power supply wiring to the module as shown below:

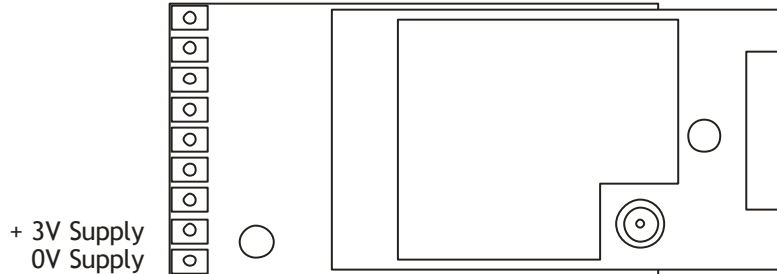

Connect to a 3 Volt power supply or batteries.



This module is **not** reverse polarity protected!  
The maximum voltage is 3.6 V!

For battery information please refer to [Appendix D – Battery Selection](#)

---

#### Sensor

Pulse input connected as follows:

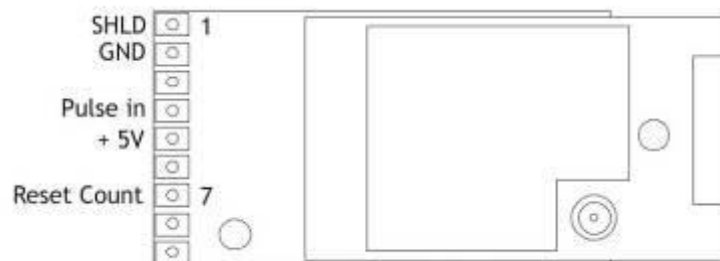

The 'Pulse in' input incorporates a pull-up resistor enabling a 'volt-free' contact to be used as the input source. This can take the form of a normally open or normally closed switch or relay contacts.

A normally open contact connected between 'Pulse in' and 'GND' will generate a negative edge when it operates. In this case set 'Edge Type' to 'Falling' in the 'Input/Output Configuration' page of the T24 Toolkit.

'Edge Type' should be set to 'Rising' to accommodate a normally closed contact when it opens.

The T24-PA can also be used with a repetitive sine, square or pulse wave signal source such as a signal generator or RPM sensor. The amplitude should be between 0.8 V and 6 V peak.

A maximum of 40 mA can be drawn from the '5V' supply pin to power a pulse generating sensor. By setting a value in 'Startup Time' in the T24 Toolkit 'Advanced Settings' page the time taken for the sensor to start up and become stable after a 'sleep' period can be accounted for by delaying the sampling until this period has elapsed.

Reset Count is a 'volt-free' contact input. This can be used to reset the count input to zero. To activate connect 'Reset Count' to GND.

---

## Relay & Volt Free Contact

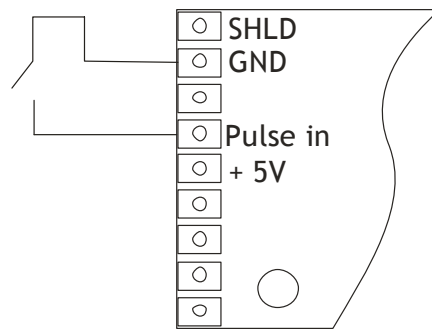

---

## Voltage Source

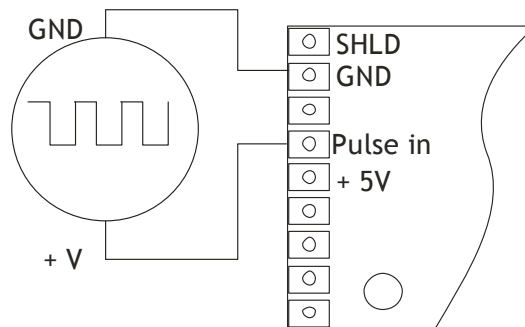

---

## NPN Open Collector

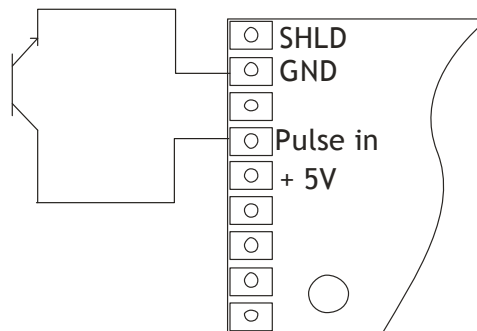

---

## T24-ACM-PA

### Power

Power can be supplied by fitting two D cell alkaline 1.5 V batteries or the module can be supplied from an external 5 Vdc to 18 Vdc source.

In both cases you need to fit the JP1 power jumper to supply power to the transmitter module.

When powered from the external DC source the LED will illuminate.

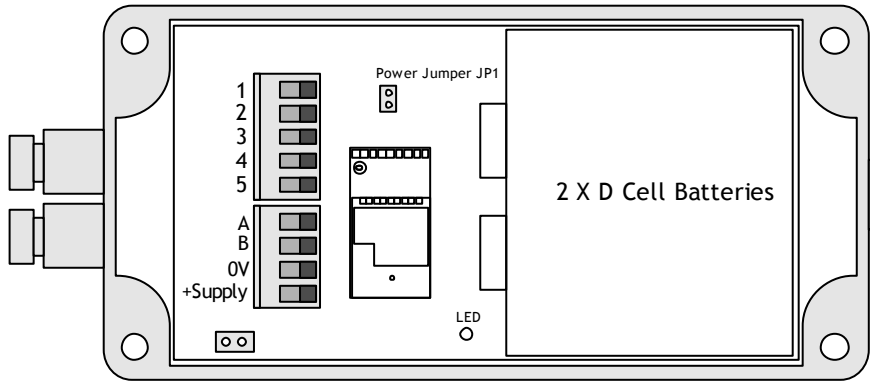

For battery information please refer to [Appendix D – Battery Selection](#)

### Sensor

The pulse input is connected to the module via a 2 part screw terminal block.

Screw Terminal	Function
1	+5 V Excitation
2	Pulse In
3	Not Connected
4	-Excitation (GND)
5	Shield
A	
B	

See [T24-PAe](#), [T24-PAi](#) section above for wiring options.

---

## T24-ACMi-PA

---

### Power

The enclosure is designed to accept two AA batteries. Maximum voltage 1.8 V per cell.

For battery information please refer to [Appendix D – Battery Selection](#)

---

### Sensor

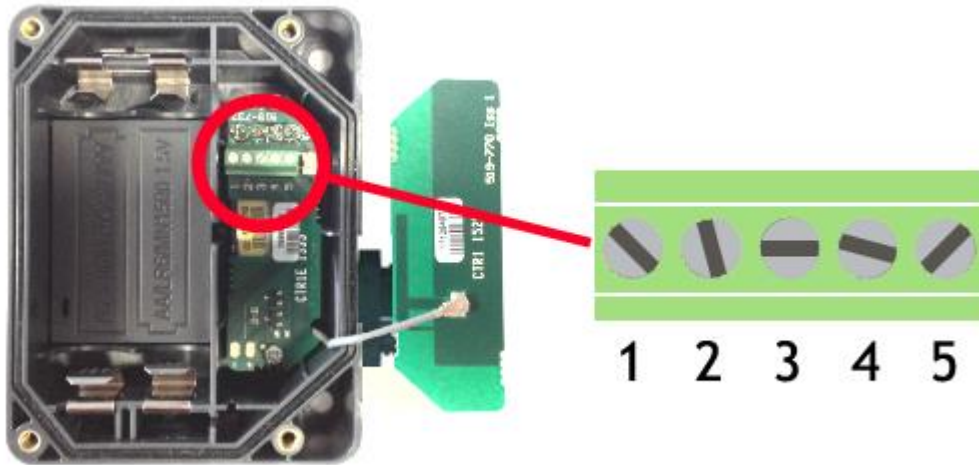

The input connections are accessed by lifting the right hand cover plate, this plate incorporates the T24-ACMi Antenna; take extra care when re-assembling that the grey UHF cable is attached to the antenna socket.

Screw Terminal	Function
1	Shield
2	-Excitation (GND)
3	Not Connected
4	Pulse In
5	+ 5 V Excitation

See [T24-PAe](#), [T24-PAi](#) section above for wiring options.

---

## T24-ACMm-PA

---

### Power

Power is supplied by connecting a 3V supply to the pins shown below.

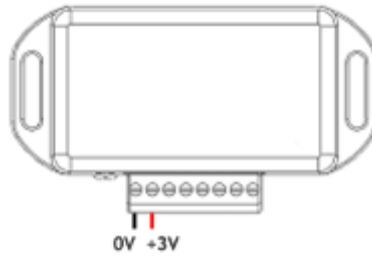

**!** There is no reverse polarity protection.

---

### Connecting T24-BB1

Power to transmitter modules in this enclosure can also be supplied by a T24-BB1 battery box which contains two AA 1.5 V batteries.

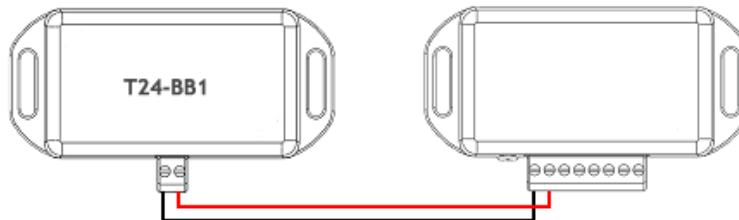

For battery information please refer to [Appendix D – Battery Selection](#)

---

### Sensor

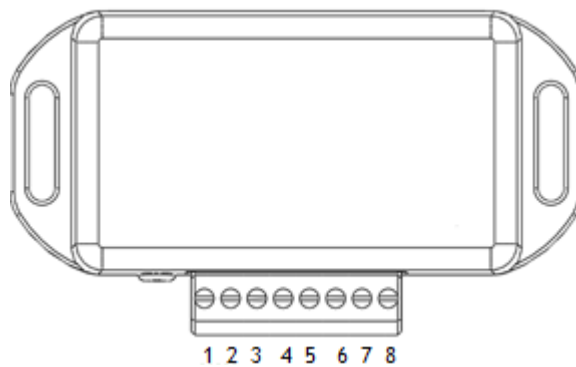

Screw Terminal	Function
5	-Excitation (GND)
6	+Not Connected
7	-Pulse In
8	+5 V Excitation

See [T24-PAe](#), [T24-PAi](#) section above for wiring options.

---

## Shield Connections (All Enclosures)

We recommend the following rules to determine whether there should be a connection between the transmitter module shield and the sensor chassis or cable:

1. If the sensor is remote to the transmitter module and the screen of the signal cable is **NOT** connected to the sensor chassis then the cable screen **should** be connected to the transmitter module shield connection.
2. If the sensor is remote to the transmitter module and the screen of the signal cable **IS** connected to the sensor chassis then the cable screen should **NOT** connected to the transmitter module shield connection.
3. If the transmitter module is integral to the sensor or mounted very close and the module is mounted on a metal chassis then the answer to whether the transmitter module shield connection should be connected to the metal chassis is a matter of experimentation. This connection must be as short as possible. The T24 Toolkit can be used to chart the signal levels and tests should be undertaken to determine whether there is a better radio signal with or without the shield/chassis connection. The quality of the measured reading should also be looked at. In cases where the shield/chassis connection makes no difference to the radio signal or the reading quality then the connection should be made.

## Configuration

The T24 Toolkit provides a means of simple configuration and calibration of the transmitter module along with useful tools to aid integration.

Launch the T24 Toolkit software application and pair to this module to enable the connection to the Toolkit to allow configuration to take place. [See Common Toolkit Pages - Home](#)

## Data Rates and Quality

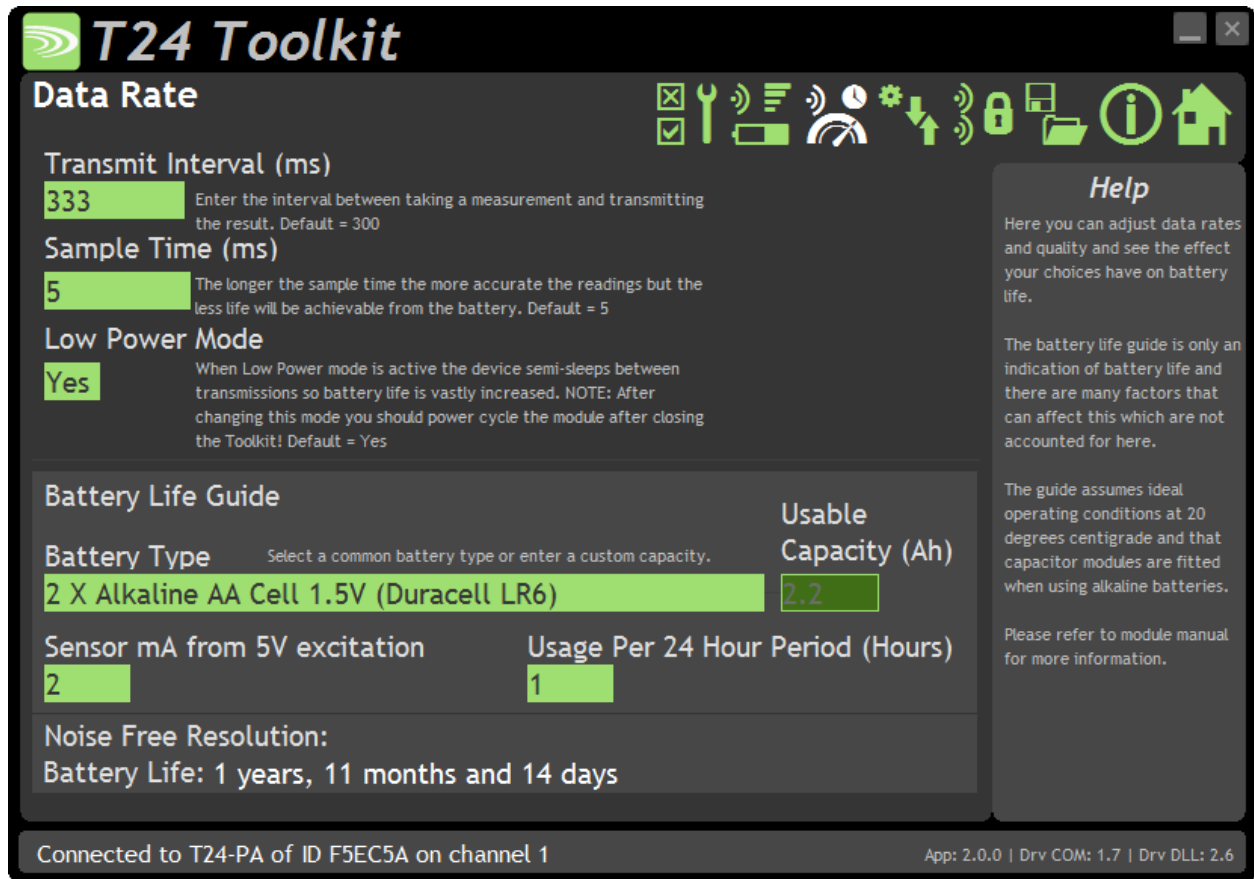

This page allows you to select the rate at which data is transmitted from the transmitter module and the quality. By selecting low power mode and entering some other information the toolkit will also give guides on achievable battery life.

Note that the battery life calculator is assuming the best case scenario which is at 20°C and that the battery has a suitable low internal resistance or that a suitable capacitor is fitted across the battery. See battery details in the Installation section.

### Items you can change:

Transmit Interval

Enter the transmission rate in milliseconds. The default is 300 giving approximately 3 per second which is ideally suited to reading on a handheld. You may want to slow this down to achieve longer battery life.

Sample Time	<p>This is the length of time in milliseconds that the input is sampled before the value is transmitted. This can vary between 5 milliseconds and close to the Transmit Interval.</p> <div style="border: 1px solid #90EE90; padding: 10px; margin: 10px 0;"> <p><b>i</b> <i>The Sample time should be set to at least twice the maximum time period that is to be captured to ensure accurate capture of incoming pulses.</i></p> </div> <p>A shorter sample time means that the module is awake for less time so battery life is increased but at the expense of a reading with less noise free resolution. You can vary this to see the effect on battery life.</p>
Low Power Mode	<p>Unless the transmitter module is non battery powered this should be set to Yes. In between transmissions the transmitter module will enter sleep mode which, for some modules such as the strain gauge transmitter module, will have a massive effect on battery life.</p> <p>A Reason for <b>not</b> using Low Power Mode would be if using the module in a Master-Slave arrangement with PC for example.</p>
Battery Type	<p>This is not a parameter of the module but information used by the battery life guide. You can choose from some preset batteries or choose custom to allow you to select your own battery capacity. See below. This will also offer to change the Battery Low Level if the level suitable for the chosen battery is not the level currently set.</p>
Usable Capacity	<p>This is not a parameter of the module but information used by the battery life guide. This is the capacity of the battery in amp hours and has a profound effect on battery life calculations. This capacity needs to be calculated from battery manufacturer's data sheets to take into account that you can only use batteries down to 2.1 volts so in the case of twin AA cells this would be 1.05 volts. Generally the usable capacity will not be as high as that advertised by the battery manufacturer. Temperature and internal resistance of the battery are not taken into account in the guide.</p>
Sensor mA from 5V Excitation	<p>This is the current drawn by any sensor attached to the 5 V on board power supply.</p>
Usage Per 24 Hour Period	<p>Enter the number of hours per 24 hour period that the module will be turned on and transmitting.</p>





This module does not provide calibration, as such, because it is factory calibrated. However, on this page you can select the output type and parameters unique to your input sensor.

**Items you can change:**

- Output Type
  - Simply select the required output type from the drop down list.
  - Frequency (Hz)** – Average frequency of pulses measured over the sample time
  - Time (s)** – Average time in seconds between pulses measured over the sample time
  - RPM** – Average Revolutions Per Minute measured over the sample time.
  - Counter** – Counts incoming pulses. Count is reset by digital input to GND or external reset using data provider packet .Should not be used in low power mode
  
- Pulses per Revolution
  - Specify the number of pulses per revolution. This parameter only affects the RPM output value.
  
- Edge Type
  - Define which edge of an input pulse should be counted as the input trigger
  
- Debounce Filter
  - Enter a time in milliseconds, any pulse that is received within this time of a previous pulse will be ignored, this is useful when dealing with noisy inputs such as relays which may inadvertently produce more than one pulse per event.
  
- Ignore First Pulse
  - If set to yes the T24-PA will ignore first pulse received during the sample time, before continuing to average the time between the subsequent pulses. This is useful in situation where a sensor may be powered by the transmitter module and may produce an erroneous pulse on start up.

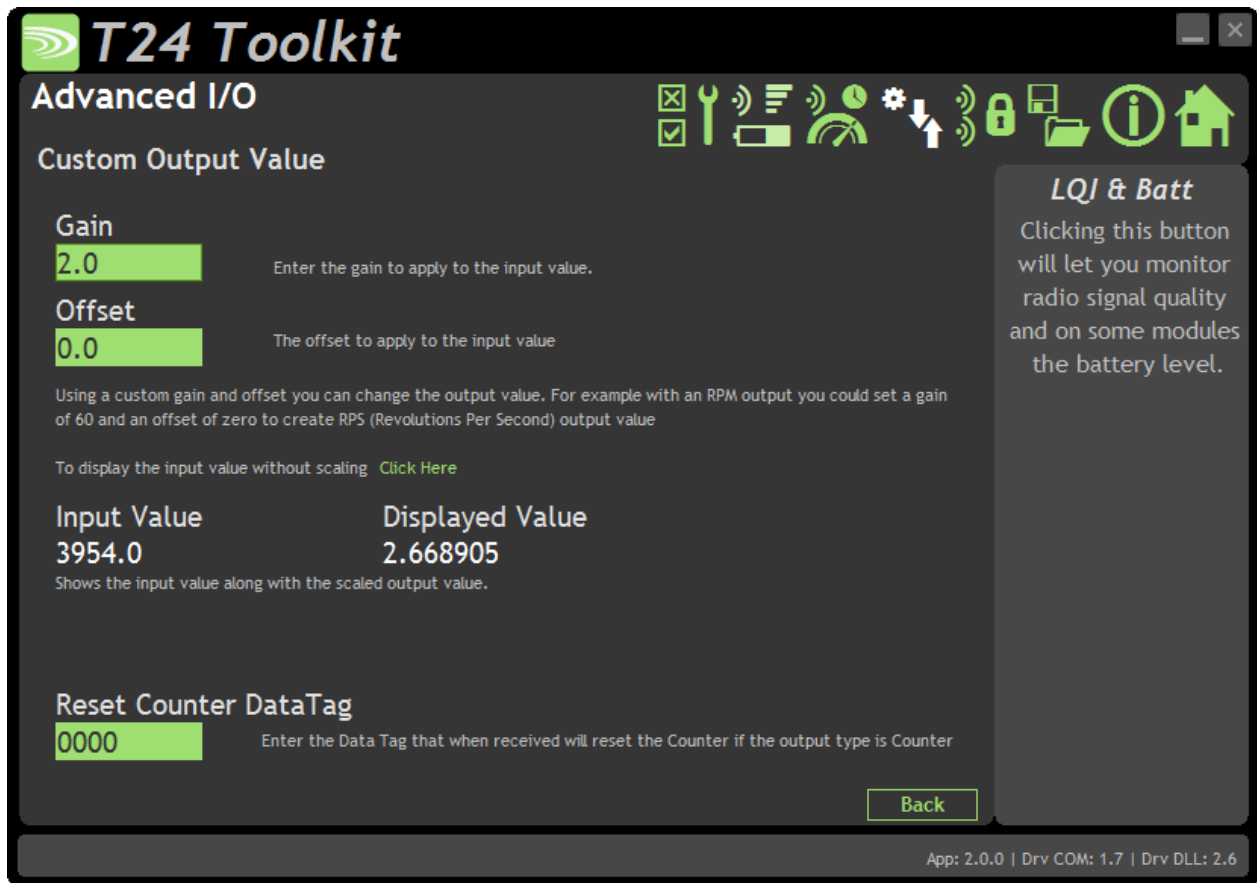

This module does not provide calibration, as such, because it is factory calibrated. However, on this page you can adjust the gain to provide different output Types.

### Custom Output Type

**Items you can change:**

- Gain Default is 1. If the gain value is set the output value of the module will be multiplied by the gain before transmission. This setting only applies to Frequency; Time & RPM outputs not the counter.
  
- Offset Default is 0. If the offset value is set the output value of the module will be multiplied by the gain and the offset subtracted before transmission. This setting only applies to Frequency; Time & RPM outputs not the counter.
  
- Reset Counter Data Tag If using the counter output the data tag specified in this field will cause the counter in the T24-PA to reset to zero whenever a data packet with this data tag is detected. Data providers can be produced by other transmitter modules, T24-HA or custom software

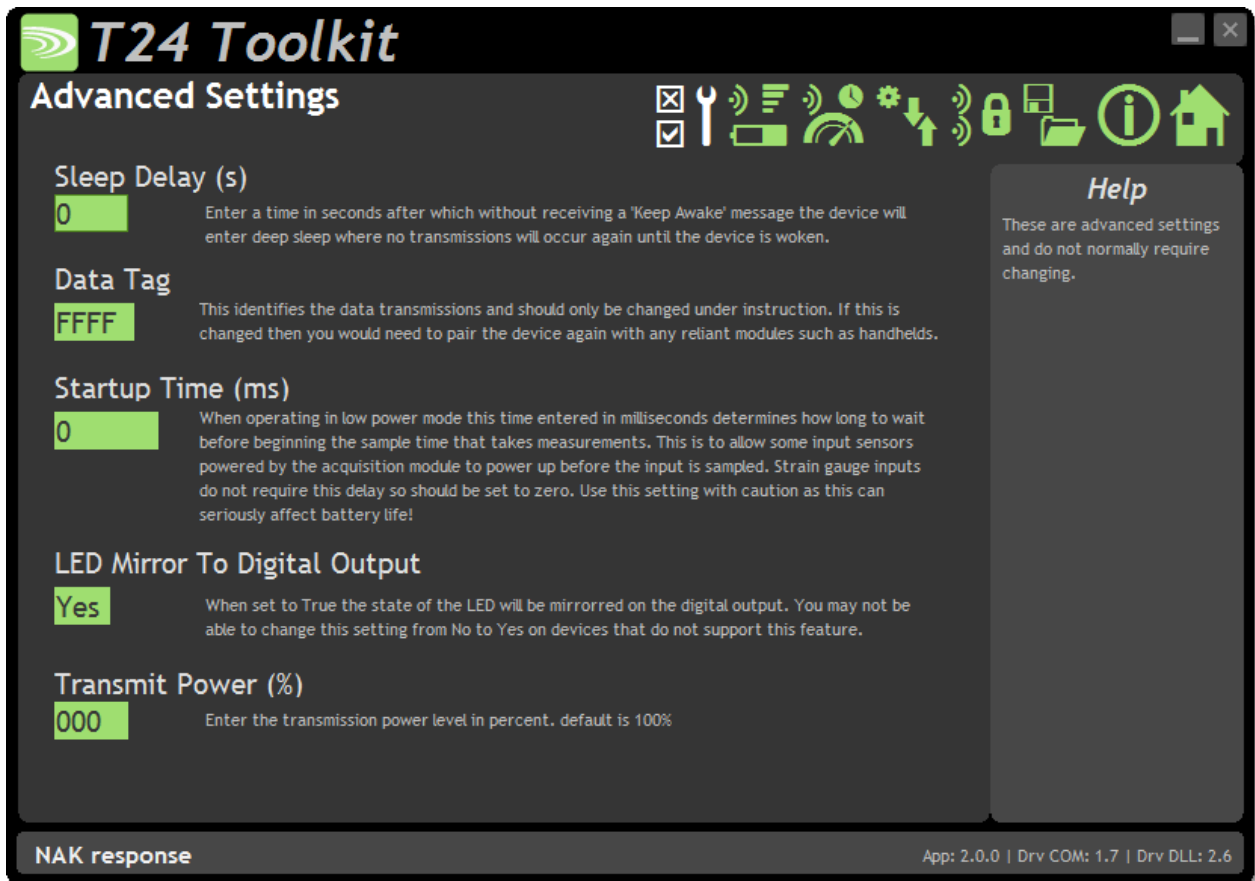

You should not normally need to change these settings.

**Items you can change:**

- Sleep Delay** Here you can enter a delay in seconds after which the transmitter module will return to deep sleep if no Keep Awake message is heard from the T24-HS handheld. The default is 60 seconds.
- Data Tag** The data transmitted by the transmitter module is marked with a Data Tag which is a 2 byte hexadecimal code. By default this is set to the last 2 bytes of the module ID (or to put it another way, the last 4 characters of the module ID). If by some chance you had two transmitter module modules that would be working on the same channel and had the same last 4 characters in their ID (1 in 65,535 chances) you may want to change the data Tag of one of the modules and perform pairing again with the T24-HS handheld.
- Startup Time** Some transmitter modules power a sensor from their excitation voltage. When coupled to a sensor with a slow startup time this setting is used to delay the measurement after wakeup from sleep between readings. This gives the sensor time to settle at the expense of battery life. For strain gauge inputs this settings should be zero.
- LED Mirror to Digital Output** When set to Yes each time the LED is active the digital output is active. This can be useful if the module is to be encapsulated or enclosed and enables a second LED to be externally mounted. This is very useful when using a T24-HR roaming handheld as the transmitter module LED will activate while the handheld is in communications with the module.
- Transmit power** Set the transmit power level from 0 – 100%. Default is 100%

---

## Enclosure & Mounting

This module is available in a number of different enclosure types. Locate your product and follow the link to view dimensional and mounting information for that particular enclosure.

---

### T24-PAe, T24-PAi

These OEM modules are bare PCB modules. Please see [Appendix A – Enclosures & Mounting – OEM Transmitter Modules](#) for more information.

---

### T24-ACM-PA

This module is fitted inside our large enclosure. Please see [Appendix A – Enclosures & Mounting – ACM](#) for more information.

---

### T24-ACMi-PA

This module is fitted inside our medium enclosure. Please see [Appendix A – Enclosures & Mounting – ACMi](#) for more information.

---

### T24-ACMm-PA

This module is fitted inside our small enclosure. Please see [Appendix A – Enclosures & Mounting – ACMm](#) for more information.

---

## Antennas

---

### T24-PAi

This module uses an integrated chip antenna. See [Appendix B – Antennas – Internal Chip Antenna](#)

---

### T24-PAe

Only the T24-PAe module allows for the fitting of external antennas. The choices are:

T24-ANTA	PCB Antenna	See <a href="#">Appendix B – Antennas – T24-ANTA</a>
T24-ANTB	Dipole Antenna	See <a href="#">Appendix B – Antennas – T24-ANTB</a>
T24-ANTC	Dipole Antenna Swivel	See <a href="#">Appendix B – Antennas – T24-ANTC</a>
T24-ANTD	Puck Antenna SMA	See <a href="#">Appendix B – Antennas – T24-ANTD</a>
T24-ANTE	Puck Antenna UFL	See <a href="#">Appendix B – Antennas – T24-ANTE</a>

---

### T24-ACM-PA, T24-ACMi-PA, T24-ACMm-PA

These modules have the antenna already fitted inside the enclosure so there are no specific mounting requirements.

## Specification

Specification at 3V supply at 25°C

Measurement	Min	Typical	Max	Units
Sensor Excitation Voltage	4.5	5	5.25	Vdc
Input Range in Period	333 x10 <sup>-6</sup>	-	2	sec
Input Range in Frequency	0.5	-	3,000	Hz
Input Range in RPM (presuming 1 pulse / rev)	30	-	180,000	RPM
Accuracy % input error @ 1 Hz	-	-	0.15	%
Accuracy % input error @ 1 kHz	-	-	0.175	%
Accuracy % input error @ 2 kHz	-	-	0.2	%
Accuracy % input error @ 3 kHz	-	-	0.25	%
Accuracy interval resolved to		0.25		μ sec

Environmental	Min	Typical	Max	Units
Operating Temperature Range	-20		+55	°C
Storage Temperature	-40		+85	°C
Humidity	0		95	%RH

Power Supply	Min	Typical	Max	Units
Standby / Low Power Mode		5	20	μA
Normal Mode on constantly		55	60	mA
<b>T24-PAe, T24-PAi, T24-ACMi-PA, T24-ACMm-PA</b>				
Power Supply voltage	2.1	3.0	3.6	Vdc
Power Supply ripple			50	mV ac pk-pk
Normal Mode (1K Bridge)		60	65	mA (1)
<b>T24-ACM-PA</b>				
Power Supply voltage	5		18	Vdc
Power Supply ripple			50	mV ac pk-pk
Normal Mode		60	65	mA (1)

1. Power supply must be capable of supplying 300 mA for 250 μs (Required on start up, waking and during low power operation)

Battery Life in Low Power Mode Generating Results at 3Hz	Usage	Battery Life
Pair AA cells	Constantly on	1 month
Pair AA cells	12 sessions per day of 5 minutes	2 years
Pair D cells	Constantly on	4.5 months
Pair D cells	12 sessions per day of 5 minutes	> 9 years

## Radio Range

To determine radio range please refer to [Appendix B – Antenna Range](#)

---

## T24-WSS

---

### Overview

The T24-WSS wireless anemometer is built on the same technology as previous Load Cell Central wireless sensor interfaces offering the same sleep and wake functionality and operation with peripheral modules including handhelds, USB base stations and GPRS data loggers.

The Anemometer features a high quality 3-cup rotor pressed on a stainless steel shaft with rugged Delrin body with bronze Rulon bushings

The output value of the anemometer can be configured to the user's requirements and measure over the range 5 to 125 mph.

Accuracy:

- 0.5mph from 5 to 10 mph
- $\pm 4\%$  from 10 to 125 mph

The T24-WSS is powered either from internal batteries or an external supply. For applications which require high sampling rates for long periods Mantracourt's PowerPack and SolarPanel ([PP1](#) & [SP1](#)) offers an ideal solution.

---

### Order Codes

---

#### T24-WSS



Pulse transmitter module mounted in large weatherproof enclosure with battery holder for two D cell alkaline batteries. Also has ability to be powered from external supply voltage.

---

---

## Connections

---

### Power

Power can be supplied by fitting two D cell alkaline 1.5 V batteries or the module can be supplied from an external 5 Vdc to 18 Vdc source. The module will switch to the external supply in preference providing a battery backup.

In both cases you need to fit the JP1 power jumper to supply power to the transmitter module. When powered from the external DC source the LED will illuminate.

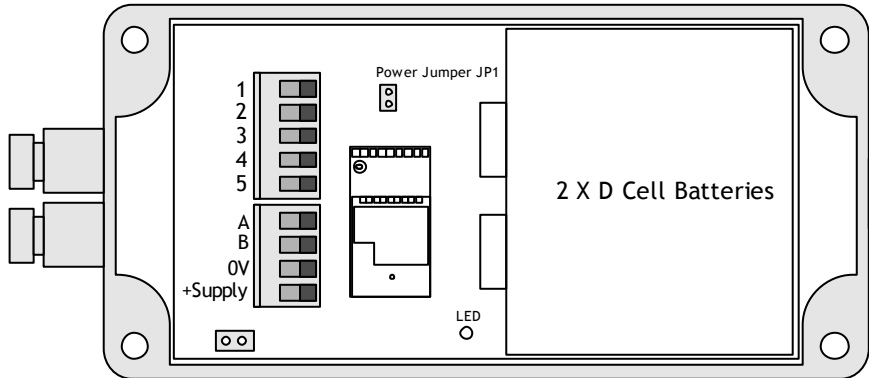

For battery information please refer to [Appendix D – Battery Selection](#)

---

## Configuration

The T24 Toolkit provides a means of simple configuration and calibration of the transmitter module along with useful tools to aid integration.

Launch the T24 Toolkit software application and pair to this module to enable the connection to the Toolkit to allow configuration to take place. [See Common Toolkit Pages - Home](#)





This page allows you to select the rate at which data is transmitted from the transmitter module and the quality. By selecting low power mode and entering some other information the toolkit will also give guides on achievable battery life.

Note that the battery life calculator is assuming the best case scenario which is at 20°C and that the battery has a suitable low internal resistance or that a suitable capacitor is fitted across the battery. See battery details in the Installation section.

**Items you can change:**

**Transmit Interval** Enter the transmission rate in milliseconds. The default is 2000 giving a reading every two seconds. You may want increase this value to slow transmissions down to achieve longer battery life.

**i** In order to capture wind speed of 3.5 mph the Sample time must be 1000ms so the minimum TX interval is at 1000.

**Sample Time** This is the length of time in milliseconds that the input is sampled before the value is transmitted.

**!** WARNING - CHANGING THIS VALUE WILL EFFECT THE INPUT RANGE OF THE SENSOR

The default value is 1000ms allowing for wind speeds from 3.5 mph upward to be captured.

Low Power Mode	<p>Unless the transmitter module is non battery powered this should be set to Yes. In between transmissions the transmitter module will enter sleep mode which, for some modules such as the strain gauge transmitter module, will have a massive effect on battery life.</p> <p>A Reason for <b>not</b> using Low Power Mode would be if using the module in a Master-Slave arrangement with PC for example. Or if there is less than 40ms between the sample time and transmit interval.</p>
Battery Type	<p>This is not a parameter of the module but information used by the battery life guide. You can choose from some preset batteries or choose custom to allow you to select your own battery capacity. See below. This will also offer to change the Battery Low Level if the level suitable for the chosen battery is not the level currently set.</p>
Usable Capacity	<p>This is not a parameter of the module but information used by the battery life guide. This is the capacity of the battery in Amp Hours and has a profound effect on battery life calculations. This capacity needs to be calculated from battery manufacturer's data sheets to take into account that you can only use batteries down to 2.1 volts so in the case of twin AA cells this would be 1.05 volts.</p> <p>Generally the usable capacity will not be as high as that advertised by the battery manufacturer. Temperature and internal resistance of the battery are not taken into account in the guide.</p>
Sensor mA from 5V Excitation	<p>This is the current drawn by the sensor; this should be set to 2 mA for the T24-WSS to provide a conservative battery life guide.</p>
Usage Per 24 Hour Period	<p>Enter the number of hours per 24 hour period that the module will be turned on and transmitting.</p>

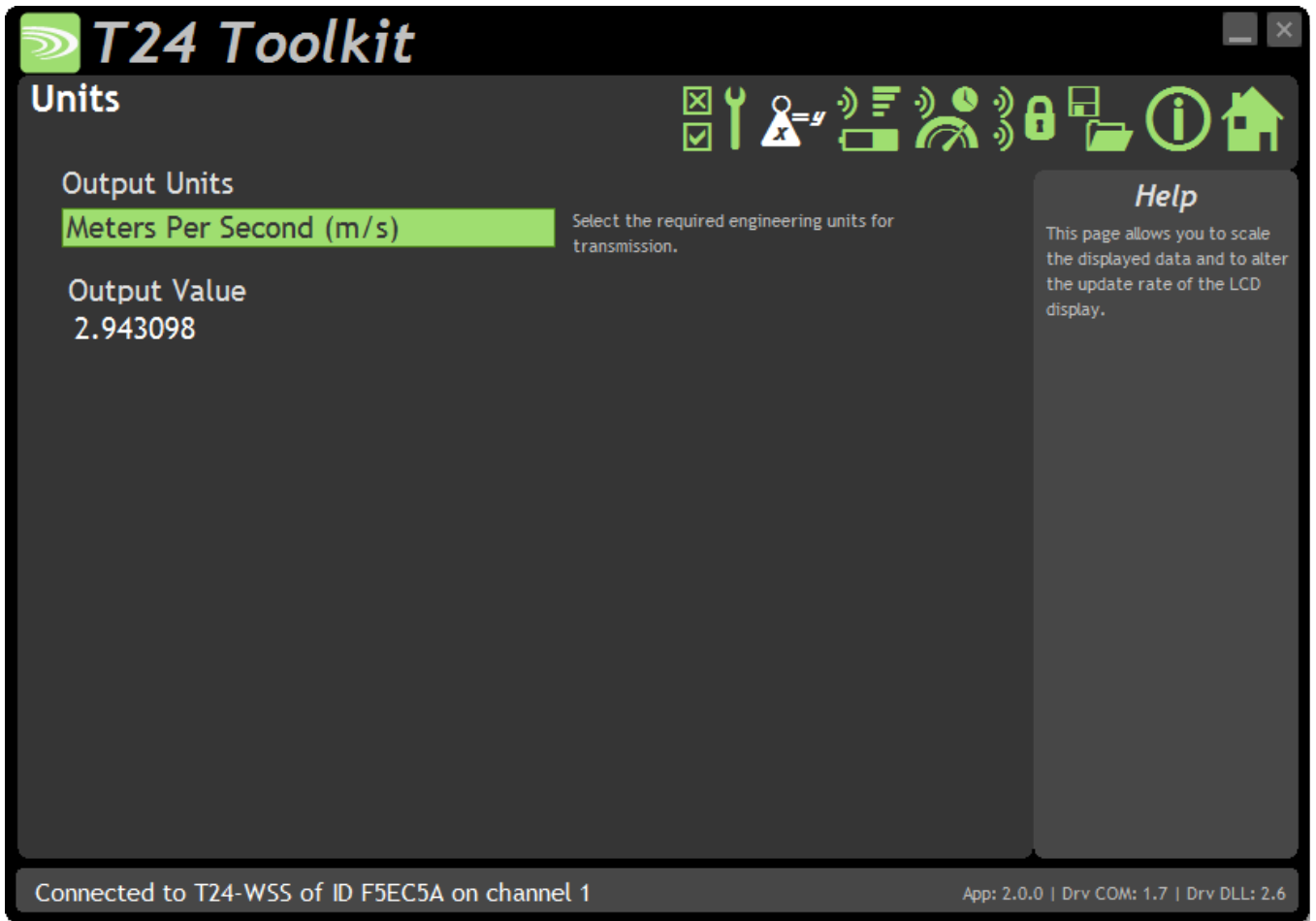

**Output Value** is the live value of the current wind speed in the units selected above.

**Items you can change:**

Output Units

Simply select the required output units from the drop down list. The T24-WSS can provide wind speed in m/s , mph, km/h and fps

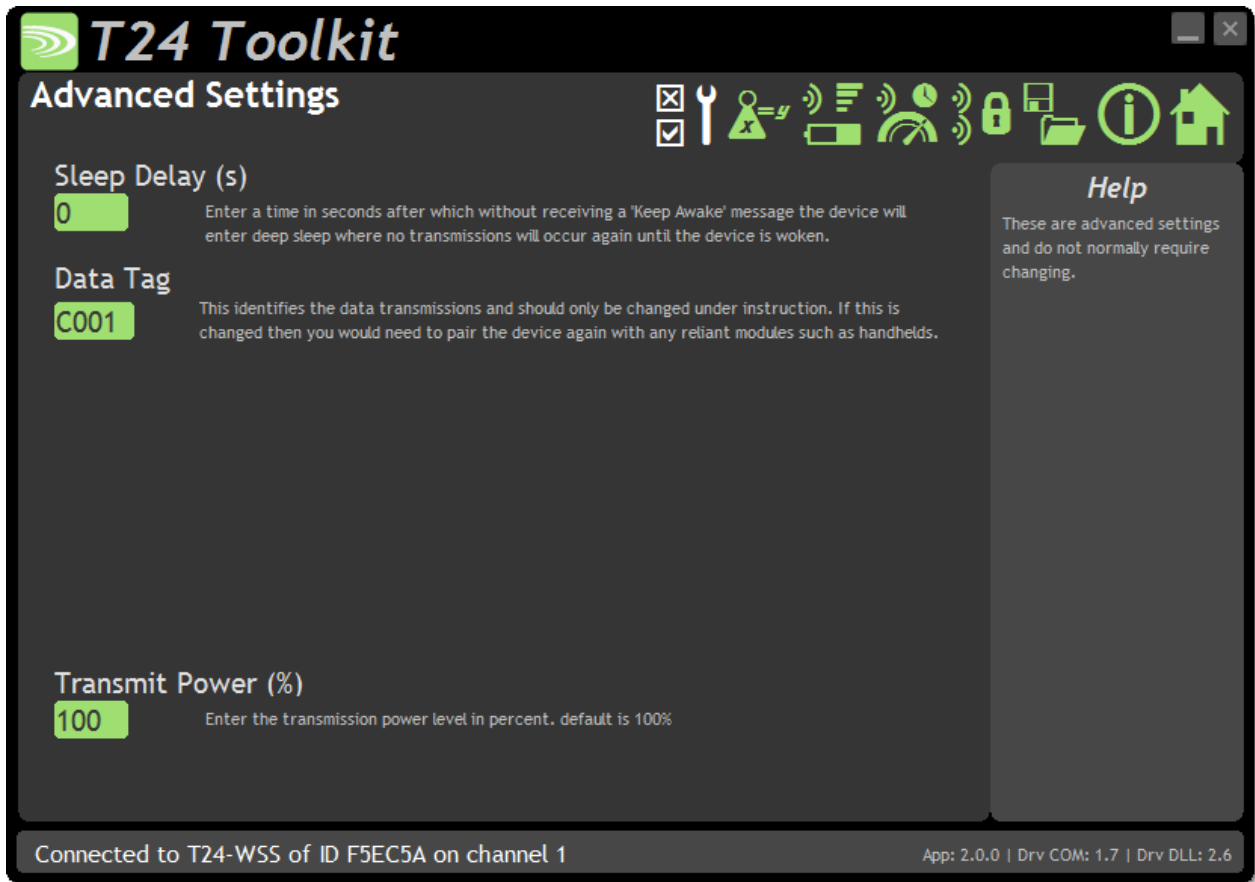

You should not normally need to change these settings.

**Items you can change:**

**Sleep Delay** Here you can enter a delay in seconds after which the transmitter module will return to deep sleep if no Keep Awake message is heard from software, handheld or other receiving modules. The default is 60 seconds.

**Data Tag** The data transmitted by the transmitter module is marked with a Data Tag which is a 2 byte hexadecimal code. By default this is set to the last 2 bytes of the module ID (or to put it another way, the last 4 characters of the module ID). If by some chance you had two transmitter module modules that would be working on the same channel and had the same last 4 characters in their ID (1 in 65,535 chances) you may want to change the data Tag of one of the modules and perform pairing again with the T24-HS handheld.

**Transmit power** Set the transmit power level from 0 – 100%. Default is 100%

---

## Enclosure & Mounting

The T24-WSS is designed to be attached to the top of a scaffold pole or equivalent using the fitted clamp.



---

## Antennas

These modules have the antenna already fitted inside the enclosure so there are no specific mounting requirements.

## Specification

Specification at 3V supply at 25°C

Parameter	Min	Typical	Max	Units
Measurement Range	5	-	125	mph
Accuracy 5 – 10 mph		0.5		mph
Accuracy 10 – 125 mph		±4%		mph

Environmental	Min	Typical	Max	Units
Operating Temperature Range	-20		+55	°C
Storage Temperature	-40		+85	°C
Humidity	0		95	%RH
Environmental protection with suitable cables exiting through cable glands.		IP67		

Power Supply	Min	Typical	Max	Units
Standby / Low Power Mode		5	20	µA
Normal Mode on constantly		55	60	mA
Reverse Polarity Protection		-	-32	Vdc
<b>Internal</b>				
Battery Supply Voltage	2.1	3	3.6	Vdc
Current		60	65	mA (1)
<b>External</b>				
Power Supply voltage	5		18	Vdc
Power Supply ripple			50	mV ac pk-pk
Current		60	65	mA (1)

1. Power supply must be capable of supplying 300 mA for 250 µs

Battery Life in Low Power Mode Generating Results every 2 seconds	Usage	Battery Life
Pair D cells	Constantly on	14 days
Pair D cells	12 sessions per day of 5 minutes	1 year

## Radio Range

To determine radio range please refer to [Appendix B – Antenna Range](#)

---

## Receiver Modules

Receiver modules use the messages sent by the transmitter modules. These modules may process or display this information or convert the data into a different physical format.

---

### T24-HS

---

#### Overview

The T24-HS is a simple handheld display. This allows wireless remote viewing of various remote inputs such as strain gauge or voltage etc. using 2.4GHz radio.

The remote transmitter module measures its input value (strain gauge, voltage, current etc.) and periodically transmits it.

The T24-HS captures this data and displays it. The T24-HS also performs the function of waking the transmitter module when it is turned on and sending it to deep sleep mode when it is turned off. The transmitter module will automatically enter deep sleep mode after 1 minute (default) if a T24-HS is not present.

If no buttons are pressed on the T24-HS it too will turn off after 5 minutes.

---

#### Order Codes

---

##### T24-HS



Handheld display for use with a single transmitter module in a robust weatherproof enclosure.

---

#### Connections

---

##### Power

The handheld module is powered by two alkaline AA batteries.

For battery information please refer to [Appendix D – Battery Selection](#)



*Due to the higher voltage requirements of this module NiMh and NiCad batteries are not recommended.*

---

## Quick Start

This section will show you how to get the module pair working out of the box. You will require two AA alkaline batteries for the handheld and a 3 Volt dc supply for the transmitter module which may also be a pair of AA batteries.

---

## Connecting Power

### T24-HS

Remove the two screws on the rear battery compartment. Insert two alkaline AA batteries. Refit the battery compartment cover. The handheld module is now switched on so should be turned off until the transmitter module is ready. To turn off just hold down the power key until the display shows **BUSY** then release it.

---

### Transmitter Module

See the relevant transmitter module manual section for information about connecting power.

---

## Pairing

You will use automatic pairing to prove the connectivity and operation. Pairing sets the communications configuration parameters to allow the two modules to communicate. You do not need a PC or laptop or any configuration software to perform basic pairing.

- Ensure that transmitter module is not powered.
- You need to turn on the T24-HS in pairing mode. To do this you start with it turned off. Whilst pressing the power key press the tare key as well until 'PAIRING' is seen on the display. The keys can now be released.
- Now apply power to the transmitter module within 10 seconds.
- If successful the T24-HS will pair to the transmitter module and the display will show a numeric value. (Or **Error 2** if the input integrity has failed. For example if the transmitter module is a T24-SA and the strain gauge is not connected).

If the display shows **Failed** or ----- then the pairing failed. Try again.

Once successful the T24-HS will be linked to the transmitter module and will send it to sleep when the handheld is turned off and wake it when the handheld is turned on.

Remember that from this point onwards to turn the handheld on you just need to press and hold the power key as the pairing function is no longer required. Pairing was just used as a method of setting the transmitter module to the radio settings already configured in the handheld.



---

## Operation

---

### Keys



**Power Key** - Press and hold the power key until the display shows BUSY then release the key.

Can also be used, by giving a quick press, to reset the Auto-Sleep delay.



**Tare Key** - This will toggle between gross and zeroed net mode. i.e. If the display shows gross then pressing the key will zero the display. Pressing the key when in net mode will return the display to gross mode. The Gross and Net modes are indicated as described below. Gross and Net are retained through power off.

---

### Modes

#### Pairing

When you want to use the T24-HS with a different transmitter module you use pairing. (Ensure that the transmitter module is unpowered for at least 10 seconds.) Press and hold the Power key then while still holding down the power key press and hold the Tare key.

Hold both keys until you see PAIRING on the display.

Release the keys and apply power to the transmitter module.



*When pairing, the channel and group key settings on the transmitter module are changed to match those on the T24-HS.*

---

### Indicators

#### G

The display is showing Gross weight.

#### NET

The display is showing Net weight.

#### SIG LOW

The radio signal from the transmitter module is low. The module is still functioning but the limit of the range may be near. Communications may start to deteriorate when this indicator is visible. Until ----- is displayed the communications are still OK and the display can be relied on for accuracy.



*Even with a degraded signal the display value will always be correct.*

#### BATT LOW

The batteries in the handheld are low and need to be replaced.

#### REMOTE ERROR

The transmitter module has an error that the handheld does not recognise.

#### REMOTE BATT LOW

The battery or supply to the transmitter module is low.

---

### Errors

Displayed on handheld LCD.

**Error 1**

The transmitter module has a strain gauge input and is in shunt calibration mode. An external module has placed the transmitter module in Shunt Calibration mode so rather than display a misleading reading this error is displayed instead. Modules such as the T24-SA support this error type.

**Error 2**

Input integrity error. The transmitter module has found a problem with the input. There may be open or short circuits. Rather than display a misleading reading this error is displayed instead. Only certain transmitter modules support this error such as the T24-SA.

**Overload**

The overload limit set by the user has been exceeded.

---

## Configuration

The T24 Toolkit provides a means of simple configuration of the handheld module along with useful tools to aid integration.

Launch the T24 Toolkit software application and pair to this module to enable the connection to the Toolkit to allow configuration to take place. [See Common Toolkit Pages - Home](#)



Here you can adjust settings that affect the display of zero.

### Items you can change:

#### Power On Auto Zero

Here you can determine whether the T24-HS performs automatic zero when it is powered on.

Enter zero to disable this function.

If you enter a non-zero value then when the handheld is first turned on it checks the value read from the transmitter module. If this falls within  $\pm$  of this value then the display will be altered so this reads zero.

**Example:** A strain gauge transmitter module (T24-SA) is calibrated in kg and measures the weight of boxes on a platform. The weight of the platform itself has been removed using system zero on the transmitter module.

Sometimes there is debris on the platform which you do not want to see when viewing the weight of boxes that will be placed on the platform later.

The minimum weight of a box is 5 kg so you could set the Power On Auto Zero to 2 kg.

When you turn on the handheld, if the weight on the platform is between -2 and +2kg then the handheld will tare this weight off and so read zero.

## Zero Indication Band

Using this setting you can mask tiny changes in input after you press the Tare button.

Entering zero will disable this function.

Entering a non-zero value will provide a band within which the display will always read zero.

Once the reading exceeds this value the real weight will be displayed as no taring is taking place.

**Example:** You are adding boxes to a platform and you press tare between adding each one so you can see the weight of each box.

Without this setting activated each time you tare the display will be around zero but not exactly zero (By setting the display resolution you may hide this difference) by setting a small value here such as 0.2kg the display will show a stable zero while actual weight is fluctuating less than  $\pm 0.2\text{kg}$ .

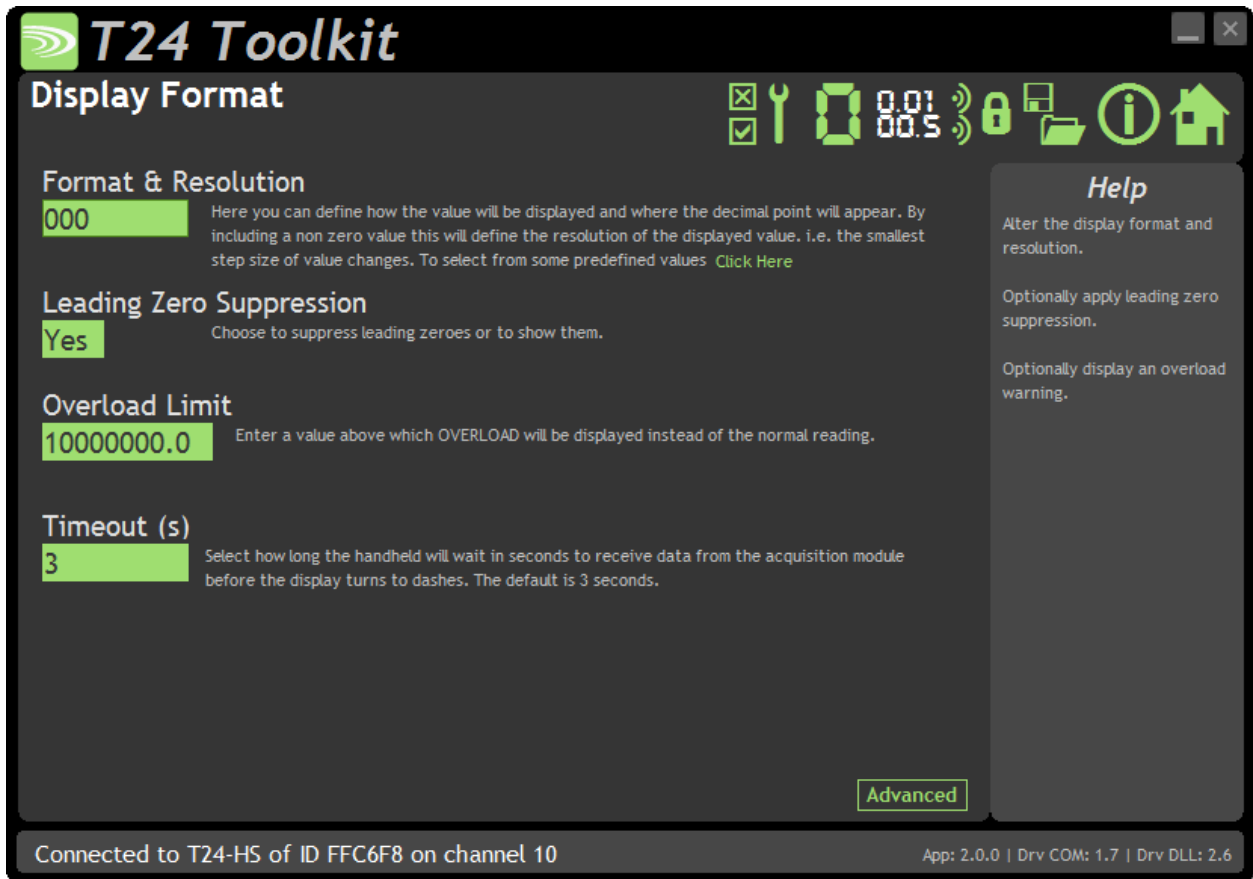

Here you can adjust the display.

**Items you can change:**

**Format & Resolution** Here you can define how the values are displayed on the LCD. There are 7 digits available and you can define where the decimal point is shown by entering numerals where a zero indicates a numeric digit position. When the data is being displayed the number of decimal places you define may be overridden as the display will always show the correct number of integer digits. Example: If you set the format to 000.0000 and the value to display is 1000.1234 the display will show 1000.123 You can also define the resolution, which is the block size of changes to the display. Example: If you enter the format as 000.0005 the display will only change in steps of 0.0005 which can be used to mask noisy digits at high resolutions.

**Leading Zero Suppression** This can be turned on or off and will suppress leading zeroes when on. Example: Leading zero suppression off gives a reading of 000.123 Leading zero suppression on gives a reading of 0.123

**Overload Limit** You can enter a limit here above which '**Overload**' will be shown on the display instead of the actual value. Applies to the gross input value including any custom scaling. Enter zero to disable this feature.

**Timeout** Enter the timeout in seconds. This sets the time allowed without any data arriving from the viewed module before '-----' is displayed on the LCD. Should be at least 3 times the interval between the data being transmitted by the transmitter module.

**Advanced** This opens the advanced page where you can scale the displayed data.



Here you can adjust the display update rate and also scale the displayed data. This may be used, for example, to convert the data from a T24-SA calibrated in kg so that the handheld display shows lb.

### Items you can change:

- |                        |  |
|------------------------|--|
| Display Update Rate    | Enter the interval in milliseconds between display updates. The default is 300 milliseconds. i.e. 3 updates per second.  |
| Custom Display Scaling | This can be used to change the displayed value to a different unit or to otherwise scale it. You simply enter the original and required values at a low and high point. Example: If a T24-SA was supplying data in kg and you wanted to show tonnes. You would keep both the low points at zero. Enter <b>At High Input Value</b> of 1000 and <b>Display Should Read</b> Value of 1. |



You should not normally need to change these settings.

**Items you can change:**

- Waker Duration**                      When the handheld is turned on it will attempt to wake the paired transmitter module if **Do Sleep Wake** is activated. This setting allows you to adjust the time it will wait to wake the remote module in milliseconds. The default is 12000.
- Do Sleep Wake**                      You can select whether the handheld wakes the remote transmitter module on power up and sends it to sleep on power down. Select No to disable this function. The default is Yes.
- Auto Off Delay**                      Here you can specify the delay in minutes after which the handheld will automatically turn off after no button is pressed. Enter zero to disable this function. The default is 5 minutes.
- Keep Awake Interval**                While the handheld is receiving messages from the transmitter module it periodically sends out a **Keep Awake** message. This will stop the transmitter module from going to sleep while the handheld is in use. The default is 5 seconds.
- Pair Wait Duration**                   Here you can set the duration that the handheld will wait to achieve successful pairing when it is turned on in Pairing mode. The default is 5 seconds.

**Decode Binary Data Provider (versions 1.06 onwards)**

- Start Byte**                              When the handheld is used with a module that transmits a binary data provider packet the following two parameters are required to describe how the handheld should extract a single value to display. The start byte (zero based) specifies where in the data provider data to start decoding.



## Data Type

Specify the data type to extract. The choices are UINT8, UINT16, INT32 or FLOAT. You would need to refer to the programmers manual of the appropriate transmitter module to work out where to extract data from and what type. The default of INT32 with a Start Byte of zero is the default which will be correct for a T24-SAF module.

---

## Enclosure & Mounting

See [Appendix A – Handheld Style](#) section for more information.

---

## Antennas

These modules have the antenna already fitted inside the enclosure so there are no specific mounting requirements.

---

## Specification

<b>Electrical</b>	<b>Min</b>	<b>Typical</b>	<b>Max</b>	<b>Units</b>
Power Supply voltage	2.5	3.0	3.6	Vdc

<b>Power Supply</b>	<b>Min</b>	<b>Typical</b>	<b>Max</b>	<b>Units</b>
Active		35	40	mA
Low power mode		120	160	µA
Estimated Battery life using 2Ahr batteries:				
Standby mode (Powered off)		1.5		Years
Continuous operation		35		Hours

<b>Environmental</b>	<b>Min</b>	<b>Typical</b>	<b>Max</b>	<b>Units</b>
IP rating		IP67		
Operating Temperature Range	-10		+50	C
Storage Temperature	-40		+85	C
Humidity	0		95	%RH

<b>Physical</b>	
Hand Held Dimensions	90 mm x 152 mm x 34 mm

---

## Radio Range

To determine radio range please refer to [Appendix B – Antenna Range](#)

---

## T24-HA

---

### Overview

The T24-HA is an advanced handheld display. This allows wireless remote viewing of multiple inputs such as strain gauge or voltage etc. using 2.4GHz radio.

The T24-HA also performs the function of optionally waking the remote modules when it is turned on and sending them to deep sleep mode when it is turned off.

The handheld can operate in two modes. The operation of the buttons and the automatic sleep/wake functions are dependent on these modes.

#### **Result Mode**

This is the default mode in which multiple transmitter modules are used to create a result which is displayed. Currently the T24-HA only provides a **sum** of the remote modules but this function may be added to in future versions. Although the handheld usually shows the result (sum) there is an option of viewing the discrete values that make up the result.

#### **Item Mode**

In this mode each transmitter module is treated as a separate reading and the handheld is used to cycle through the available items and the value of each can be viewed.

---

### Order Codes

---

#### T24-HA



Handheld display for use with multiple transmitters and with advanced functionality.

---

### Connections

---

#### Power

The handheld module is powered by two alkaline AA batteries.

For battery information please refer to [Appendix D – Battery Selection](#)



*Due to the higher voltage requirements of this module NiMh and NiCad batteries are not recommended.*

---

## Operation

The handheld can operate in two modes and the button operation is dependent on these modes.

---

### Item Mode

Up to 12 individual modules can be connected to and the user can step through each one in sequence. If DoSleepWake is set then the handheld will wake transmitters when turned on and send them all to sleep again when turned off. When the handheld wakes modules this is achieved through the transmission of a broadcast wake. i.e. all modules on the same channel and with the same group key will wake.

---

### Keys



**Sleep key** - Send the currently selected module to sleep.

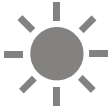

**Wake Key** - Will attempt to wake the currently selected module.



**Tare Key** - This will toggle between gross and zeroed net mode. i.e. If the display shows gross then pressing the key will zero the display. Pressing the key when in net mode will return the display to gross mode. The Gross and Net modes are indicated as described below. Gross and Net are retained through power off.



**Next Key** - Step to the next module. A brief prompt will be displayed before the value is shown. i.e. 'Input 1', 'Input 2' etc. Also see [Prompts](#)



If motion detection is activated then the reading must be steady to enable this key. Pressing this key with an unstable reading will do nothing.

**Function Key** - This transmits a Data Provider packet marked with a Data Tag held in **F1DataTag** and can also contain data as defined by **F1Data**. This can be used to trigger external actions such as a printout.



**Power Key** - Press and hold the power key until the display shows BUSY then release the key. Can also be used, by giving a quick press, to reset the Auto-Sleep delay.

---

## Result Mode

Up to 12 individual modules can be summed and the result displayed.

If **DoSleepWake** is set then the handheld will wake all modules when turned on and send them to sleep again when turned off. When the handheld wakes modules this is achieved through the transmission of a broadcast wake. i.e. all modules on the same channel and with the same group key will wake.

In this mode there is an option of retrieving a system zero value from an external source. This is activated by supplying the Data Tag to the **ExtZeroDataTag** parameter. When activated the value supplied by the Data Provider packet marked with this tag will be used as the system zero and will be subtracted from the sum of all contributing inputs.

Usually in this mode only the result is displayed (sum) but holding the **Next** key for a configurable number of seconds will activate the ability to step through each contributing input using the **Next** key.

---

### Keys when viewing Result



**Sleep Key** - No effect.

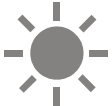

**Wake Key** - Will attempt to wake any sleeping modules.

This uses a broadcast wake so any modules on the same channel with the same group key will wake.



**Tare Key** - Toggle between displaying gross sum or tared sum.



**Next Key** - No effect unless held for a number of seconds to activate individual item view.

This can be disabled. See [Allow Next Key](#)

Newer versions also allow customised prompt messages to replace the default 'Input 1', 'Input 2' etc. See [Prompts](#)



**Function Key** - If motion detection is activated then the reading must be steady to enable this key. Pressing this key with an unstable reading will do nothing.

This transmits a Data Provider packet marked with a Data Tag held in **F1 DataTag** and can also contain data as defined by **F1 Data** ( See [Mode and Communications](#) later ). This can be used to trigger external actions such as a printout or a relay operation. This would require suitable relay or printer T24 modules.



**Power Key** - Toggles between on and off. Hold for 2 seconds to activate.

---

### Keys when viewing an individual item



**Sleep Key** - No effect.

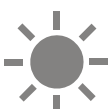

**Wake Key** - Will attempt to wake the currently selected module.



**Tare Key** - If sum was currently tared then this key will toggle between displaying gross or tared value of current module. If sum view was displaying gross then this key has no effect. If an external system zero is used then only gross values actually supplied to the handheld can be displayed.



**Next Key** - Selects next input item to view.



**Function Key** - If motion detection ( See settings in [Display Format](#) later ) is activated then the reading must be steady to enable this key. Pressing this key with an unstable reading will do nothing.

This transmits a Data Provider packet marked with a Data Tag held in **F1DataTag** and can also contain data as defined by **F1Data**. This can be used to trigger external actions such as a printout.



**Power Key** - Toggles between on and off. Hold for 2 seconds to activate.

---

## All Modes

---

### Indicators

<b>G</b>	The display is showing Gross weight.
<b>NET</b>	The display is showing Net weight.
<b>SIG LOW</b>	The radio signal from the transmitter module is low. The module is still functioning but the limit of the range may be near. Communications may start to deteriorate when this indicator is visible. Until ----- is displayed the communications is still OK and the display can be relied on for accuracy.



*Even with a degraded signal the display value will always be correct.*

<b>BATT LOW</b>	The batteries in the handheld are low and need to be replaced.
<b>REMOTE ERROR</b>	The transmitter module has an error that the handheld does not recognise.
<b>REMOTE BATT LOW</b>	The battery or supply to the transmitter module is low.

---

### Errors

Displayed on handheld LCD.

<b>Error 1</b>	The transmitter module has a strain gauge input and is in shunt calibration mode. An external module has placed the transmitter module in Shunt Calibration mode so rather than display a misleading reading this error is displayed instead. Modules such as the T24-SA support this error type.
<b>Error 2</b>	Input integrity error. The transmitter module has found a problem with the input. There may be open or short circuits. Rather than display a misleading reading this error is displayed instead. Only certain transmitter modules support this error such as the T24-SA.
<b>Overload</b>	The overload limit set by the user has been exceeded.
<b>{Display Flashing}</b>	The motion detection has been enabled and the reading is deemed in motion or unstable.

---

### Other Functions

<b>System Zero</b>	If enabled, holding the Tare key for a number of seconds will perform a system zero.
<b>Pairing</b>	See Field Transmitter Module Replacement later



## Configuration

The T24 Toolkit provides a means of simple configuration of the handheld module along with useful tools to aid integration.

Launch the T24 Toolkit software application and pair to this module to enable the connection to the Toolkit to allow configuration to take place. [See Common Toolkit Pages - Home](#)

## Mode and Communications

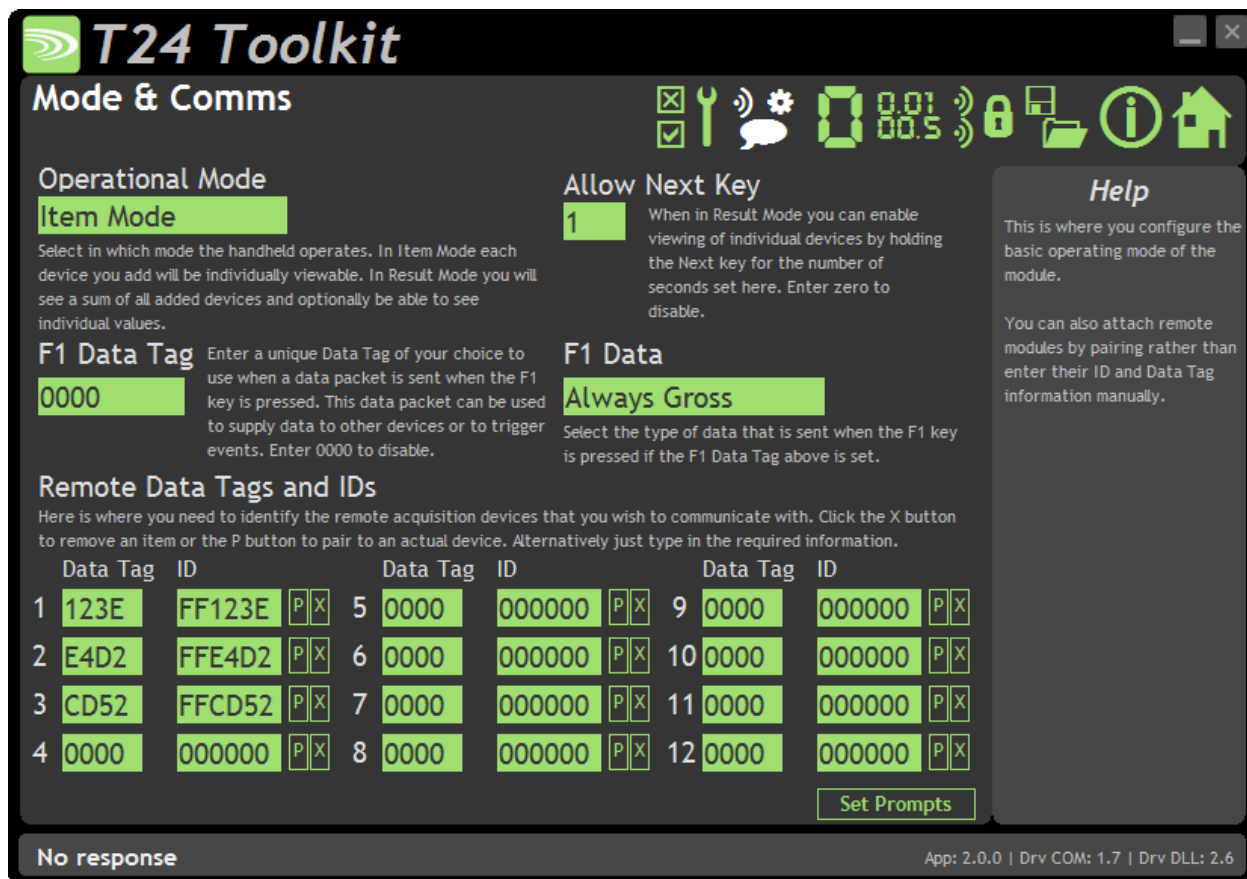

This page allows you to set the operational mode of the module and configure which external transmitter modules the handheld will connect to.

### Items you can change:

**Operational Mode** Select in which mode the handheld will operate.

#### **Result Mode**

Up to 12 individual transmitter modules can be summed and displayed. Optionally the operator can view the individual module values (See Allow Next Key).

#### **Item Mode**

Up to 12 individual modules can be displayed and the user can step through each one in sequence.

**Allow Next Key** Only used in Result Mode. Usually in Result mode only the result (sum) of the individual modules is shown. By entering a non-zero value here this will define the number of seconds that the **Next** key needs to be held down to enable individual item values to be viewed. Once available the **Next** key will cycle between all the individual values and the result. This will remain available until the handheld is powered off. Each time the **Next** key is pressed the display will show a brief message indicating what will be displayed; **Input 1**, **Input 2**, **Result** etc. From firmware version 1.2 onwards the handheld allow customised prompt messages. See [Prompts](#)

**F1 Data Tag** The **F1** key can be used to trigger other modules such as a T24-SO module to provide printer services etc. This key will generate a Data Provider message which other modules can use. Set this value to non zero to enable this function and to define the Data Tag that will identify the message sent. The content of the message is defined by the **F1 Data** parameter.

 *If motion detection is configured then this key will have no effect while the reading is not steady.*

**F1 Data** Define what data is carried in the Data Provider message when the **F1** key is pressed. Select **Always Gross** to transmit the gross value regardless of whether the Tare key has been pressed. Select **As Displayed** to transmit either the gross or net value depending on the currently displayed data.

### Remote Data Tags and IDs

**Data Tag** Enter the Data Tag of the message to use for the specified input item.

**ID** Enter the ID of the module used to supply the specified input item.

 *This is only necessary for **Item Mode** where individual items are to be woken using the **Wake** key as opposed to letting the handheld wake all modules.*

If you are not using Item mode then you are not required to enter the ID although it will be filled in automatically if you pair to a module to retrieve its settings.

**P** Click this then perform pairing on a remote transmitter to automatically provide the ID and Data Tag. Usually pairing is activated by removing and replacing the power supply on the remote transmitter. You must perform pairing within 5 seconds of clicking the button.

**X** Click this to reset the Data Tag and ID to zero (disabling the input item).

**Set Prompts** For modules with a firmware revision of 1.2 and newer this button will be visible. This displays a page where the message labels shown before switching between channels can be set by the user.

## Prompts

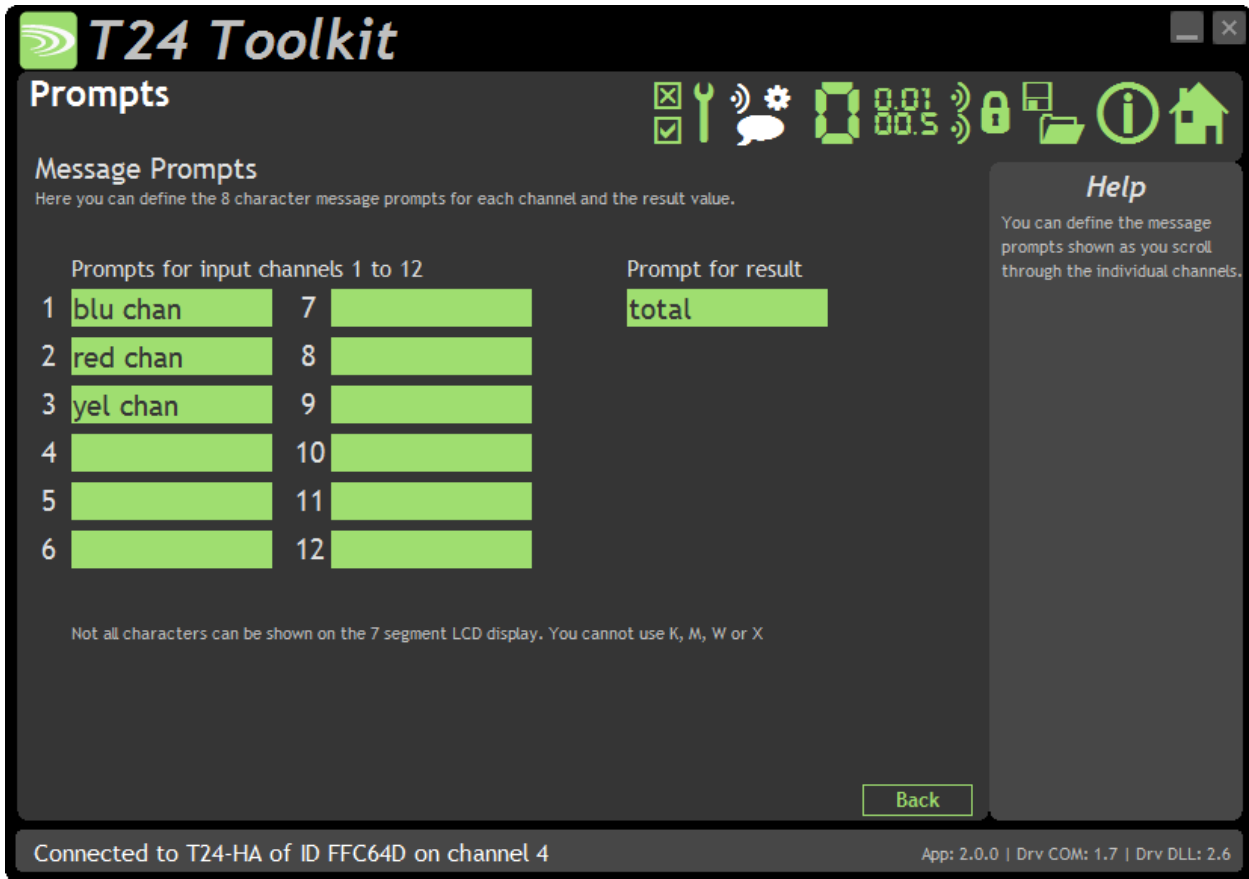

Here you can adjust the messages shown when switching between input channels in Item Mode..

### Items you can change:

Prompts 1 to 12

These prompts are briefly shown when switching between inputs. They default to 'input 1', 'input 2' etc

Leave the prompt blank to display the Data Tag of the module supplying data to the current item.



*The displayed prompts are limited to 8 characters and be aware that the 7 segment LCD display is very limited in how it can represent letters. Some letters cannot be displayed. These include K, M, W, X*

Prompt for result

Enter the prompt to display before the total result is displayed.



Here you can adjust settings that affect the display of zero.

#### Items you can change:

##### Power On Auto Zero

Here you can determine whether the T24-HA performs automatic zero when it is powered on.

Enter zero to disable this function.

If you enter a non-zero value then when the handheld is first turned on it checks the value read from the transmitter module. If this falls within  $\pm$  of this value then the display will be altered so this reads zero.

**Example:** A strain gauge transmitter module (T24-SA) is calibrated in kg and measures the weight of boxes on a platform. The weight of the platform itself has been removed using system zero on the transmitter module.

Sometimes there is debris on the platform which you do not want to see when viewing the weight of boxes that will be placed on the platform later.

The minimum weight of a box is 5 kg so you could set the Power On Auto Zero to 2 kg.

When you turn on the handheld, if the weight on the platform is between -2 and +2kg then the handheld will tare this weight off and so read zero.

Zero Indication Band	<p>Using this setting you can mask tiny changes in input after you press the Tare button.</p> <p>Entering zero will disable this function.</p> <p>Entering a non-zero value will provide a band within which the display will always read zero.</p> <p>Once the reading exceeds this value the real weight will be displayed as no taring is taking place.</p> <p><b>Example:</b> You are adding boxes to a platform and you press tare between adding each one so you can see the weight of each box.</p> <p>Without this setting activated each time you tare the display will be around zero but not exactly zero (By setting the display resolution you may hide this difference) by setting a small value here such as 0.2kg the display will show a stable zero while actual weight is fluctuating less than <math>\pm 0.2\text{kg}</math>.</p>
Allow System Zero	<p>Entering a non-zero value here will enable system zero to be performed by holding down the Tare key for a number of seconds.</p> <p>The value entered here represents the number of seconds the Tare key needs to be held.</p>
Perform System Zero	<p>This section allows the user to apply or remove a system zero.</p> <p>This will require that the transmitter modules are configured and attached to the handheld and the entire system is ready for zeroing.</p>



This advanced section allows the use of a specially configured external module to supply the system zero value for the handheld to use.

**Example:**

The same handheld is used with a truck that picks up different trailers and is required to display the sum of 4 strain gauges connected to each trailer (Using T24-SAs). Because each trailer will have a different system zero requirement you would add a further module to each trailer set to transmit the system zero value. It is the Data Tag that is entered here.

On all trailers the transmitter module sets would share the same Data Tags.

**Items you can change:**

- Data Tag    Enter the **Data Tag** of the message to use for the external system zero.
  
- ID            Contains the ID of the module used to supply the external system zero. This is only necessary to provide a visible record of the remote module and is shown to keep compatibility with the **Mode and Communications** page.  
You do not need to enter anything here although it will be filled in automatically if you perform a pair to retrieve data.
  
- P            Click this then perform pairing on a remote transmitter to automatically provide the ID and Data Tag. Usually pairing is activated by removing and replacing the power supply on the remote transmitter. You must perform pairing within 5 seconds of clicking the button.
  
- X            Click this to reset the Data Tag and ID to zero (disabling the external system zero function).

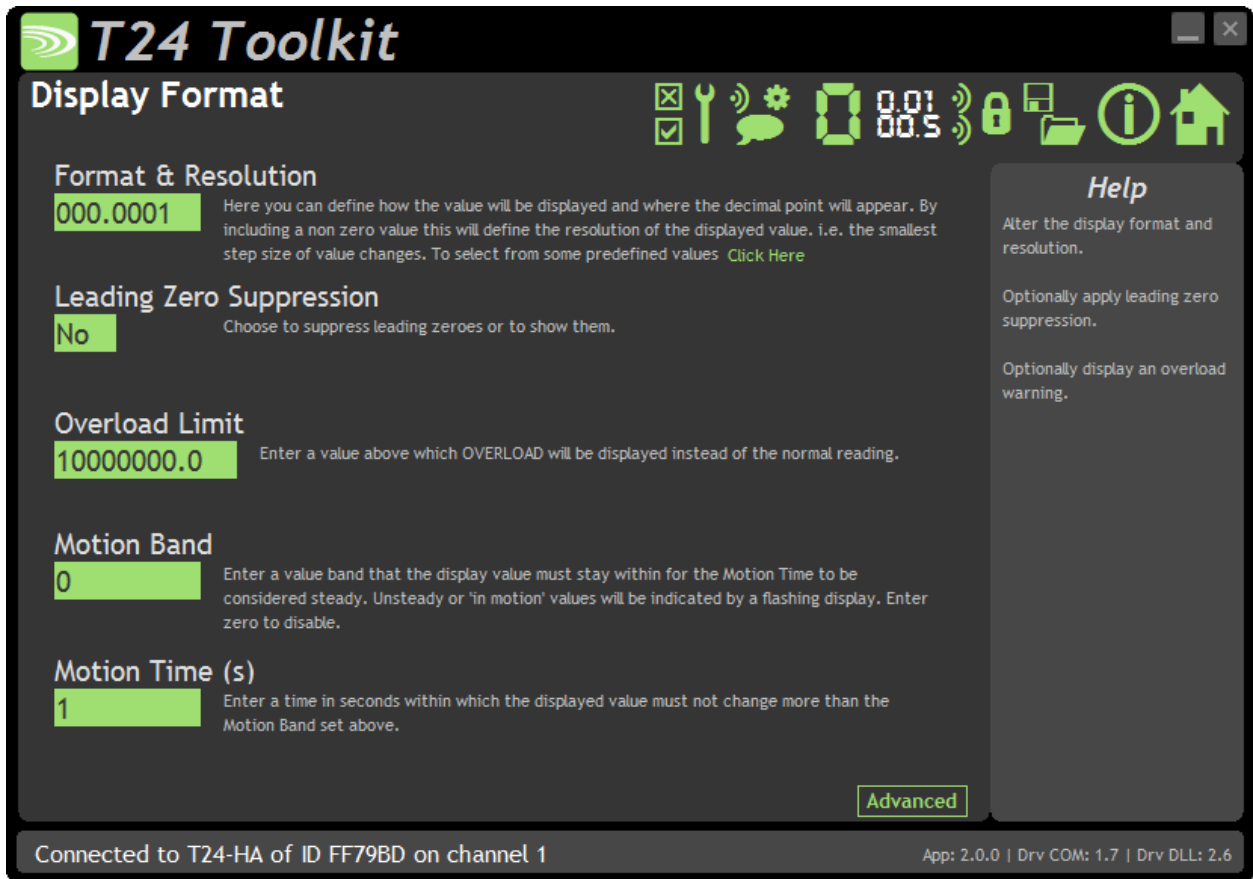

Here you can adjust the display.

**Items you can change:**

- Format & Resolution**      Here you can define how the values are displayed on the LCD. There are 7 digits available and you can define where the decimal point is shown by entering numerals where a zero indicates a numeric digit position.

When the data is being displayed the number of decimal places you define may be overridden as the display will always show the correct number of integer digits.

Example: If you set the format to 000.0000 and the value to display is 1000.1234 the display will show 1000.123

You can also define the resolution, which is the block size of changes to the display.

Example: If you enter the format as 000.0005 the display will only change in steps of 0.0005 which can be used to mask noisy digits at high resolutions.
- Leading Zero Suppression**      This can be turned on or off and will suppress leading zeroes when on.  
 Example: If the display reads 000.123 with leading zero suppression turned off it will display 0.123 when leading zero suppression is turned on.
- Overload Limit**      You can enter a limit here above which **Overload** will be shown on the display instead of the actual value.  
 Enter zero to disable this feature.
- Advanced**      This opens the advanced page where you can scale the displayed data.

Motion Band

By entering a non-zero value here you activate the motion detection. If, within the Motion Time, the displayed value changes by more than the amount entered the reading will be deemed in motion or unstable and the display will flash. The F1 key will be disabled while the reading is in motion.

Motion Time

Enter a time in seconds within which the displayed value must not change more than the Motion Band amount set above.





Here you can adjust the display update rate and also scale the displayed data. This may be used, for example, to convert the data from a T24-SA calibrated in kg so that the handheld display shows lb.

**Items you can change:**

- |                        |  |
|------------------------|--|
| Display Update Rate    | Enter the interval in milliseconds between display updates. The default is 300 milliseconds. i.e. approximately 3 updates per second.  |
| Custom Display Scaling | This can be used to change the displayed value to a different unit or to otherwise scale it. You simply enter the original and required values at a low and high point. Example: If a T24-SA was supplying data in kg and you wanted to show tonnes. You would keep both the low points at zero. Enter <b>At High Input Value</b> of 1000 and <b>Display Should Read</b> Value of 1. |

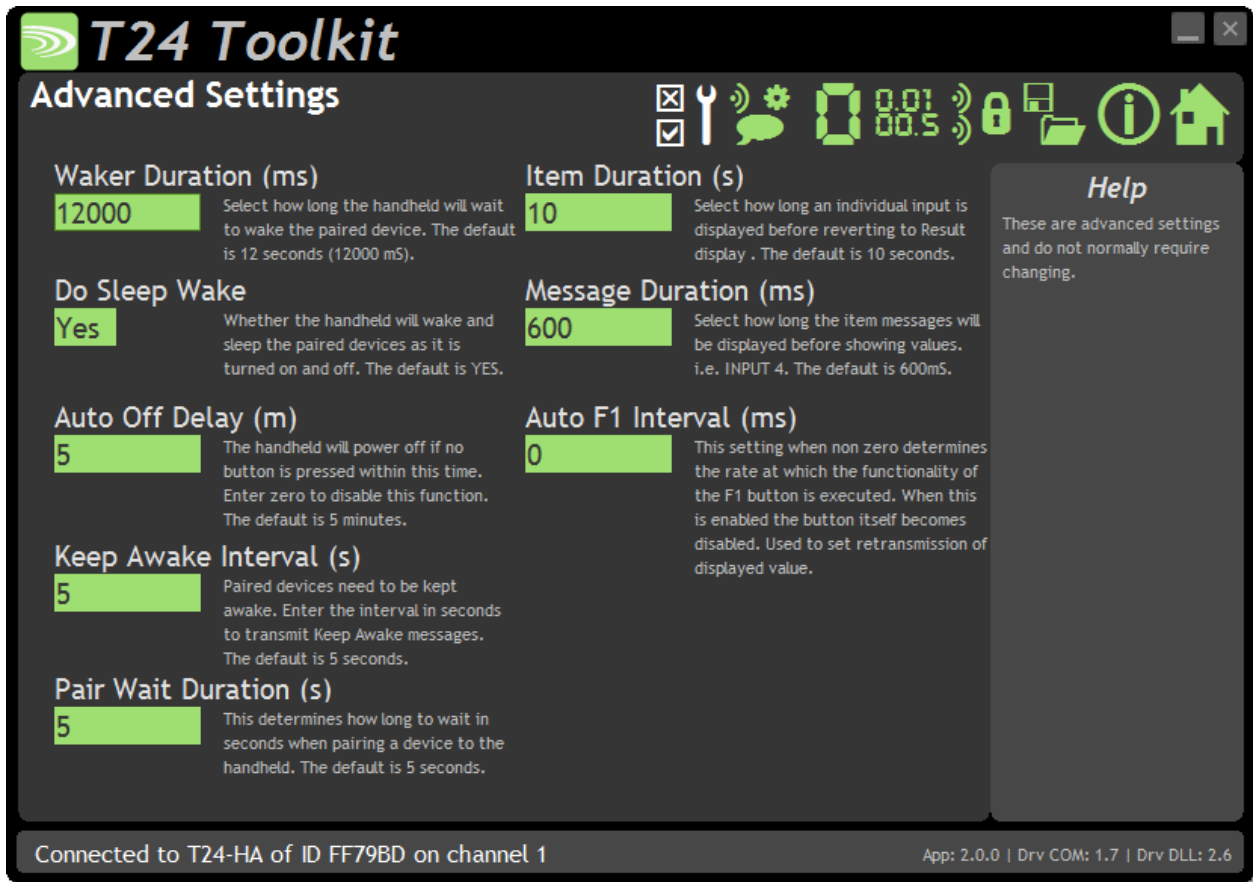

You should not normally need to change these settings.

**Items you can change:**

- Waker Duration**      When the handheld is turned on it may attempt to wake the paired transmitter modules. This setting allows you to adjust the time it will wait to wake the remote modules in milliseconds. The default is 12000.
- Do Sleep Wake**      You can select whether the handheld wakes the remote transmitter modules on power up and sends them to sleep on power down. Select No to disable this function. The default is Yes.
- Auto Off Delay**      Here you can specify the delay in minutes after which the handheld will automatically turn off after no button is pressed. Enter zero to disable this function. The default is 5 minutes.
- Keep Awake Interval**      While the handheld is retrieving data from the transmitter module it periodically sends out a **Keep Awake** packet. This will stop the transmitter module from going to sleep while the handheld is in use. The default is 5 seconds.
- Pair Wait Duration**      Here you can set the duration that the handheld will wait to achieve successful pairing when it is turned on in Pairing mode. The default is 5 seconds.
- Item Duration**      Used when in Result Mode and the Next key has been enabled to allow viewing of discrete inputs. Enter a time in seconds that the individual item value will be displayed for before the display is automatically switched back to showing the result.

## Message Duration

Each time the **Next** key is used to step through available items the display shows a brief description of the data about to be displayed. **Input 1, Input 2, Result** etc. The time you enter here in milliseconds is the time that this message will be displayed before the actual value is shown. Newer versions of the handheld allow the user to define these message prompts. See [Prompts](#)

---

## Enclosure & Mounting

See [Appendix A – Handheld Style](#) section for more information.

---

## Antennas

These modules have the antenna already fitted inside the enclosure so there are no specific mounting requirements.

---

## Specification

<b>Electrical</b>	<b>Min</b>	<b>Typical</b>	<b>Max</b>	<b>Units</b>
Power Supply voltage	2.5	3.0	3.6	Vdc

<b>Power Supply</b>	<b>Min</b>	<b>Typical</b>	<b>Max</b>	<b>Units</b>
Active		35	40	mA
Low power mode		120	160	µA
Estimated Battery life using 2Ahr batteries:				
Standby mode (Powered off)		1.5		Years
Continuous operation		35		Hours

<b>Environmental</b>	<b>Min</b>	<b>Typical</b>	<b>Max</b>	<b>Units</b>
IP rating		IP67		
Operating Temperature Range	-10		+50	C
Storage Temperature	-40		+85	C
Humidity	0		95	%RH

<b>Physical</b>	
Hand Held Dimensions	90 mm x 152 mm x 34 mm

---

## Radio Range

To determine radio range please refer to [Appendix B – Antenna Range](#)

---

## T24-HR

---

### Overview

The T24-HR is a roaming handheld that can be used to view the reading supplied by an unlimited number of transmitter modules. The transmitter module Data Tags or IDs do not need to be known beforehand.

The handheld will automatically wake any module on the same channel and group key.

An internal list is maintained of the top **n** number of transmitter modules ordered by signal level and a **Next** key on the handheld allows cycling through this list.

The list size (**n**) is user definable between 2 and 20 and this enables the viewing experience to be tailored to particular applications.

The transmitter modules are identified by their 4 character hexadecimal Data Tags and these may be set using the T24 Toolkit.

When in communication with a particular transmitter module the LED on that module is activated. This provides visual feedback of the selected and currently viewed module. The LED output can also appear optionally on the digital output.

---

### Order Codes

---

#### T24-HR



Handheld display for unlimited number of transmitter modules in a robust weatherproof enclosure.

---

### Connections

---

#### Power

The handheld module is powered by two alkaline AA batteries.

For battery information please refer to [Appendix D – Battery Selection](#)



*Due to the higher voltage requirements of this module NiMh and NiCad batteries are not recommended.*

---

## Operation

---

### View readings

As long as the transmitter module is on the same radio channel and share the same Group key settings as the handheld you will be able to view the reading once the handheld is turned on.

If you need to change the channel of the transmitter module you will need to use the T24 Toolkit software or see Pairing later in the manual.

Each time you press the Next key  the handheld will cycle to the next transmitter module in its list of detected modules. The Data Tag of the selected module will be displayed briefly before the reading is displayed.

To view the Data Tag of the currently viewed module press and hold the next key  for around a second and the Data Tag will be displayed and the reading will remain that of the current module without stepping on.

---

### Keys



**Power Key** - Press and hold the power key for approximately 2 seconds then release the key.

This will toggle between turning the handheld on and off.

Can also be used, by giving a quick press, to reset the Auto-Sleep delay.



**Next Key** – Pressing and releasing selects the next transmitter to view.

Pressing and holding will display the currently viewed transmitter Data Tag without moving to the next transmitter.

---

### Indicators

#### **SIG LOW**

The radio signal from the transmitter module is low. The module is still functioning but the limit of the range may be near. Communications may start to deteriorate when this indicator is visible. Until ----- is displayed the communications are still OK and the display can be relied on for accuracy.



*Even with a degraded signal the display value will always be correct.*

#### **BATT LOW**

The batteries in the handheld are low and need to be replaced.

#### **REMOTE ERROR**

The transmitter module has an error that the handheld does not recognise.

#### **REMOTE BATT LOW**

The battery or supply to the transmitter module is low.

---

## Errors

Displayed on handheld LCD.

- Error 1** The transmitter module has a strain gauge input and is in shunt calibration mode. An external module has placed the transmitter module in Shunt Calibration mode so rather than display a misleading reading this error is displayed instead. Modules such as the T24-SA support this error type.
- Error 2** Input integrity error. The transmitter module has found a problem with the input. There may be open or short circuits. Rather than display a misleading reading this error is displayed instead. Only certain transmitter modules support this error such as the T24-SA.
- Overload** The overload limit set by the user has been exceeded.

---

## Special Modes

T24-HR label actually has 6 keys but only 2 are marked. The following modes require some of the unmarked keys.

### Pair



The handheld has the ability to configure a transmitter module to match the handheld's own radio channel and group key settings. Ensure that the transmitter module is unpowered for at least 10 seconds. Locate the upper left key by feeling for a slight bump on the label.

Press and hold this key for 5 seconds until PAIRING appears on the LCD. Release the key and apply power to the transmitter module.

The amount of time you have to reapply power to the transmitter module can be set by **PairDuration** in the T24 Toolkit when connected to the T24-HR. This defaults to 5 seconds.

### System Zero



The handheld has the ability to perform a system zero on a remote transmitter module. This may be useful after installing new modules and enables system zero to be set without the need for a PC/laptop and T24 Toolkit.

Set the handheld to view the desired transmitter module by using the Next key.

Locate the upper right key and lower right key by feeling for slight bumps on the label.

Press and hold these keys for around 8 seconds until ZERO appears on the LCD. Release the keys and the display should then show the zeroed reading.

This system zero is performed at the transmitter module and is stored through power cycling.



---

## Transmitter Module Configuration

Unless the transmitter modules are permanently powered their Sleep Delay setting should be set to a non-zero value so that the module returns to deep sleep when the handheld is turned off or goes out of range. It is suggested that this time is set to **at least** 3 times the interval between its data transmissions but can be longer. i.e. If the default transmission rate is 333ms (3Hz) choose a Sleep Delay of around 5 seconds. This is a good battery saving time that will ensure the transmitter stays awake even if out of range of the handheld temporarily.

Most transmitter modules allow the LED state to be echoed to the digital output line which allows an external LED to be fitted. This is useful when requiring visual feedback of the module the handheld is currently viewing.

The handheld displays the data at the rate that the transmitter module is configured to supply. The ideal rate is about 3hz which is the default but the handheld will operate quite happily with modules with a data delivery rate of down to around 1 every 30 seconds. Just remember to set the Timeout of the handheld to at least 3 times this period. (i.e. 91 seconds in the case of 30 second transmission interval).



*The handheld will wake **any** sleeping module if it is on the same channel and has the same group key.*

---

## Configuration

The T24 Toolkit provides a means of simple configuration of the handheld module along with useful tools to aid integration.

Launch the T24 Toolkit software application and pair to this module to enable the connection to the Toolkit to allow configuration to take place. [See Common Toolkit Pages - Home](#)

---

### Display Format

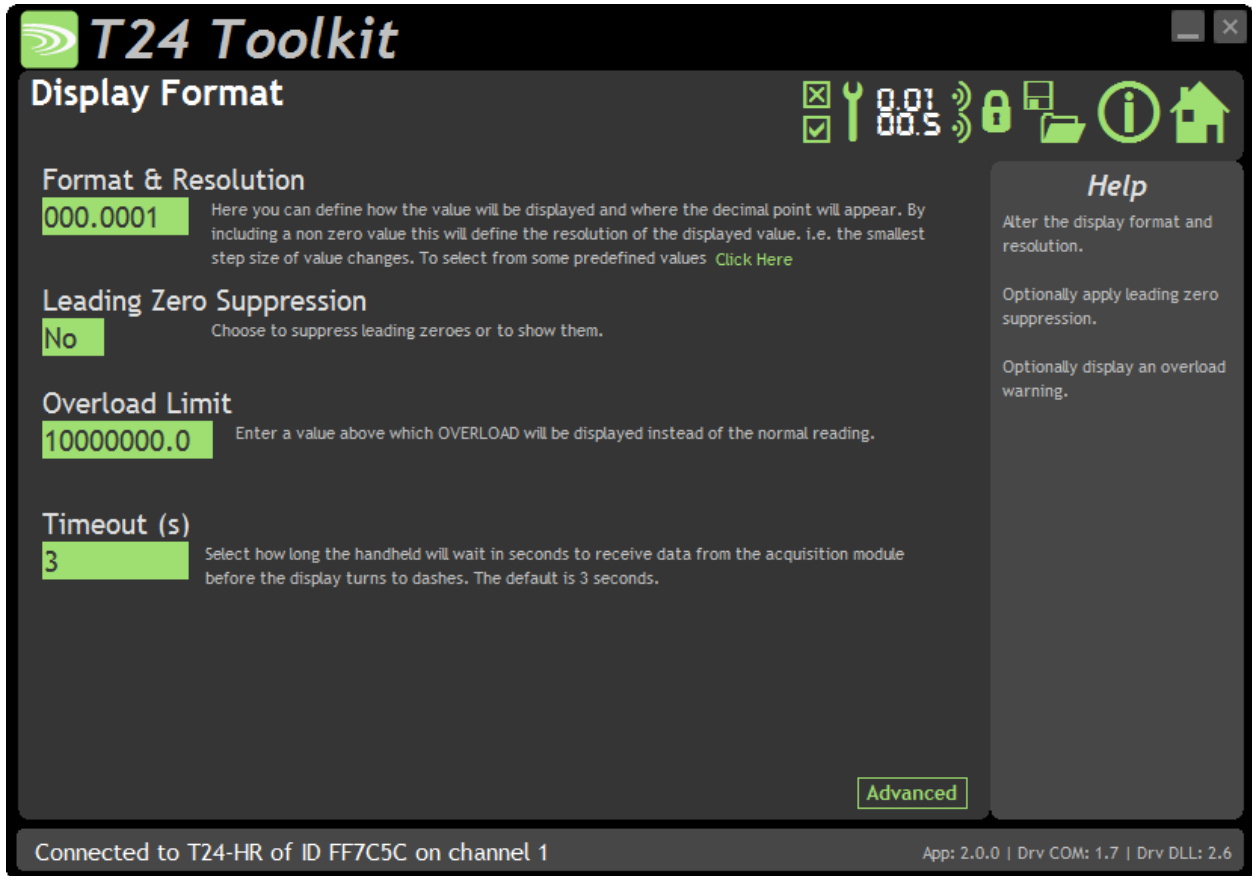

Here you can adjust the display.

#### Items you can change:

**Format & Resolution** Here you can define how the values are displayed on the LCD. There are 7 digits available and you can define where the decimal point is shown by entering numerals where a zero indicates a numeric digit position.

When the data is being displayed the number of decimal places you define may be overridden as the display will always show the correct number of integer digits.

Example: If you set the format to **000.0000** and the value to display is **100.1234** the display will show **100.123**

You can also define the resolution, which is the block size of changes to the display.

Example: If you enter the format as **000.0005** the display will only change in steps of 0.0005 which can be used to mask noisy digits at high resolutions.

Leading Zero Suppression	This can be turned on or off and will suppress leading zeroes when on. Example: If the display reads 000.123 with leading zero suppression turned off it will display 0.123 when leading zero suppression is turned on.
Overload Limit	You can enter a limit here above which <b>Overload</b> will be shown on the display instead of the actual value. Enter zero to disable this feature.
Timeout	Enter the timeout in seconds. This sets the time allowed without any data arriving from the viewed module before all dashes are displayed on the LCD. Should be at least 3 times the interval between the messages being sent by the transmitter module.
Advanced	This opens the advanced page where you can scale the displayed data.



Here you can adjust the display update rate and also scale the displayed data. This may be used, for example, to convert the data from a T24-SA calibrated in kg so that the handheld display shows lb.

**Items you can change:**

- Display Update Rate** Enter the interval in milliseconds between display updates. The default is 300 milliseconds. i.e. 3 updates per second.
- Custom Display Scaling** This can be used to change the displayed value to a different unit or to otherwise scale it. You simply enter the original and required values at a low and high point. Example: If a T24-SA was supplying data in kg and you wanted to show tonnes. You would keep both the low points at zero. Enter **At High Input Value** of 1000 and **Display Should Read** Value of 1.

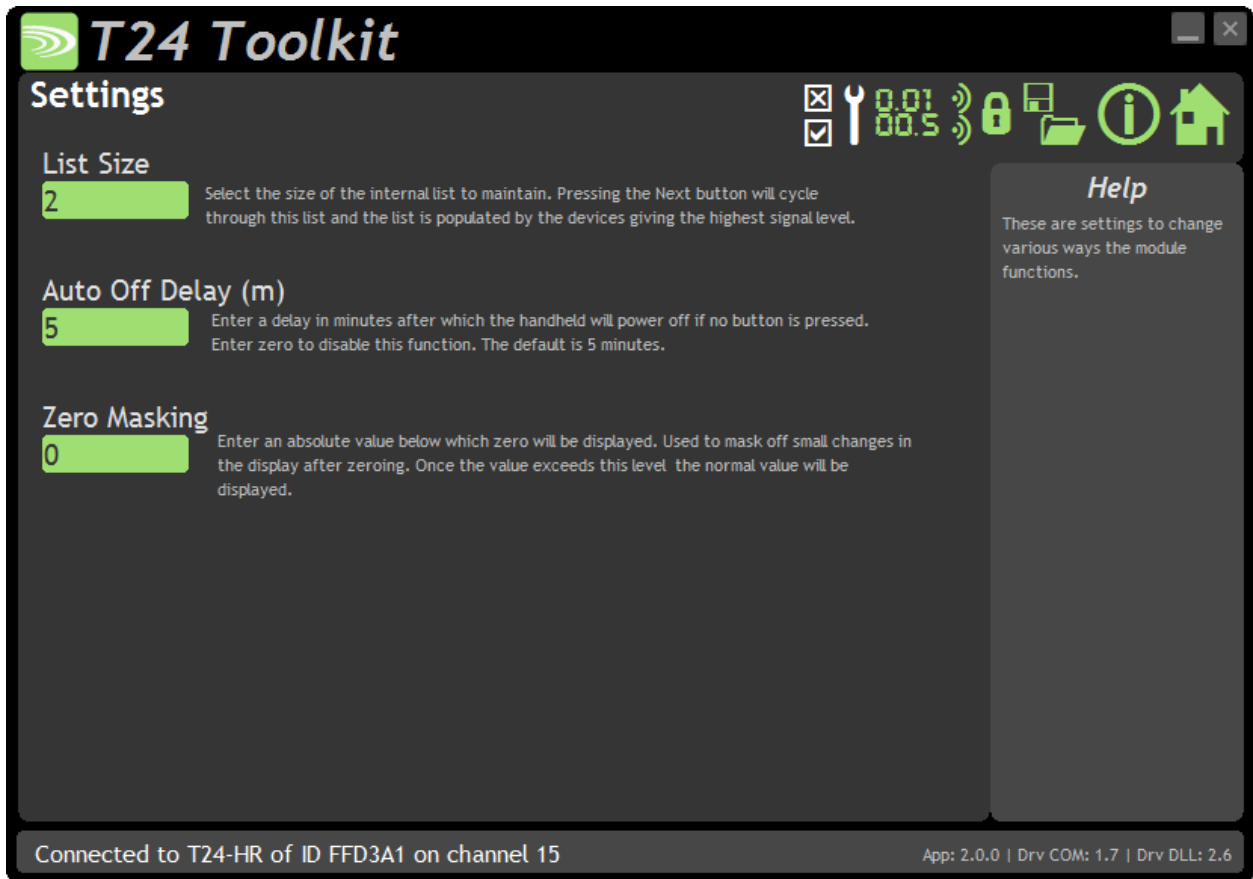

You should not normally need to change these settings.

**Items you can change:**

- List Size

This setting determines how many of the transmitter modules with the highest signal level make up the list which the next key cycles around.

Based on the application and how many transmitter modules are in the vicinity of the handheld this list size can affect how the operator uses the handheld.

See Example Scenarios in the Installation section next. Range is between 2 and 20.
- Auto Off Delay

Here you can specify the delay in minutes after which the handheld will automatically turn off after no button is pressed.

Enter zero to disable this function. The default is 5 minutes.
- Zero Masking

Enter a value in engineering units which represents a band (+/-) about zero within which zero will be displayed. As soon as the value is outside this band the real value will be shown. (Only available in version 1.01 onwards)

---

## Example Installation Scenarios

The following example scenarios explain the usage of the handheld and transmitter modules and lists the important settings chosen to achieve this.

---

### Scenario 1 – 200 transmitter modules are spaced at 1 meter intervals along a bridge.

The modules spend most of their time in deep sleep and are only activated when the operator uses the handheld. The transmitter modules are set for a message interval of 333 milliseconds (3Hz) and have a sleep delay of 5 seconds.

On the T24-HR setting the List Size to 6 allows the operator a fast responding Next key that cycles through the closest 6 modules to allow the operator to note any out of limit readings. The operator checks the Data Tag displayed on the handheld as the Next key is pressed against the Data Tag painted on the modules affixed to the bridge.

The operator walks the length of the bridge and stops approximately every 6 meters and quickly scrolls through the small list size and records the readings of the 6 local modules.

The list dynamically repopulates as he walks along the length of the bridge.

During the walk modules are automatically woken by the handheld as they enter range and as the operator walks out of range the modules automatically return to sleep.

---

### Scenario 2 – The operator has 3 rooms to monitor.

Each room contains 10 transmitter modules. These modules are always fully awake but operate at a transmission interval of 10 seconds. There is another module that is logging the data from these modules so their sleep delay is set to zero to disable that function.

By setting the List Size to 10 the operator can enter the desired room and simply cycle through the 10 modules present in that room.

Because the transmitter modules only send messages at 10 second intervals it can take up to 10 seconds for a particular module to be available from the handheld. The timeout on the handheld is set to 31 seconds.

The input to the transmitter modules is very slow to change so although the displayed value only updates every 10 seconds the operator is still seeing a valid reading as he cycles through the transmitter modules. The timeout of 31 seconds allows for the odd dropped reading but if a module dropped out permanently for whatever reason the handheld would display ----- after 31 seconds or the module would never appear in the list if it had not transmitted since the handheld had been turned on.

---

### Scenario 3 – 500 pallets are stored in a warehouse.

Each pallet has a T24-SA transmitter module built in that transmits the weight on the pallet. The T24-SA modules have been configured so that the LED state is echoed onto the digital output and this is used to power a high brightness blue LED attached to the front of the pallet. The module transmission intervals are set to 3 per second and a sleep delay of 10 seconds. The LED flashes at 3Hz while the module is awake and is off when asleep. When the handheld is displaying the reading from the module its LED is on constantly.

On the handheld the List Size is set to 1. This has the effect of allowing the operator to approach the desired pallet and press the **Next** key. This will effectively select the module with the highest radio signal which will be the one the operator is standing next to and the LED will light to provide visual feedback so the operator knows he is looking at the correct pallet.

The operator moves to the next pallet and presses the Next key again at which point the previous pallet LED goes off and the closest pallet LED activates.

As the operator moves out of range, pallets go back to sleep because of their sleep delay settings.

---

## Enclosure & Mounting

See [Appendix A – Handheld Style](#) section for more information.

---

## Antennas

These modules have the antenna already fitted inside the enclosure so there are no specific mounting requirements.

---

## Specification

<b>Electrical</b>	<b>Min</b>	<b>Typical</b>	<b>Max</b>	<b>Units</b>
Power Supply voltage	2.5	3.0	3.6	Vdc

<b>Power Supply</b>	<b>Min</b>	<b>Typical</b>	<b>Max</b>	<b>Units</b>
Active		35	40	mA
Low power mode		120	160	µA
Estimated Battery life using 2Ahr batteries:				
Standby mode (Powered off)		1.5		Years
Continuous operation		35		Hours

<b>Environmental</b>	<b>Min</b>	<b>Typical</b>	<b>Max</b>	<b>Units</b>
IP rating		IP67		
Operating Temperature Range	-10		+50	C
Storage Temperature	-40		+85	C
Humidity	0		95	%RH

<b>Physical</b>	
Hand Held Dimensions	90 mm x 152 mm x 34 mm

---

## Radio Range

To determine radio range please refer to [Appendix B – Antenna Range](#)



---

## T24-AO1, T24-AO1i

---

### Overview

The T24-AO1 and T24-AO1i provides an analogue output for the transmitter modules such as T24-SAx and T24-SAFx. The T24-AO1i is housed in an IP67 housing for industrial installation whilst the T24-AO1 is designed for desktop mounting.

The output can be selected from the following pre-calibrated Voltage and Current ranges. 0-10 V, +/-10 V, 0-5 V, +/-5 V, 0-20 mA, 4-20 mA both of which can be used in a 'sink' or source mode.

The T24-AO1 is configured by entering engineering values against the Output Minimum and Maximum Values. The analogue output is updated at a rate configured by the transmitter module's 'TXInterval'.

LEDs and, in the case of the T24-AO1i, open collector outputs, provide indication of the state of the radio link, remote battery life and remote status.

A 'Volt-free' digital Input on the T24-AO1i version allows for zeroing of the incoming data value.

The T24-AO1 and T24-AO1i are configured by the T24 Toolkit.

Version 1.1 brings the ability to wake the paired transmitter module when the analogue output module is turned on and to keep it awake while it remains powered up.

---

### Order Codes

---

#### T24-AO1



Analogue output module in desktop enclosure.

#### T24-AO1i



Analogue output in weatherproof industrial enclosure.

---

## Connections

---

### Power

You will need to connect a power supply to the T24-AO1 for it to operate and to enable configuration using a base station and the T24 Toolkit software.

Power is supplied via the screw terminals and can be in the range of 9 Vdc to 36 Vdc.

---

### T24-AO1

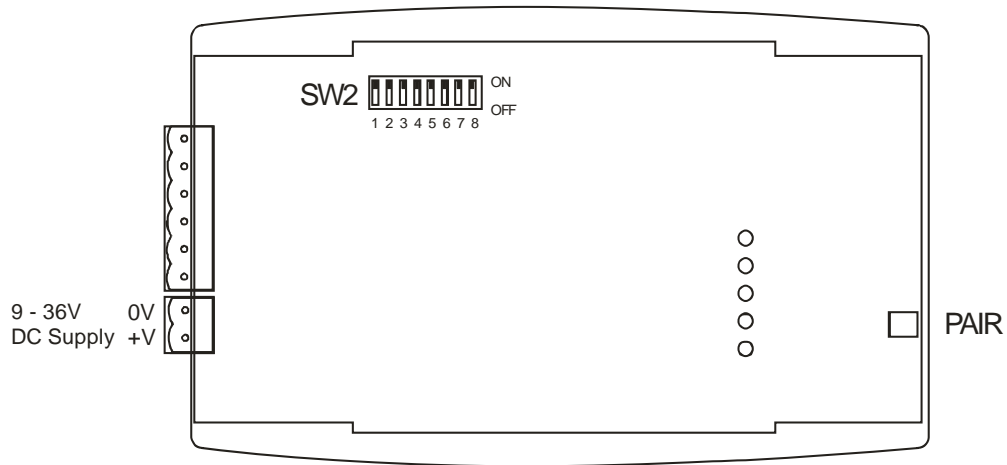

---

### T24-AO1i

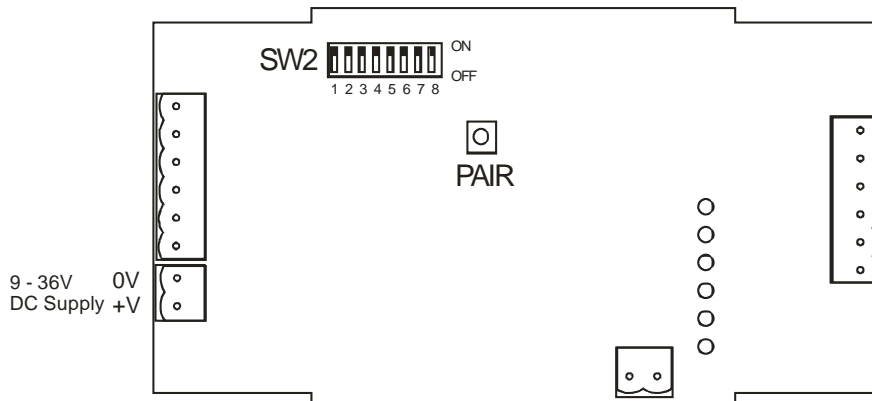

## Connections and Indicators

Depending on the analogue output module you have you will need to refer to one of the two following diagrams:

### T24-AO1

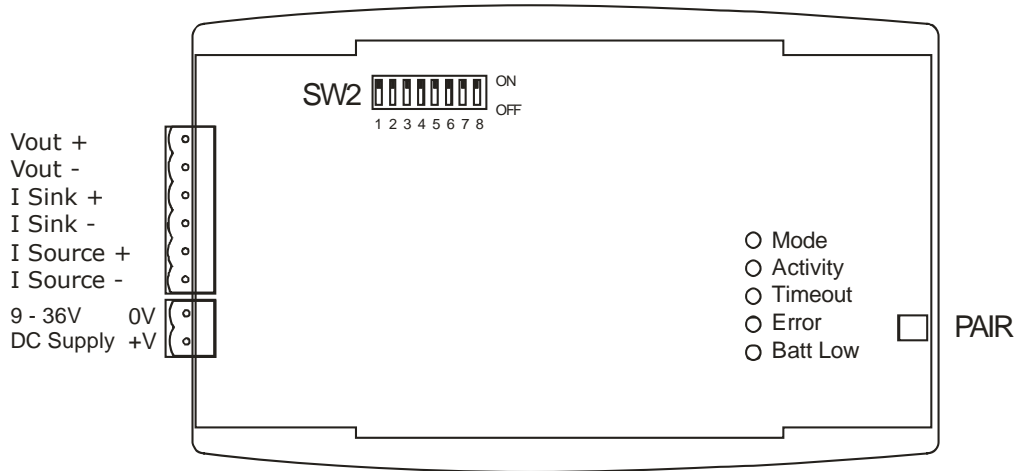

### T24-AO1i

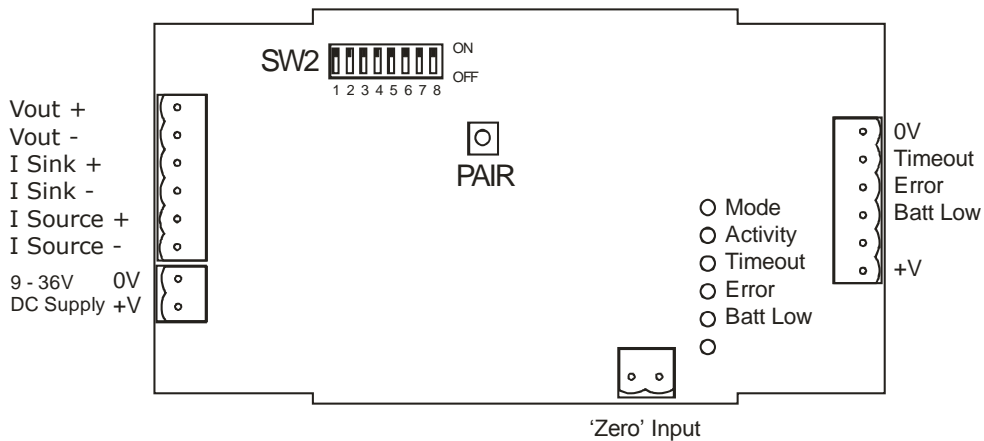

## Output Range Setting

To configure the required output range the DIP switches (SW2) require setting as follows. To access the DIP switches you will need to remove the cover from the case.

Range	SW2 Switch Settings							
	1	2	3	4	5	6	7	8
0-10 V	ON	OFF	OFF	X	X	OFF	ON	OFF
+/-10 V	OFF	OFF	ON	X	X	OFF	ON	ON
0-5 V	ON	ON	OFF	X	X	OFF	OFF	OFF
+/-5 V	ON	OFF	ON	X	X	OFF	OFF	ON
0-20 mA Sink	X	X	X	OFF	ON	ON	OFF	OFF
0-20 mA Source	X	X	X	ON	OFF	ON	ON	OFF
4-20 mA Sink	X	X	X	OFF	ON	ON	OFF	ON
4-20 mA Source	X	X	X	ON	OFF	ON	ON	ON

Where X = Doesn't matter

---

## LED Indicators

LED	Description
Mode	Flashing at 2Hz indicates normal operation. Constantly on indicates currently attempting to pair. Flashing at 4Hz indicates a failed pair attempt.
Activity	LED lights for 20ms each time data arrives. When data arrives at a rate greater than 50Hz the LED will appear constantly illuminated.
Timeout	Lost communications with the remote module.
Error	Remote module is reporting an error.
Batt Low	Remote module is reporting a low battery.

---

## Configuration

The T24-AO1 is configured by setting the Data Tag of the module whose data you wish to reflect onto the analogue output.

Once you know the data tag you then need to work out which calibrated values from the transmitter module you want represented by the selected analogue output minimum and maximum levels.

For example: A T24-SA has been calibrated to give 0 to 10 tonnes output. You have selected a 4-20mA analogue output and want the output to give 4mA at 0 tonnes and 20mA at 8 tonnes. Simply set the **In Minimum** to 0 and **In Maximum** to 8.

Next you set the desired actions when errors occur.

To associate the T24-AO1 with a transmitter module you just need to let the T24-AO1 know the Data Tag of the data to use.

This can be done manually using the T24 Toolkit (See below) or this can be achieved using the Pair button of the T24-AO1.

When first configuring the T24-AO1 it really makes no difference which technique is used but if you were replacing a data transmitter module in the field the switch technique would negate the need for the Toolkit or a base station.

To perform a 'pair' first remove the power from the transmitter module. Next, press the Pair Switch on the T24-AO1 then within 10 seconds re-apply power to the transmitter module. The mode LED will indicate the success or failure of this operation (See above table).



*To access the Pair Switch on a T24-AO1i you need to remove the lid. The Pair Switch can be accessed through a hole in the end of the case on a T24-AO1; a straightened paper clip could be used.*

An advantage of using the Pair Switch is that you can pair to any transmitter module regardless of its radio channel or group key settings. When you pair the transmitter module settings will be changed to match those of the T24-AO1. If you manually enter the Data Tag using the T24-Toolkit you will need to ensure that both the transmitter module and the T24-AO1 are on the same radio channel and are using the same group key.

---

## T24 Toolkit

The T24 Toolkit provides a means of simple configuration and calibration of the module along with useful tools to aid integration.

Launch the T24 Toolkit software application and pair to this module to enable the connection to the Toolkit to allow configuration to take place. [See Common Toolkit Pages - Home](#)



Here you set the properties that determine the input and output relationship.

**Items you can change:**

**Input**

In Minimum

Enter the input value that should result in the minimum output. The minimum output depends on the Current Selected Output which is determined by the SW2 DIP switch settings.

Range	Minimum Output
0-10 V	0 V
+/-10 V	-10 V
0-5 V	0 V
+/-5 V	-5 V
0-20 mA Sink	0 mA
0-20 mA Source	0 mA
4-20 mA Sink	4 mA
4-20 mA Source	4 mA

In Maximum

Enter the input value that should result in the maximum output. The maximum output depends on the Current Selected Output which is determined by the SW2 DIP switch settings.

Range	Maximum Output
0-10 V	10 V
+/-10 V	10 V
0-5 V	5 V
+/-5 V	5 V
0-20 mA Sink	20 mA
0-20 mA Source	20 mA
4-20 mA Sink	20 mA
4-20 mA Source	20 mA

Input value

This shows the currently supplied value to the T24-AO1. An active transmitter module must be in place to view this value.

Click Format to select a display format.

### Output

Smoothing

Click here to select whether to apply smoothing to the output.

The analogue output is updated at a rate of 2KHz.

When no smoothing is applied the output changes as soon as new data arrives from the transmitter module.

When smoothing is active the output is ramped between the last input value and the current input value at a rate of 2KHz. This has the effect of delaying the output (latency) by the interval between values being delivered to the input. i.e. The T24-AO1 must receive an input value then start to ramp up to it from the previous input value.

Example: with a transmitter module delivering data at 3Hz the T24-AO1 output would have a latency of 333ms when smoothing is active.



*This option will have no effect when the input module is a T24-SAf 2KHz fast transmitter.*

Current Selected Output

This shows the currently selected output range as set by the SW2 DIP switches.



Some of the DIP switches are used to indicate to the module the selected range and others are used to route circuitry so although this display may indicate the selected range that does not mean that all switches are in the correct position for the range to work correctly. Always check the SW2 DIP switch table for the correct settings.



Here you can set the action to take when certain errors occur. The actions are applied when the errors occur and if more than one error is present the actions are applied with the following priorities:  
 Timeout Action, Remote Error Action, Remote Batt Action

When errors are removed the analogue output resumes reflecting the current input.

**Items you can change:**

- Timeout

Enter the timeout in milliseconds for the input to timeout. If a new Data Provider packet does not arrive within this time the **Timeout Action** will trigger. Generally this timeout should be set to at least three times the transmitter module transmission rate.
- Timeout Action

Select the action to take place when a timeout occurs. i.e. when communications (for more than the duration of the Timeout value) are lost with the transmitter module.  
 See the **Output Actions** section for the available actions and the effect of these choices on the different output ranges.
- Remote Error Action

Transmitter modules can report errors. You will need to refer to the module manual for information regarding what constitutes an error.  
 See the **Output Actions** section for the available actions and the effect of these choices on the different output ranges.
- Remote Batt Action

When the transmitter module reports a low battery this action will occur.  
 See the **Output Actions** section for the available actions and the effect of these choices on the different output ranges.



## Output Actions

The following actions can be selected.

<b>None</b>	Do nothing
<b>Minimum Full Scale</b>	Set analogue output to the minimum full scale value
<b>Maximum Full Scale</b>	Set analogue output to the maximum full scale value
<b>Minimum Output</b>	Set analogue output to the minimum possible value
<b>Maximum Output</b>	Set analogue output to the maximum possible scale value
<b>Half Full Scale</b>	Set analogue output to halfway between minimum and maximum full scale value
<b>Hold Last Output</b>	Hold the last output. (Does the same as None for the <b>Timeout Action</b> )

The following table shows the output that can be expected for each range.

Action	Output Range					
	0-10 V	+/-10 V	0-5 V	+/-5 V	0-20 mA	4-20 mA
None	-	-	-	-	-	-
Minimum Full Scale	0	-10	0	-5	0	4
Maximum Full Scale	10	10	5	5	20	20
Minimum Output *	-0.5	-11	-0.3	-5.5	0	0
Maximum Output *	11	12	5.4	6	22.4	22.4
Half Full Scale	5	0	2.5	0	10	12
Hold Last Output	-	-	-	-	-	-



\* The values shown here are approximate. Each module will vary depending on tolerances of electronic components.

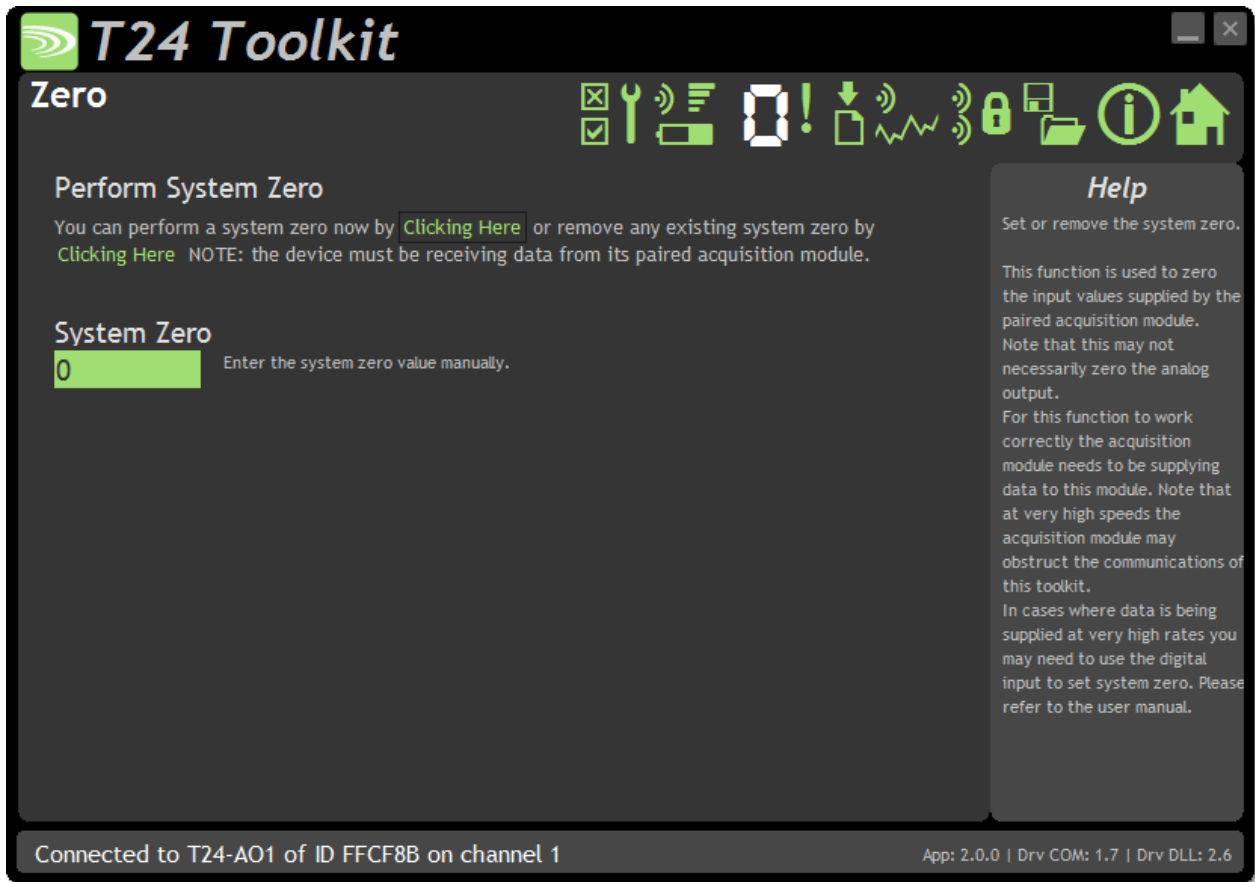

System zero allows you to zero the input. The system zero value is subtracted from the input value before it is used to determine the analogue output to apply.

**!** Performing a System Zero will have the same effect as if the input value to this module is zero which does not necessarily zero the output from this module. The output value will depend on the Input/Output scaling.

This page allows either manual entry or to zero the current input value.

**Items you can change:**

- |                     |   |
|---------------------|---|
| Perform System Zero | Click to use the current input value as the new system zero.                                      |
| Remove System Zero  | Remove the system zero so that the input value is directly used to determine the analogue output. |
| System Zero         | Enter the required system zero value.   |

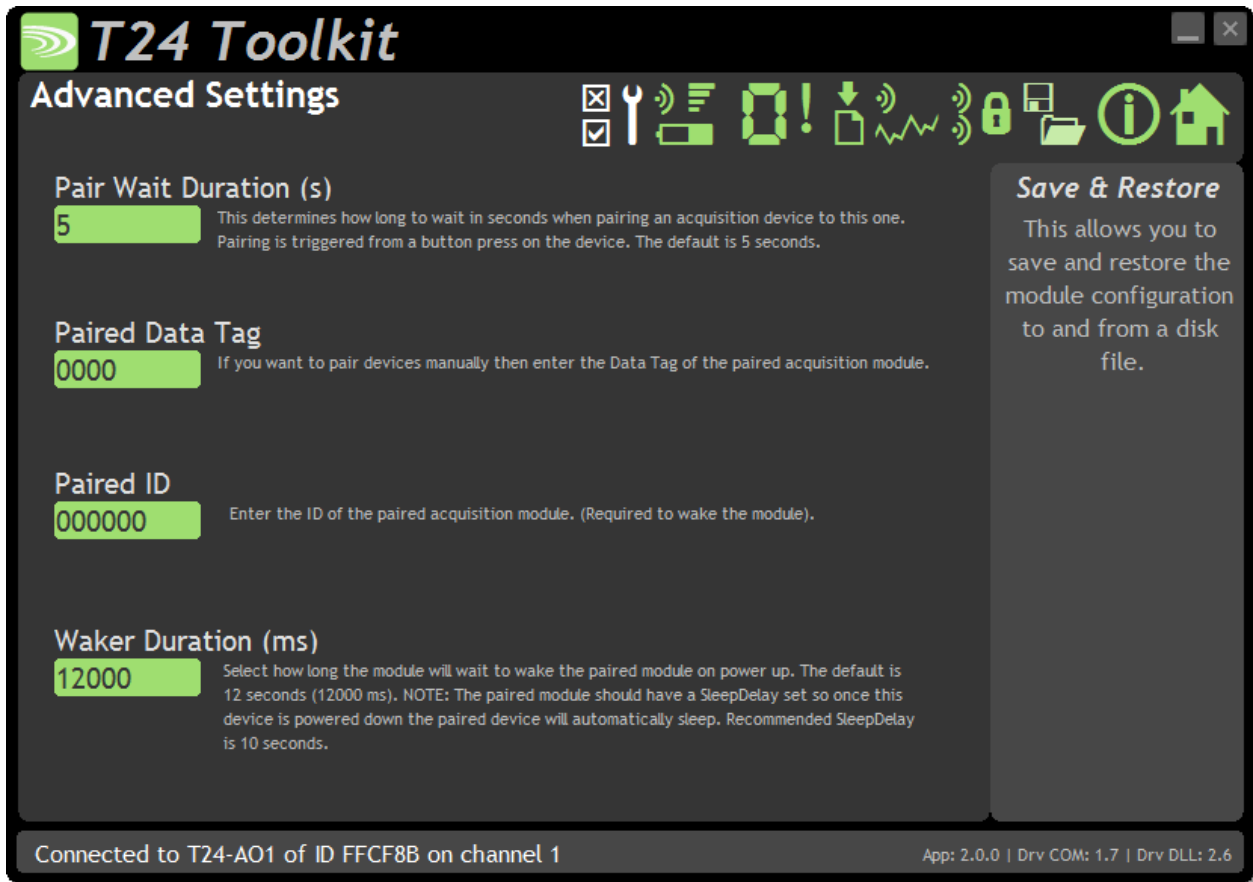

This page allows effective conversion between units. i.e. Although all modules supplying data are configured in kg you can get a printed output in lb.

**Items you can change:**

- Pair Wait Duration      Here you can set the duration that the T24-AO1 will wait to achieve successful pairing after the Pair Switch is pressed. The default is 5 seconds.
  
- Paired Data Tag      This shows the currently paired Data Tag. You can click this to manually enter a Data Tag.
- Paired ID      Version 1.1 onwards. This shows the ID of the paired module. This is required if the analogue output module is to wake the transmitter module when it is first powered on.
- Waker Duration (ms)      Version 1.1 onwards. To wake the paired transmitter module on power up and to keep it awake you need to enter a time to try waking the module in milliseconds. The default is 12000ms (12 seconds).

**Enter zero to disable the automatic waking of modules.**

**i** *The paired transmitter module should have its SleepDelay parameter set so that once the analogue output module is turned off the remote module will go back to sleep on its own. The recommended time for the sleep delay is 10 seconds or 10000ms.*

---

## Enclosure & Mounting

---

### T24-AO1

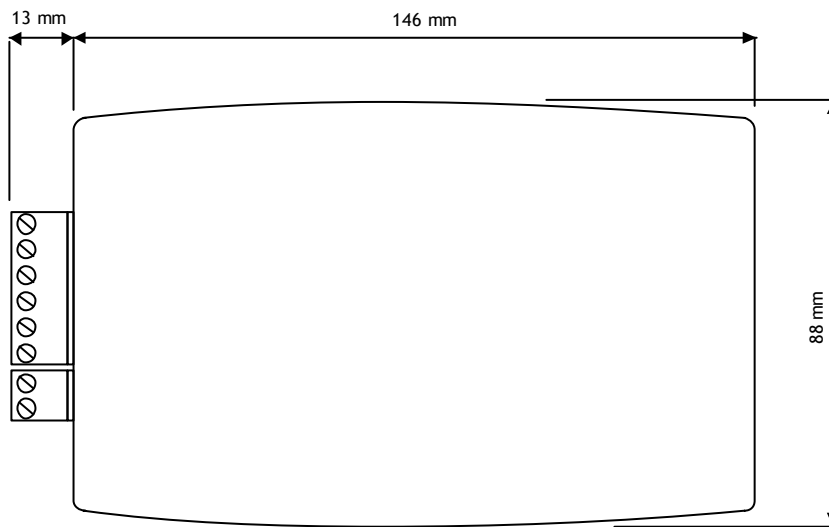

---

### T24-AO1i

This module is fitted inside our ACM ABS enclosure. Please see [Appendix A – Enclosures & Mounting – ACM](#) for more information.

---

## Antennas

These modules have the antenna already fitted inside the enclosure so there are no specific mounting requirements.

## Specification

Parameter	Minimum	Typical	Maximum	Units	Notes
External Supply voltage Range	9	12	32	Vdc	
Operational Current	-	85	150	mA	
Operating Temperature Range	-20	-	55	°C	
Storage Temperature Range	-40	-	85	°C	
Reverse polarity Protection	-	-	-32	Vdc	Maximum Supply level
Digital output Drive voltage			30	Vdc	
Digital output Drive Current			20	mA	
Source Impedance driving			200	Ω	
Digital Input (volt-free contact)					
<b>Voltage output</b>					
Resolution		16		Bits	
output gain stability	-	0.008	0.015	± % FS/°C	
output zero stability	-	0.005	0.015	± % FS/°C	
Short term stability (1 hr)	-	0.003	0.01	± % FS	
Long term stability (10k hrs)	-	0.03	0.1	± % FS	
Residual ripple		40		mV p-p	
Minimum load impedance	5000			Ω	
Linearity	-	0.007	0.01	± % FS	
<b>Current output</b>					
Resolution		16		Bits	
4-20mA output gain stability	-	0.006	0.03	± % FS/°C	
4-20mA output zero stability	-	0.003	0.02	± % FS/°C	
Short term stability (1 hr)	-	0.006	0.03	± % FS	
Long term stability (10k hrs)	-	0.06	0.2	± % FS	
Residual ripple		0.032		mA p-p	
Settling time to ±0.5µA (thermal effects)	-	5	-	secs	
Maximum load impedance			500	Ω	
Linearity	-	0.01	0.02	± % FS	
<b>Physical Dimensions</b>					
T24-AO1			166 X 87 X 26 mm		
T24-AO1i			190 X 80 X 55 mm		
<b>Environmental</b>					
T24-AO1			IP50		
T24-AO1i			IP67		
Humidity			95%RH (max)		

## Radio Range

To determine T24-AO1i radio range please refer to [Appendix B – Antenna Range](#)  
 The T24-AO1 has a maximum range of 100m

---

## T24-RM1

---

### Overview

The T24-RM1 offers dual power relays capable of mains power switching. These relays can be configured as high, low or window alarms and can be associated with a group of up to 8 T24 transmitter modules per relay.

Relays can operate when the sum of the assigned transmitter modules reach a setpoint or when any of the modules reach the setpoint. There is also a mode where the difference between the lowest and highest value is compared to the setpoint. This is ideal for applications where you are looking for a group of weights to be within a certain band. i.e. balancing four corners of a weigh scale or a hanging truss.

Relays can be latched and a digital input or external command can be used to reset them.

An alarm/error signal relay is operated if communication is lost or other selectable errors occur and this alarm resets once the source of the alarm or error is removed.

This module is supplied in an IP67 sealed ABS case but a DIN rail option is available.

The state of the power relays during an error can be selected.

---

### Order Codes

---

#### T24-RM1



Relay module housed in weatherproof enclosure.

## Connections

### Power

You will need to connect power to the T24-RM1 for it to operate. Only power is required to enable configuration using a base station and the appropriate toolkit software.

Power is connected to the two part two way screw terminal connector as shown in the diagram below.

### Connections & Indicators

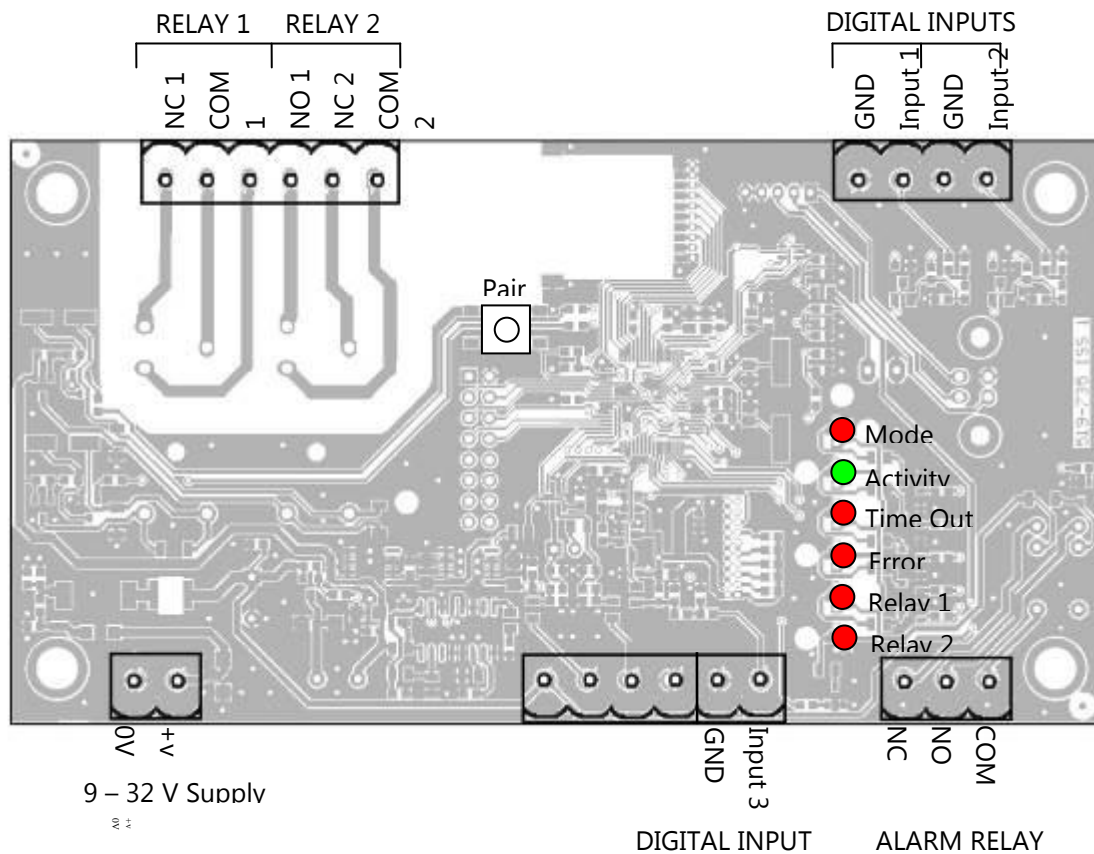

### LEDs

Mode	Flashes 2 x per second when operational
Activity	Flashes when T24 data packets are received
Time Out	No T24 data present for longer than user defined period
Error	Remote T24 error from any defined T24 input module
Relay 1	Relay 1 Energised (Connection between COM and NO)
Relay 2	Relay 2 Energised (Connection between COM and NO)

### Inputs

Digital Input 1	Can either reset a latched relay 1 or transmit a Data Provider Packet of a specified Data Tag
Digital Input 2	Can either reset a latched relay 2 or transmit a Data Provider Packet of a specified Data Tag
Digital Input 3	Resets both latched relays

## Operation

The T24 RM1 can accept 8 T24 data inputs for each of the two relays, the total of the inputs compared to the set point and mode of the relay channel affects whether the relay is energised or not. In addition when considering the use relays attention should be paid as to what state the system will be in when the power is off. The diagram below outlines how wiring and normal and inverse modes influence the state of relays.

(COM = Common, NO = Normally Open, NC = Normally Closed)

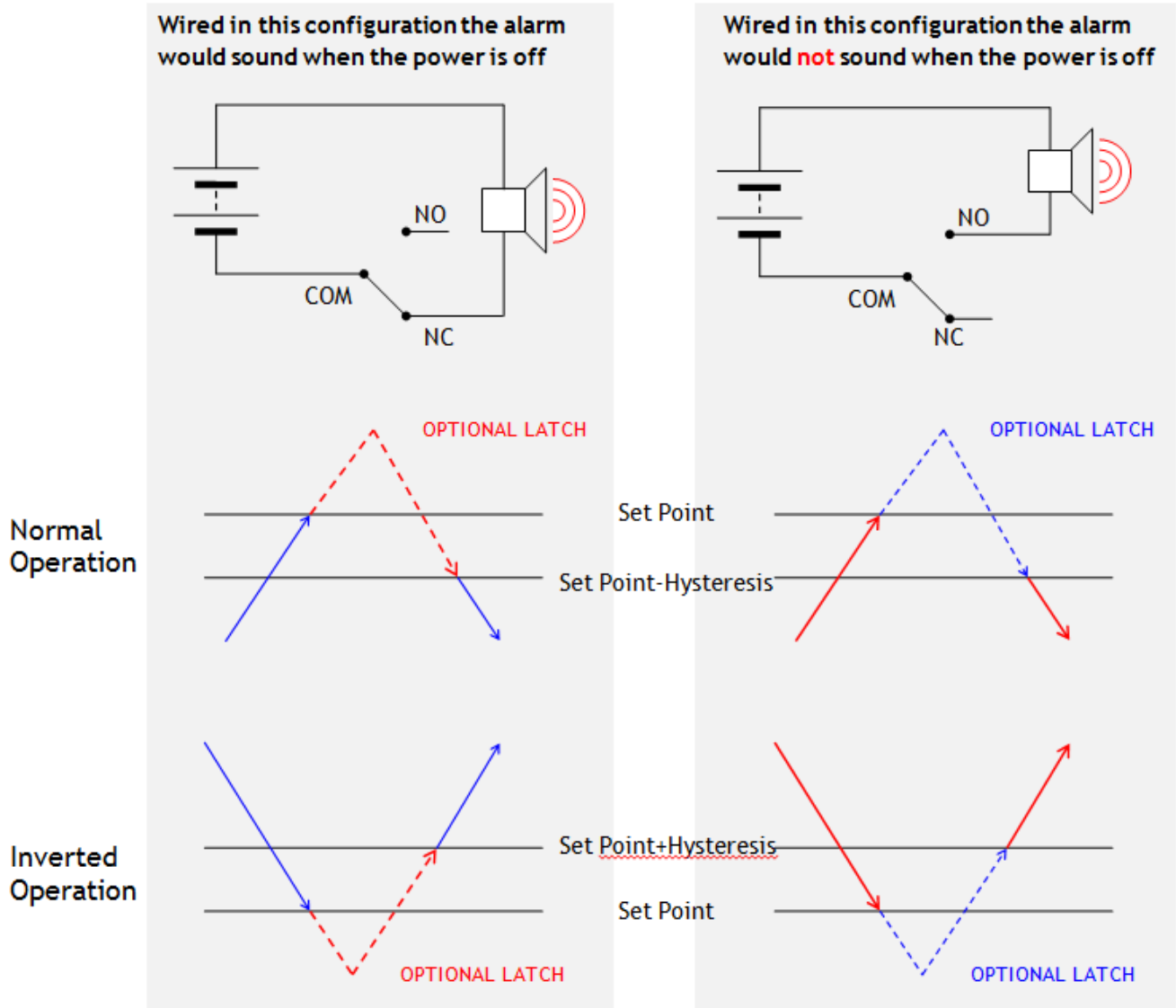

### KEY:

↗	Increasing Value	_____	Relay Energised	_____	Alarm Activated
↘	Decreasing Value	-----	Relay Unenergised	_____	Alarm Deactivated

Relays can change state due to the following events:

- Arrival of T24 data from user defined T24 module that causes the relay output to trigger.
- Triggering of digital input 1 or 2 (switch input) which if configured reset latched relays
- Arrival of data from a specified data tag can reset latched relays.
- A change in error state of a module specified in a relays list of inputs

The T24-RM1 also features a third Alarm relay. The Alarm relay is energised from start up, (connection made between COM and NC). The relay de-energises if an error is detected, an error is classed as a timeout and optionally can include Integrity error or low Battery. The Alarm Relay will return to normal (energised) once the source of the error is removed.



## Configuration

The T24 Toolkit provides a means of simple configuration of the module along with useful tools to aid integration.

Launch the T24 Toolkit software application and pair to this module to enable the connection to the Toolkit to allow configuration to take place. [See Common Toolkit Pages - Home](#)

## Input Settings

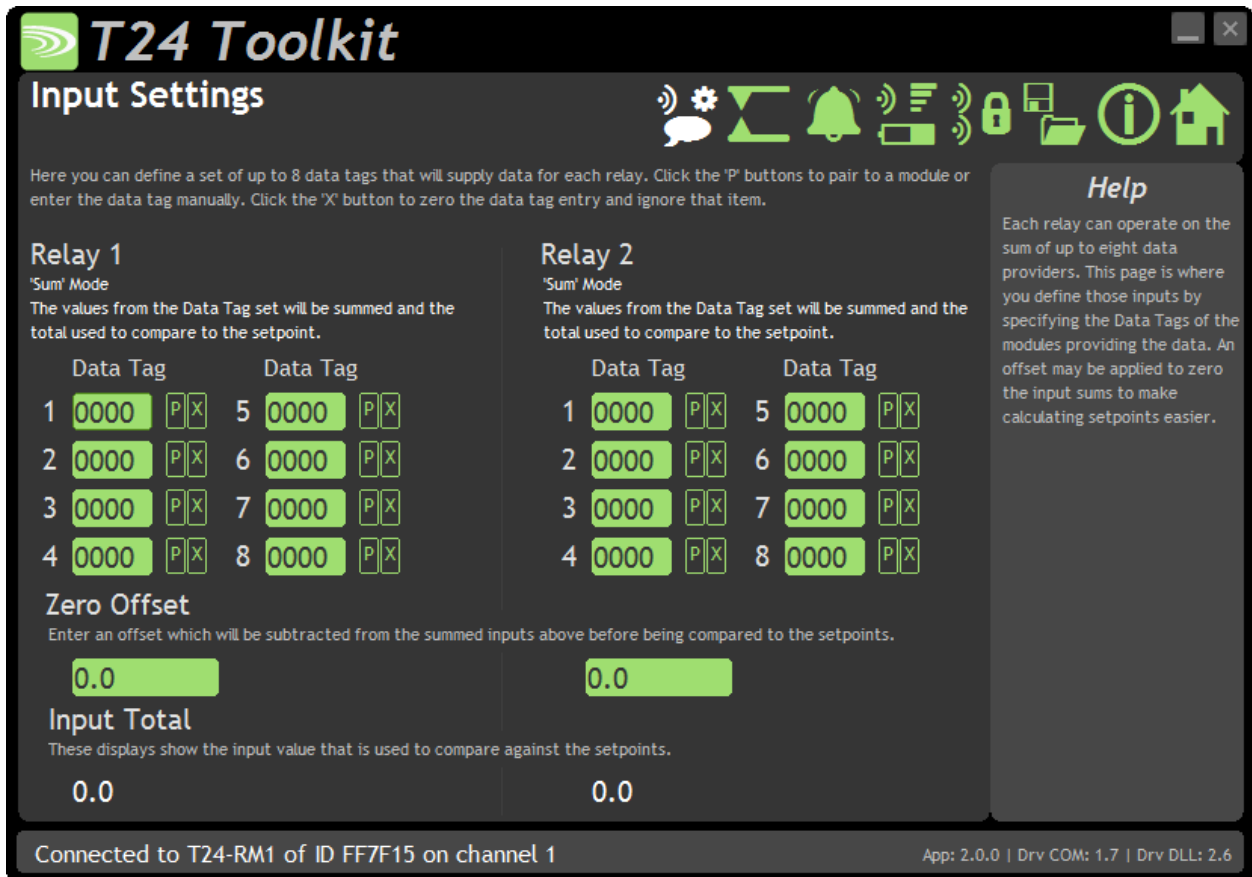

Here you can set the Data Tags of the data used as the inputs.

The description in green below the 'Relay1' and 'Relay2' captions indicate the way in which the values from the Data Tags will be used to compare against the setpoint to determine whether the relay will activate.

See the **Relay Operation Settings** section for details.

### Items you can change:

- |                    |   |
|--------------------|---|
| Relay1DataTag[1-8] | Enter up to eight Data Tags the data from which will be used to determine the value compared to the set point to control relay 1. |
| Relay2DataTag[1-8] | Enter up to eight Data Tags the data from which will be used to determine the value compared to the set point to control relay 2. |
| Zero Offset [1-2]  | This value will be subtracted from the total of the summed data from the data tags for Relay 1 and relay 2.                       |

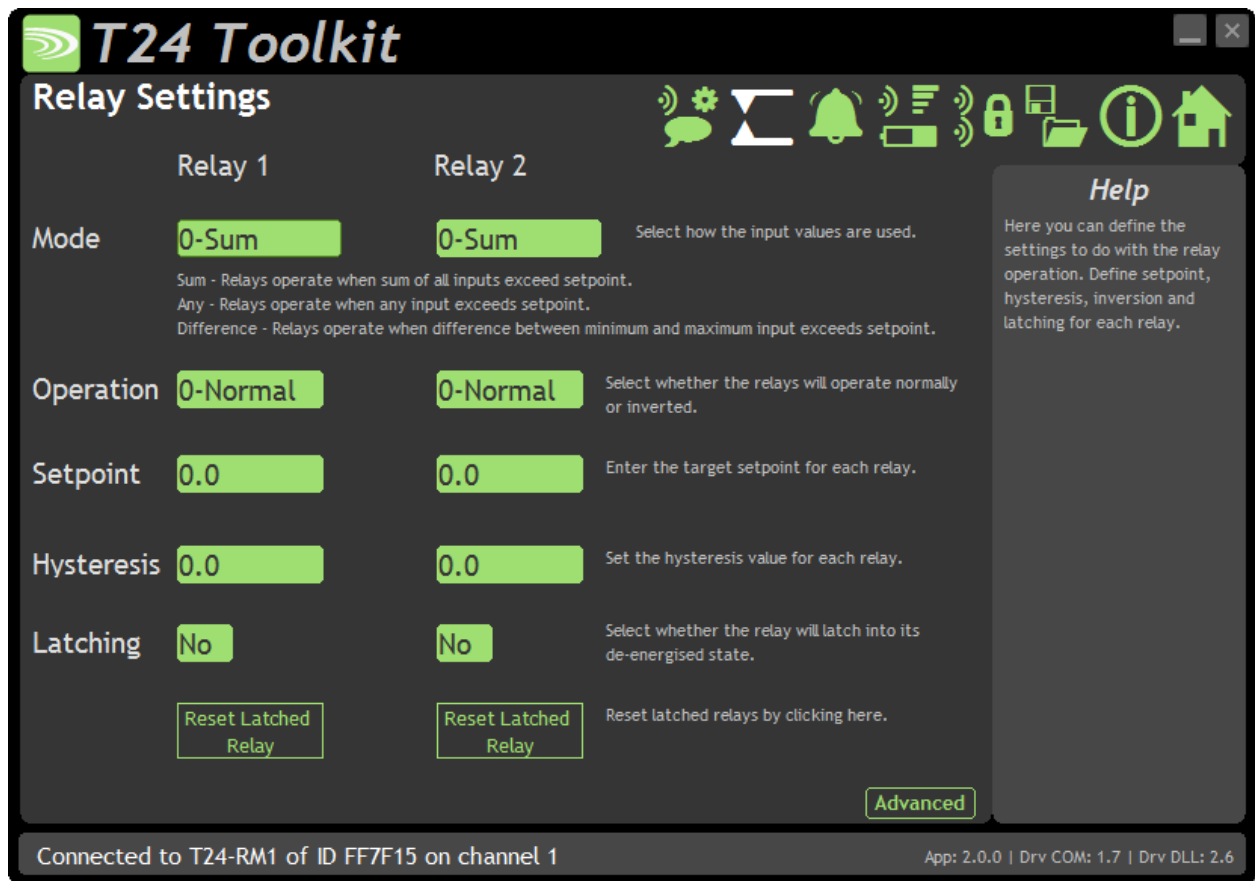

Here you can change various settings that influence the operation of the individual relays.

**Items you can change:**

- Mode [1-2]      This setting determines how the Data Tag values are used to compare against the setpoint. This is only available in firmware versions 2.0 and above. Previous versions will operate only in 'Sum' mode.

  - **Sum** – The values of the defined Data Tags are summed and this summed total is compared to the setpoint.
  - **Any** – The Data Tag with the highest value is compared to the setpoint. i.e. If any of the individual transmitter modules exceed the setpoint.
  - **Difference** - The difference between the lowest and highest values of all the Data Tags is calculated and this difference (Which is absolute i.e. always positive) compared to the setpoint.
  
- Operation [1-2]      Whether set to normal or inverse decides how the relay state corresponds to the set point and hysteresis. (See diagram on next page)
  
- Setpoint [1-2]      The Set Point is the level at which the relay state will change, see below.
  
- Hysteresis [1-2]      This value sets an offset between when the relay is energised and de-energised creating a de-bounce for the relay. (See diagram on next page)
  
- Latching [1-2]      Latching locks the state of the relay when it passes the set point.
  
- Advanced Button      Displays the Relay Settings Advanced page.

## Operation and Hysteresis Settings

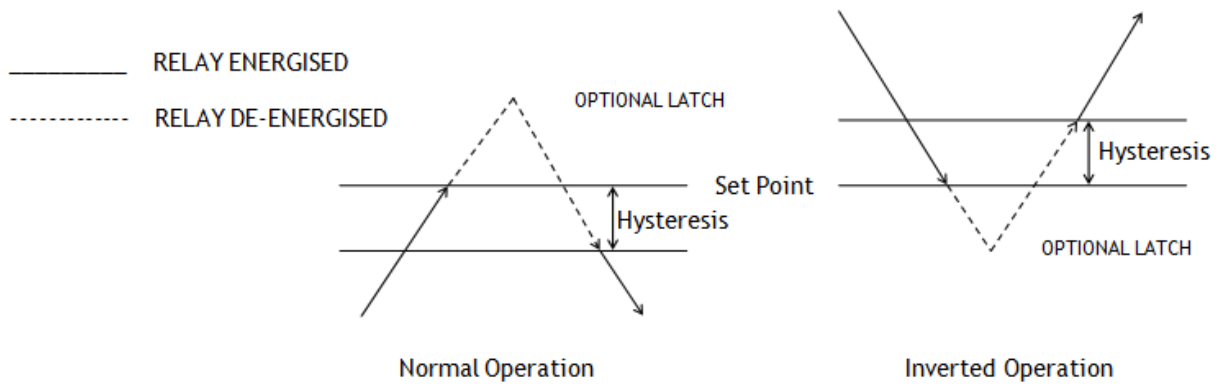

Relay de-energises when reaching the set point.



Here you can change various settings that influence the operation of the individual relays.

**Items you can change:**

Relay Reset Data Tag [1-2]      Enter a Data Tag that on receipt will reset the latched relay. Enter zero to disable this feature.

Waker Duration      Enter zero to disable this feature.  
 Enter a time in milliseconds for this module to attempt to wake transmitter modules when first powered up. The default is 12000 milliseconds (12 seconds). All modules on the same radio channel and sharing the same Group key will be woken when the relay module powers up when this function is enabled.

Transmitter modules will be kept awake while this module has power applied. The transmitter modules should have a Sleep Delay set so that after the relay module has been powered down the transmitter modules then return to sleep.

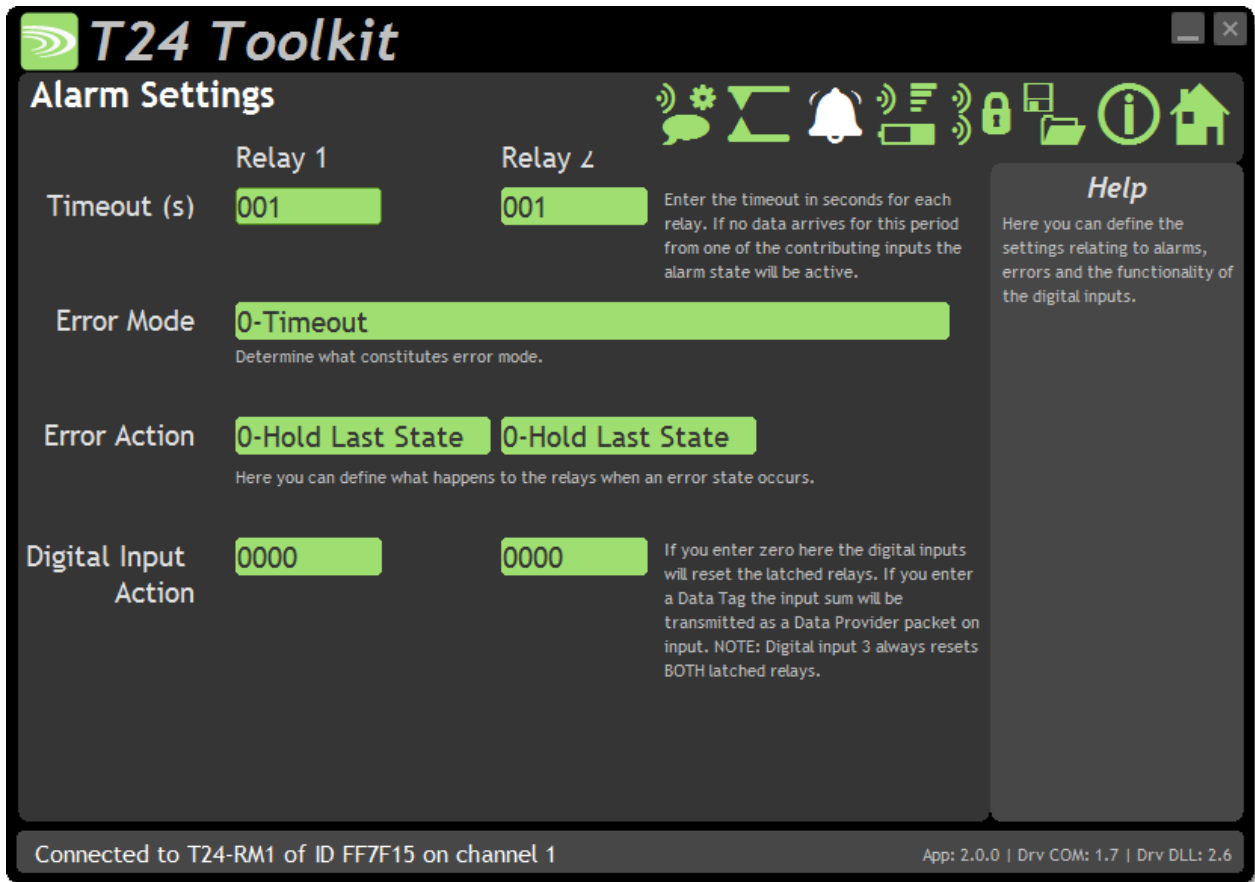

This page defines how the individual relays will react to time outs and errors present from any defined T24 module, as well as how Digital inputs 1 and 2 are used.

**Items you can change:**

- Timeout

Enter a time in seconds that if exceeded the T24-RM1 will affect the relay state according to the error action, as well as set the alarm relay and light the time out LED
- Error Mode

The error mode defines what is causes the alarm relay and individual error action to be triggered. Errors can be defined as

  - Time out
  - Time out or Low Battery
  - Time out or Low Battery or Integrity Error
- Error Action

For each relay the action upon error detection can be defined as ;

  - Hold Last State
  - De-Energise Relay
  - Energise Relay
- Digital Input 1

Digital input 1 can be used to either

  - Reset Relay 1 from its latched state
  - Transmit a data provider with user defined data tag containing the total of the inputs of Relay 1
- Digital Input 2

Digital input 2 can be used to either

  - Reset Relay 2 from its latched state
  - Transmit a data provider with user defined data tag containing the total of the inputs of Relay 2

---

## Enclosure & Mounting

This module is fitted inside our ACM ABS enclosure. Please see [Appendix A – Enclosures & Mounting – ACM](#) for more information.

---

## Antennas

These modules have the antenna already fitted inside the enclosure so there are no specific mounting requirements.

---

## Specification

	<b>Min</b>	<b>Typical</b>	<b>Max</b>	<b>Units</b>
PSU	9	-	32	Vdc
Operational Current All Relays Active		155*		mA
Power Relays		240V 5A		
Alarm Relay		1A 24 Vdc	1A 120 Vac	
Operational Temperature Range	-10		60	°C
Storage Temperature Range	-40		70	°C
Humidity	0		95	%RH
IP Rating		IP67		

\* At 12 Volt nominal Supply

---

## Radio Range

To determine radio range please refer to [Appendix B – Antenna Range](#)

---

## T24-SO

---

### Overview

The T24-SO creates a serial output which can include data from up to 8 modules and optionally sum them. The output is suitable for connecting to a printer, serial display or for feeding directly into a PC, PLC or any module that is capable of using numeric values in readable ASCII format.

The actual serial output can be designed by the user using multiple lines which can include free text or tokens which can represent real data. i.e. **<V1>** would be decoded as the value from input 1 when the print is triggered. Printing can be triggered from a contact, an external command or the arrival of a specific **Data Provider** message.

The serial output can consist of a single line of data suitable for feeding into an LED display module or a more complex multi-line result that can contain a mixture of fixed and variable data suitable for tickets, receipts etc. for printed output.

---

### Order Codes

---

#### T24-SO



Serial output module in weatherproof enclosure.



## Connections

### Power

You will need to connect power and serial to the T24-SO for it to operate. Only power is required on J4 to enable configuration using a base station and the appropriate toolkit software.

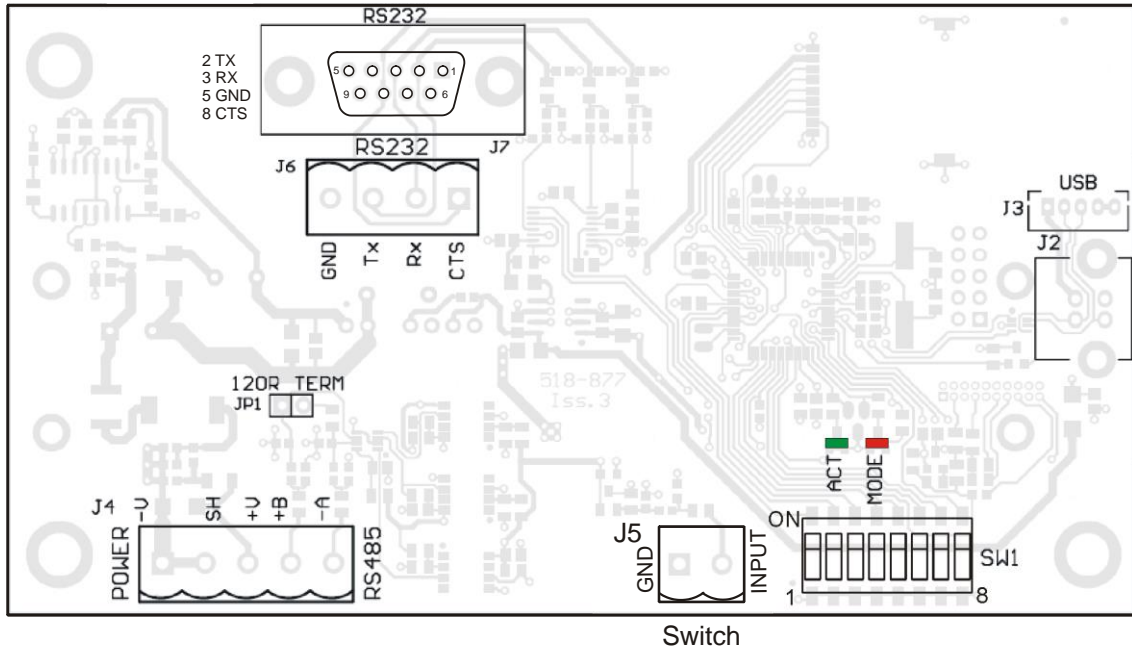

### Serial Settings

The serial output is set at 8 data bits, 1 stop bit and no parity. The baud rate can be selected as can RS232 or RS485 operation.

### SW1 Settings

Switch positions 1 to 4 are not used and can be in any position.

Switch positions 5 to 7 control the baud rate for the serial interface.

	5	6	7
<b>Baud rate</b>			
NA	Off	Off	Off
9600	On	Off	Off
19200	Off	On	Off
38400	On	On	Off
57600	Off	Off	On
115200	On	Off	On
230400	Off	On	On
460800	On	On	On

This switch position selects whether the serial interface is RS232 or RS485.

	8
<b>232/485</b>	
RS232	Off
RS485	On

---

## RS232

The RS232 interface uses TX, RX and GND to connect to a PC, PLC etc. and uses standard RS232 voltage levels.

The baud rate can be selected by setting the DIP switches stated above.

**i** The T24-GW1 will require power cycling to utilise a baud rate change.

---

### Example connection to a PC 9 way D serial connector.

PC 9 Way D Plug Pin	Signal Direction	Signal	Base Station Connection
3 (TX)	->	RX	J6 RX or J7 Pin 3
2 (RX)	<-	TX	J6 TX or J7 Pin 2
5 (Gnd)		GND	J6 GND or J7 Pin 5
8 (CTS)	<-	CTS	J6 CTS or J7 Pin 8

---

## RS485

The RS485 interface (This is a 2 wire 485 interface and will not work with 4 wire 485 buses) uses TX, RX and GND to connect to a PC, PLC etc. and uses standard RS485 voltage levels.

The baud rate can be selected by setting the DIP switches stated above.

**i** The T24-GW1 will require power cycling to utilise a baud rate change.

---

### Example connection

Depending on the RS485 interface or hardware the connections vary and are not standard therefore we can only show the connections to the T24-GW1. You must refer to the user manual regarding your RS485 connection to ascertain the correct connections.

PC / PLC Connection	Signal	Base Station Connection
Refer to RS485 Device User Manual	A	J4 -A
Refer to RS485 Device User Manual	B	J4 +B
Refer to RS485 Device User Manual	GND	J4 SH

---

## Serial Limitations

- When using RS232 or RS485 you should use the fastest baud rate possible. At lower rates data can be lost because it can arrive from the radio faster than the gateway station can send it serially.

---

## Configuration

Once it has been determined how many modules are feeding data to this module you need to record the Data Tag that each of these modules are attaching to their Data Provider packets. These Data Tags are then entered into the **ValueDataTagx** parameters. Once the rate at which this data arrives is known you can enter the **Timeoutx** values. Leave unused **ValueDataTagx** parameters with a value of zero to ensure that they are not checked for timeouts and do not contribute to gross or net sums.

When a data provider packet arrives whose Data Tag matches one of those in the **ValueDataTagx** parameters the value it contains will be placed in the **Valuex** parameter.

If data does not arrive from a module within the **Timeoutx** period then any reference to either the individual **Vx** tokens or one of the summing tokens will result in ----- rather than a numeric value.

The actual serial output can now be constructed using **Line1** to **Line25**. These parameters take text into which you can insert tokens. When a 'Print' is generated these lines are parsed and tokens replaced with the values they represent and the resulting data sent to the serial port.

A 'Print' is generated by either activating the switch input when **SwitchMode** is set to zero or by receiving a Data Provider packet whose Data Tag matches the **PrintDataTag** parameter. When a 'Print' is executed each of the parameters Line1 to Line 25 will be parsed. Every token will be evaluated and replaced with the live value.

---

## Getting Started

To associate transmitter modules with the T24-SO you must first ensure that the appropriate modules are transmitting their values at a suitable rate such as the default of 3 per second. Then you can configure the T24-SO module to use the data from these transmitters. Configuration must be done with the T24 Toolkit software and a base station.

Serial output is triggered by one of the following:

- The digital input (switch input) which may trigger an output/print or tare the summed value.
- Arrival of a data packet identified with a Data Tag that matches what the T24-SO uses to trigger an output/print.
- Arrival of a command to trigger an output/print or to tare or zero etc.

## T24 Toolkit

The T24 Toolkit provides a means of simple configuration of the T24-SO module along with useful tools to aid integration.

Launch the T24 Toolkit software application and pair to this module to enable the connection to the Toolkit to allow configuration to take place. [See Common Toolkit Pages - Home](#)

## Input Settings

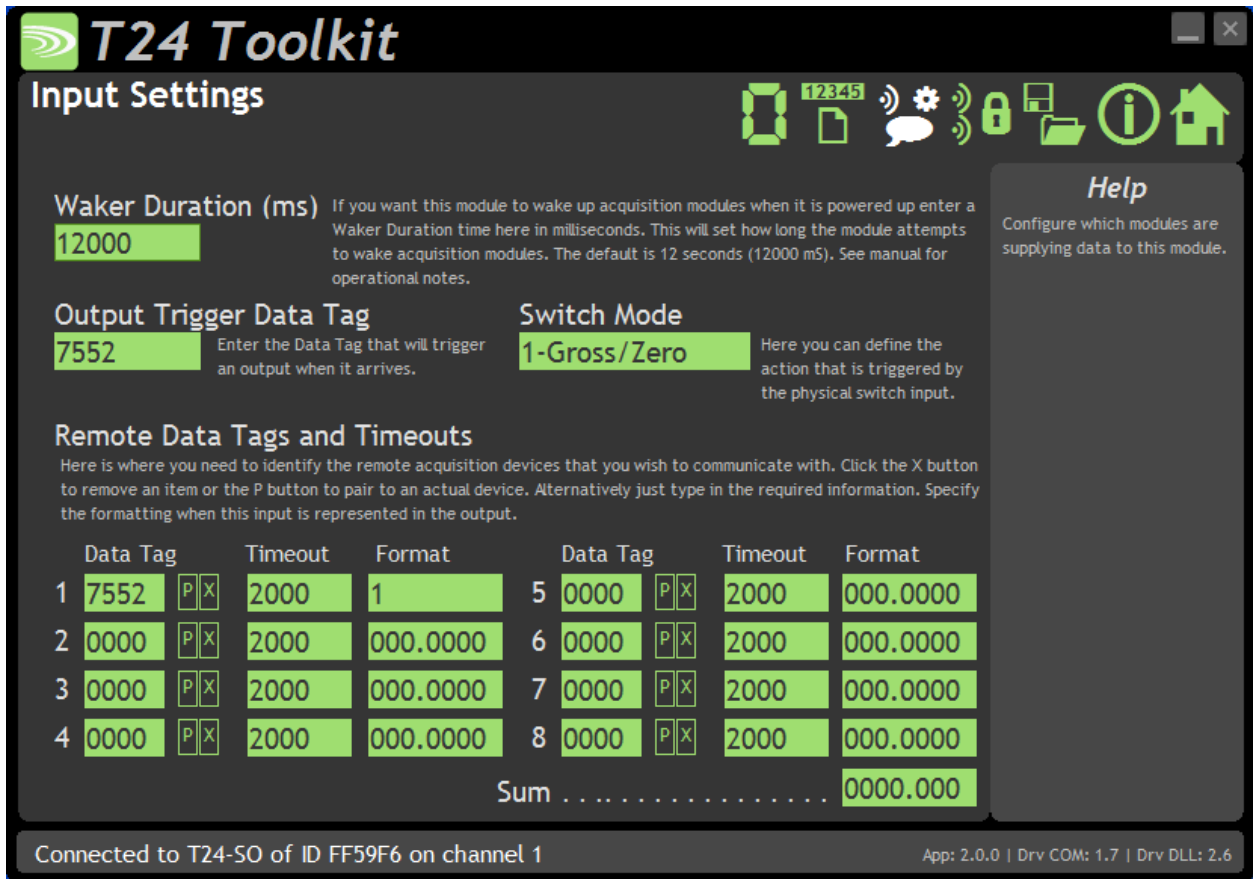

Here you can set the action to take when the switch contacts are closed, set the Data Tag that will trigger an output and also set the Data Tags of the data used as the inputs along with how the data is formatted.

### Items you can change:

Waker Duration

Enter the number of milliseconds the module will attempt to wake transmitter modules when it is first powered up. The default is 12000ms (12 seconds). Enter zero to disable this feature.

All transmitter modules on the same radio channel and sharing the same group key as the display module will be woken. Use the SleepDelay settings in the transmitter modules to let them return to sleep after the display module is switched off.

**i** This is only available for firmware versions 1.08 and above.

- Output Trigger Data Tag Enter the Data Tag which, on arrival, will trigger an output (i.e. print). Note that **Min Interval** setting on the Output Settings page may stop this from working at the rate at which the data arrives.  
This is usually set to the Data Tag of one of the inputs.  
**Example:** If the output was being sent to a serial display the same Data Tag would be assigned to input 1 and the output trigger so that each time data arrived the output would be sent to the serial display.
- Switch Mode Action to perform when switch contacts on J5 are closed. Click to select either:  
**Print** – Triggers an output from the serial port. Note that **Min Interval** setting on the Output Settings page may stop this from working at the rate the contact closes.  
**Gross/Zero** – Toggles the measurement mode between gross and net. When switching to net the net value is zeroed (tared). This will affect the value of the <N> token which is the net value of all summed inputs.

### Remote data Tags and Timeouts

Data Tag Enter the Data Tag (in hexadecimal) to supply data to this input.

**i** You can click the 'P' button to retrieve the Data Tag of a module by pairing to it which is usually initiated by power cycling the module.

Clicking the 'X' button zeroes the entered Data Tag.

Timeout Enter the timeout in milliseconds for this input. If a new Data Provider packet does not arrive within this time and reference to this input value (via token <V1> for example) will result in an output of -----. This also applies to a gross or net reading derived from this input.

Format Describe the format that this value is to take when output. You specify integer digits and decimal places by entering a format consisting of zeroes and decimal points. i.e. 00.000

**i** The integer value of data takes precedence over your defined format so if you defined a format of 0.0 and data of value 100.8265 arrived it would be represented as 100.8

#### Examples

Format	Value	Representation
0.0	1.2	1.2
0.0	100.8	100.8
00.000	6.1234	06.123
00.000	123.4567	123.456
0000.00	12.0	0012.00

#### Resolution

It is possible to set the resolution (the smallest unit of change) of the output results by including the numeric value in the format. i.e. 00.005 would only represent the value in steps of 00.005

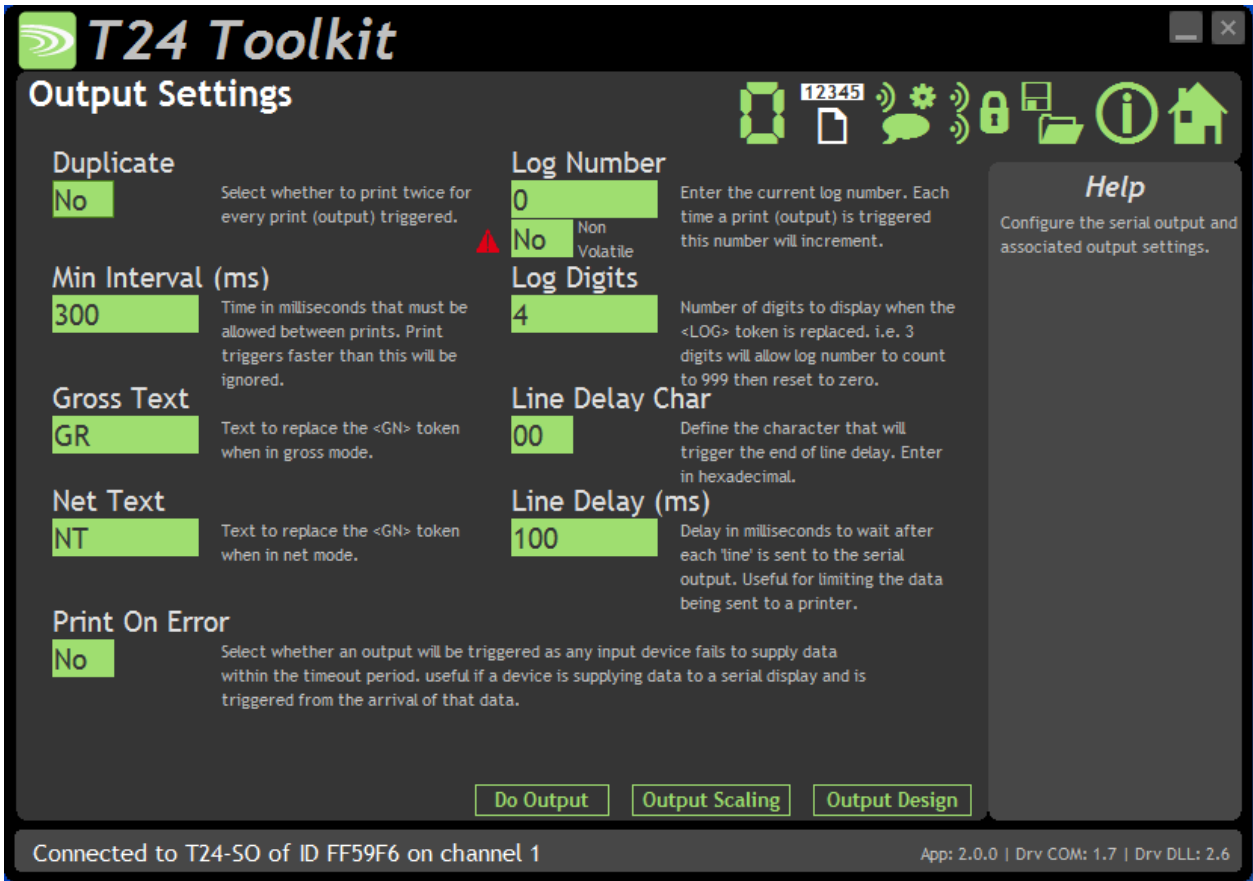

Here you can change various settings that influence the output from the module.

**Items you can change:**

- Duplicate** Whether to produce the same output twice each time an output is triggered. Useful, for example, with a printed output where a customer requires a receipt.
- Min Interval** Minimum time allowed between triggered outputs entered in milliseconds. Triggers arriving within this time since the previous trigger will be ignored. Example: A Data Tag is used to supply data to input 1 and is used to trigger an output. This data arrives at a rate of 50 per second but the output is connected to a serial display which would have problems if it were sent data at this rate. By setting the Min Interval to 300 the outputs would be limited to 3 per second even though the data was arriving at a higher rate.
- Gross Text** Enter text to replace the <GN> token with when the module is in gross mode.
- Net Text** Enter text to replace the <GN> token with when the module is in net mode.
- Print On Error** Whether to trigger an output when any input module fails to deliver new data within the timeout period. Example: Data arrives which is used as input 1. This same data tag is used to trigger an output which is sent to a serial display. Normally if the data fails to arrive the display would not get updated as no output would occur. By setting this property an output would be triggered when the data failed to arrive thus setting the serial display which would show ----- instead of the value when <V1> is decoded.

Log Number	Enter a log number that is used when the <LOG> token is decoded. Each time an output is triggered this log number is incremented. This number will wrap to zero once it reaches the maximum value displayable due to the Log Digits.
Log Number (Non Volatile)	<p>The Log number defaults to being volatile. Power cycling the T24-SO will revert the log number to the value seen on this page. This is ideal for when you have a fast output and you want the outputs to be numbered sequentially. i.e. with a fast output being sent to a data logger.</p> <p>Sometime it is required that the log number is Non Volatile, that is, the log number is restored each time the T24-SO is power cycled. This is useful when the output is used to drive a printer, for example, and the log number acts as a unique number on the customer ticket.</p> <p>When set to Yes the module must store the new Log Number each time it is incremented. This takes time and also uses up the finite write cycles of the internal flash memory. Therefore it is recommended that turning on the Non Volatile option is only done when the output (containing a &lt;LOG&gt; token) is triggered at 30 second intervals or less.</p>
Log Digits	<p>Set the number of digits to display when the &lt;LOG&gt; token is decoded. Example: If this is set to 2 then the log number will count up to 99 before resetting.</p>
Line Delay Char	<p>As the serial output has no hardware handshaking it is sometimes necessary to limit the rate at which the output is sent. This is most apparent with multiline outputs to a printer.</p> <p>Example: A printer requires a 0x0A (decimal 10) character (linefeed) to be sent at the end of each line to cause the printer to actually print the line. This character would be embedded in the actual designed output and the Line Delay Char set to 0A so each time a line is sent to the printer a delay occurs before the next part of the output is initiated. The delay is set by <b>Line Delay</b>.</p>
Line Delay	The delay in milliseconds that occurs when the Line Delay Character has been sent to the output.
<b>Buttons</b>	
Do Output	Trigger the output when clicked.
Output Scaling	Will display the Output Scaling page.
Output Design	Will display the Output Design page. This is where you define the output data.

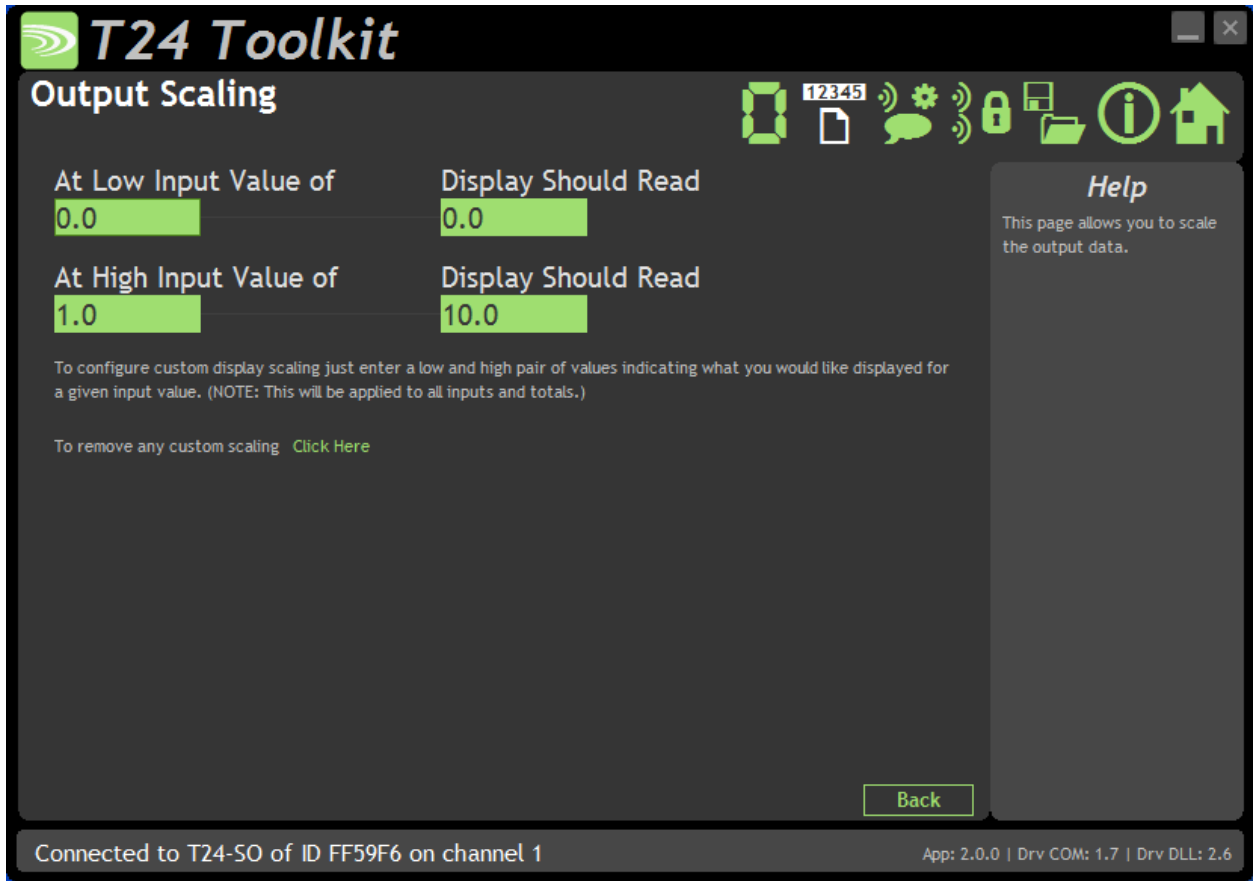

This page allows effective conversion between units. i.e. Although all modules supplying data are configured in kg you can get a printed output in lb.

**Items you can change:**

Custom Display Scaling

This can be used to change the displayed value to a different unit or to otherwise scale it. You simply enter the original and required values at a low and high point. Example: If a T24-SA was supplying data in kg and you wanted to show tonnes. You would keep both the low points at zero. Enter **At High Input Value** of 1000 and **Display Should Read** Value of 1.

**i** *This affects all inputs and sums (both gross and net). All tokens will effectively be decoded using the new scale factor.*



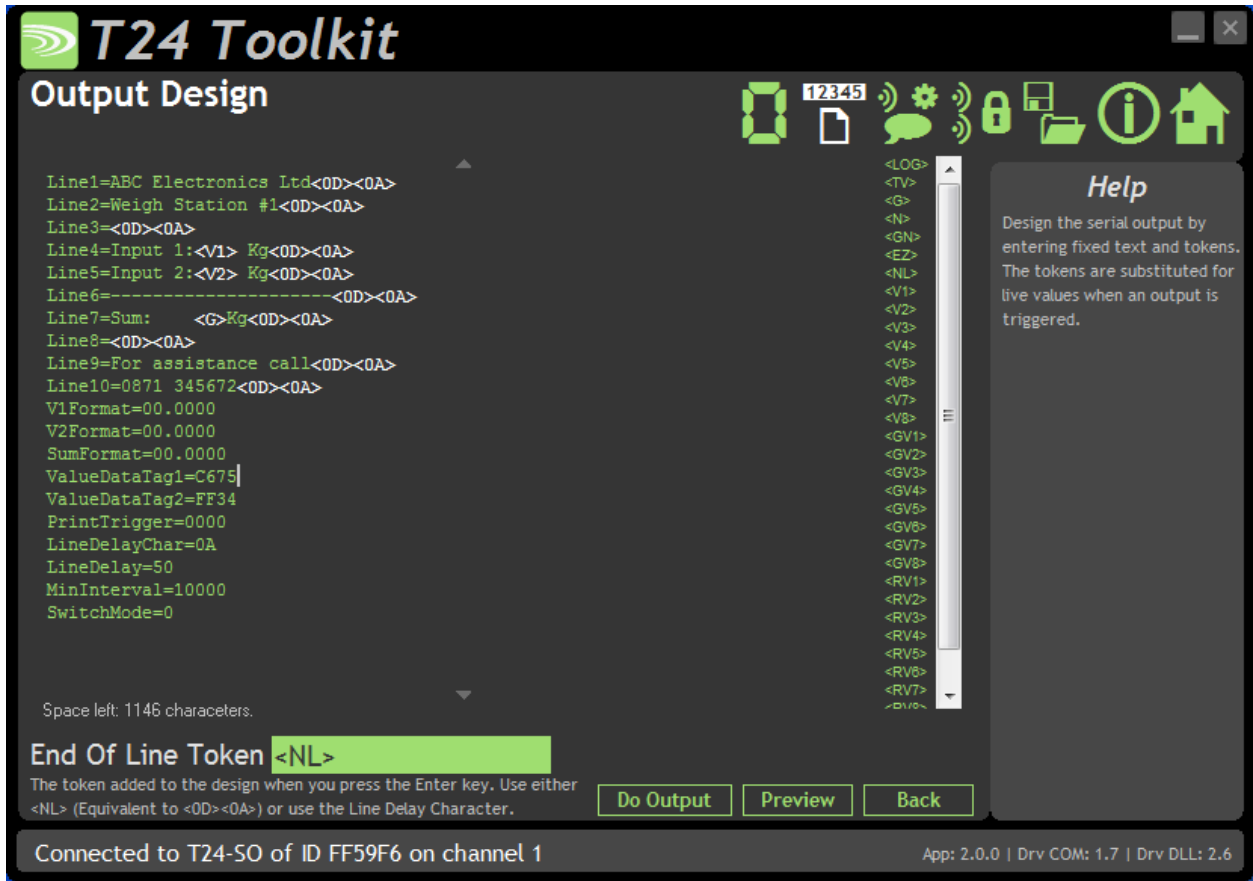

This is where you define the actual output based on free text and tokens. Tokens are special codes contained within angled brackets <token> which have special meanings and are converted to actual values once an output is triggered. See list of tokens at the bottom of this section.

**Items you can change:**

**End Of Line Token**

When you press the Enter key on the keyboard you need to know which token to include in the design area. For single line outputs this is not an issue but for multiline printer outputs for example it becomes important. You need to know what character is used to cause the printer buffer to be printed. For this you will need to refer to the printer manual. Some printers just require a Carriage Return <0D> and some may require a Line Feed <0A> or some may require both <NL>. You would need to set the Line Delay Char on the Output Settings page to the appropriate character. And here you can select whether to use that character each time Enter is pressed or you can opt for <NL>.

**Design Area**

This is where you create your output using a mixture of free text and tokens. See the example in the screenshot above. To enter a token you can type it in or double click the token list on the right of the page (a single click will display the description of the token).

## Available Tokens

Token	Function	Example
<V1> ... <V8>	Substitutes token with the last value received from the input. This will already have system zero subtracted (If a DoSysZero command has been issued.) and tare subtracted. (If a DoTare command has been issued or the switch input has executed a tare.)	1.2345
<GV1> ... <GV8>	Substitutes token with the last value received from the input. This will already have system zero subtracted (If a DoSysZero command has been issued.) but no tare subtracted. i.e. it will always contain the Gross value of the specified input.	1.2345
<RV1> ... <RV8>	Substitutes token with the last value received from the input. This will NOT have system zero or tare values subtracted.	1.2345
<TV>	Substitutes token with the value carried in the Data Provider packet that has triggered the 'Print'.	1.2345
<LOG>	Substitutes token with the log value. Each time a 'Print' occurs the log number will be incremented.	0003
<G>	Substitutes token with the Gross sum of all active inputs. System zero values will have been extracted.	1.2345
<N>	Substitutes token with the Net sum of all active inputs. System zeros will have been subtracted and also if a Tare has been issued then the tare value will be extracted.	1.2345
<EZ>	Substitutes token with the External System Zero.	1.2345
<GN>	Substitutes token with the GrossText or NetText parameter contents depending on the NetMode.	Gross
<xx>	Substitutes token with the ASCII character whose ASCII value is xx where xx is a two digit hexadecimal value. i.e. <0D>	ÆÖ-ü■

Below are listed some useful hex codes.

Hex Value Token	Description
<0D>	Carriage Return
<0A>	Line Feed
<09>	Tab
<1B>	Escape
<02>	STX
<03>	ETX



Here you can set a system zero.

**Items you can change:**

Perform System Zero

Clicking this will store the current values on all inputs and subtract the value from all subsequent outputs thus rendering the current input as zero. Example: A 4 input weigh platform will have calibrated transmitter modules but when the actual platform structure is in place each module has a weight value thus the gross value is 50kg. By performing a system zero (with all inputs operational) this is zeroed away so next time the T24-SO is powered on the same input will yield a zero result.

Remove System Zero

Clicking this will remove all system zeros and restore all outputs to normal.

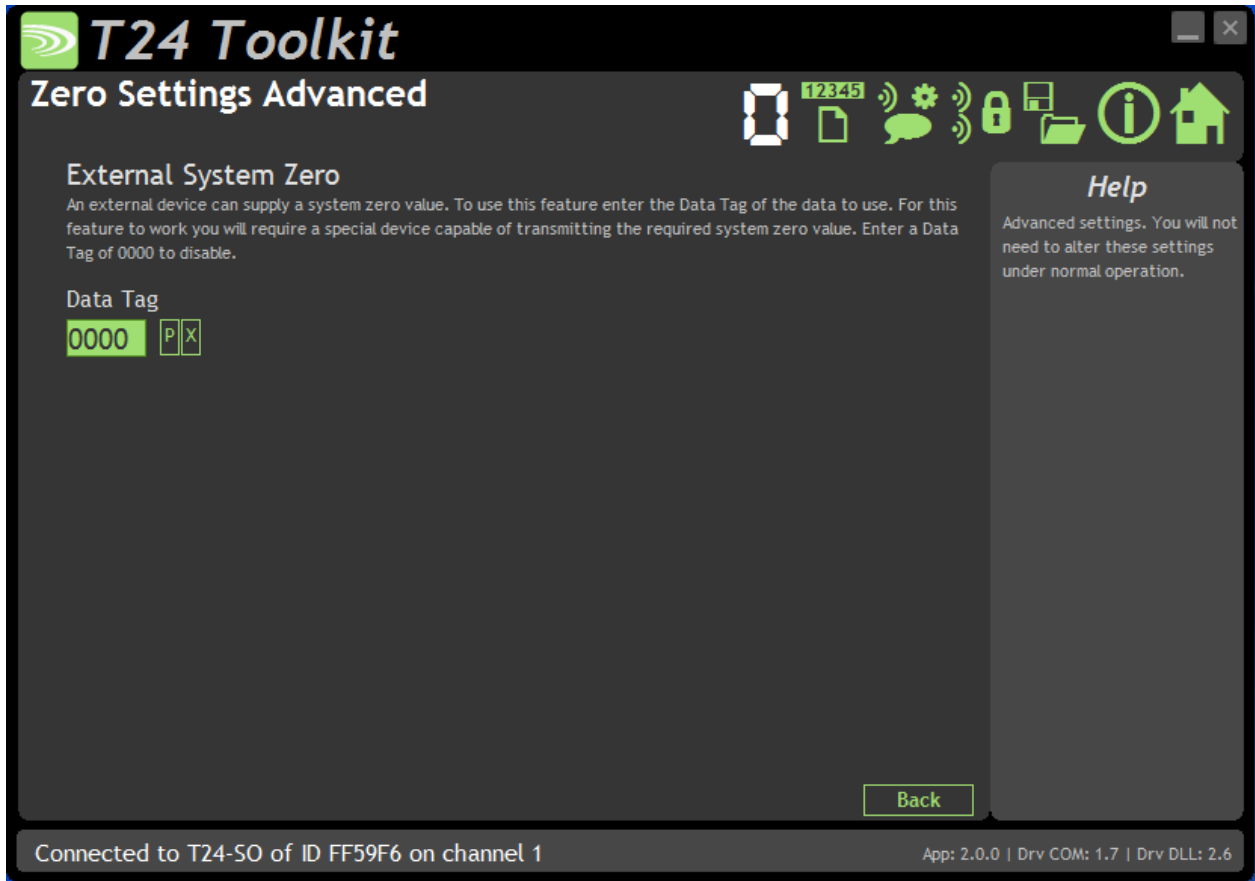

This advanced section allows the use of a specially configured external module to supply the system zero value for the handheld to use.

Example:

The same T24-SO is used with a truck that picks up different trailers and is required to display the sum of 4 strain gauges connected to each trailer (Using T24-SAs).

Because each trailer will have a different system zero requirement you would add a further module to each trailer set to transmit the system zero value. It is the Data Tag that is entered here.

On all trailers the transmitter module sets would share the same Data Tags.

**Items you can change:**

Data Tag Enter the **Data Tag** of the message to use for the external system zero.

ID Contains the ID of the module used to supply the external system zero. This is only necessary to provide a visible record of the remote module and is shown to keep compatibility with the **Mode and Communications** page.

You do not need to enter anything here although it will be filled in automatically if you perform a pair to retrieve data.

P Click this to give 5 seconds to perform pairing to automatically provide the Data Tag and ID from a specific module. Usually pairing is activated by removing and replacing the power supply.

X Click this to reset the Data Tag and ID to zero (disabling the external system zero function).

---

## Configuration Examples

---

### LED Display from a Single Source

We want to put data from a T24-SA onto a large LED display.

We will use the out of the box rate of 3 per second. The display only needs the ASCII data followed by a carriage return.

Assuming the T24-SA sends its data on Data Tag C675

```
Line1=<V1><0D>
V1Format=00.000
Timeout1=2000
ValueDataTag1=C675
PrintDataTag=C675
MinInterval=100
LineDelay=0
PrintOnError=1
SwitchMode=1
```

---

### Summed LED Display from Dual Source

We want to put the summed Net data from a pair of T24-SAs onto a large LED display. We want the switch input of the T24-SO to toggle between Gross and zeroed net mode. (The printed output will reflect whether the module is in gross or zeroed net mode).

We will use the out of the box rate of 3 per second. The display only needs the ASCII data followed by a carriage return.

Assuming the T24-SAs send data on Data Tag C675 and FF34

Parameter settings:

```
Line1=<NET><0D>
FormatSUM=00.000
ValueDataTag1=C675
ValueDataTag2=FF34
PrintTrigger=C675
MinInterval=100
LineDelay=0
PrintOnError=1
SwitchMode=1
```

## Print Gross Sum of Two Modules to Printer

We need to print the gross sum of 2 modules to a printer with each time the switch input is activated on the T24-SO.

We need to display the value of each input as well as the gross sum.

The printer is not very fast so we can only send a line every 50ms. Also we do not want to print more often than once every 30 seconds even if the switch is pressed. The printer requires a linefeed 0x0A at the end of each line.

We want the printed output to look like:

```
ABC Electronics Ltd
Weigh Station #1

Input 1: xx.xxxx kg
Input 2: xx.xxxx kg

-----
Sum:   xx.xxxx kg

For assistance call
0871 345672
```

Parameter settings:

```
Line1=ABC Electronics Ltd<0D><0A>
Line2=Weigh Station #1<0D><0A>
Line3=<0D><0A>
Line4=Input 1:<V1> kg<0D><0A>
Line5=Input 2:<V2> kg<0D><0A>
Line6=-----<0D><0A>
Line7=Sum:   <G>kg<0D><0A>
Line8=<0D><0A>
Line9=For assistance call<0D><0A>
Line10=0871 345672<0D><0A>
V1Format=00.0000
V2Format=00.0000
SumFormat=00.0000
ValueDataTag1=C675
ValueDataTag2=FF34
PrintTrigger=0000
LineDelayChar=0A
LineDelay=50
MinInterval=10000
SwitchMode=0
```

---

## Customer Ticket from Handheld Module

We have a handheld module T24-HA already configured to sum data from 4 modules. We want the F1 button on the handheld to trigger a printout to a serial printer connected to the T24-SO.

We only want to print the gross sum that the handheld passes us. The handheld is configured to send the Gross value as Data Tag **ABCD** when the **F1** button is pressed. This is referenced using the <TV> token (Trigger Value). The printer is not very fast so we can only send a line every 50ms. Also we do not want to print more often than once every 5 seconds even if the handheld tries to do so. The printer requires a carriage return 0x0D and linefeed 0x0A at the end of each line (So you can use <NL>).

We also want two tickets printed each time it is triggered.

We want the printed output to look like:

```
ABC Electronics Ltd
Weighment: xx.xxxx kg
```

Parameter settings:

```
Line1=ABC Electronics Ltd<NL>
Line2=Weighment: <TV> kg<NL>
SumFormat=00.0000
PrintTrigger=ABCD
LineDelayChar=OD
LineDelay=50
MinInterval=5000
Duplicate=1
```

---

## Enclosure & Mounting

This module is fitted inside our ACM ABS enclosure. Please see [Appendix A – Enclosures & Mounting – ACM](#) for more information.

---

## Antennas

These modules have the antenna already fitted inside the enclosure so there are no specific mounting requirements.

---

## Specification

Parameter	Min	Typical	Max	Units	Notes
External Supply voltage Range	9	12	32	Vdc	
USB Supply Range	4.875	5	5.125	Vdc	As defined by USB 2.0 Specification
Average Operational Current	-	100	-	mA	
USB Bus Powered Operational Current	100		200		
Operating Temperature Range	-20	-	55	°C	
Storage Temperature Range	-40	-	85	°C	
Reverse polarity Protection		-	-32	Vdc	Maximum Supply level
Humidity	0	-	95	%RH	
IP Rating		IP67			



*USB connector fitted to board is for power supply only.*

---

## Radio Range

To determine radio range please refer to [Appendix B – Antenna Range](#)



---

## T24-GW1

---

### Overview

The T24-GW1 is a gateway that provides a simple interface for users to gather serial data from up to 100 transmitter modules in a T24 network using either the standard Modbus RTU protocol or a simple ASCII protocol. Some simple commands are available to wake, sleep, and keep awake T24 transmitter modules.

The T24-GW will NOT act as a base station and cannot be used to configure T24 modules. It will support all transmitter modules that deliver a single value in their Data Provider packets. The T24-GW1 does not support the T24-SAf.

---

### Order Codes

---

#### T24-GW1



Gateway module in weatherproof enclosure.

---

## Connections

This diagram shows the available connections, switches and LEDs.

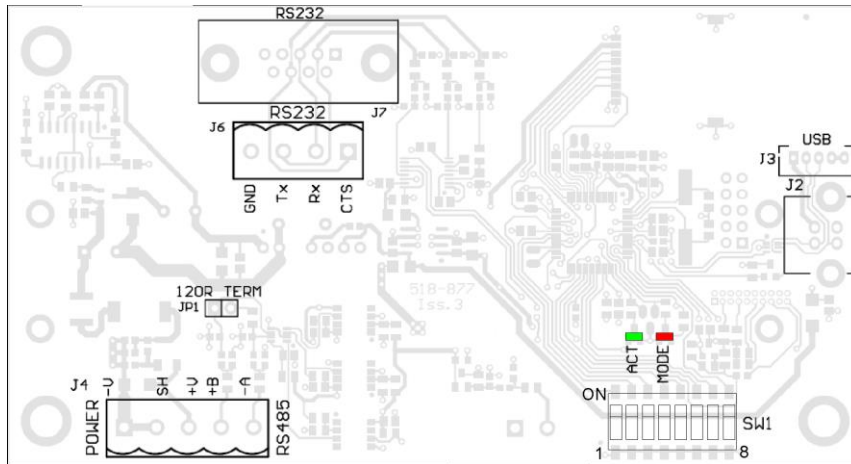

The interface baud rate can be selected from the DIP switches **SW1**.

---

## SW1 Settings

---

### Baud Rate

Switch positions 1 to 4 are not used and can be in any position.  
Switch positions 5 to 7 select the baud rate for the serial interface.

	5	6	7
<b>Baud rate / USB</b>			
<b>9600</b>	On	Off	Off
<b>19200</b>	Off	On	Off
<b>38400</b>	On	On	Off
<b>57600</b>	Off	Off	On
<b>115200</b>	On	Off	On
<b>230400</b>	Off	On	On
<b>460800</b>	On	On	On

Whether the serial interface is RS485 or RS232 is selected by switch position 8.

	8
<b>232/485</b>	
<b>RS232</b>	Off
<b>RS485</b>	On

---

## Power

The T24-GW1 requires an external power supply to be connected to J4 on the -V and +V pins.

---

## LED Indication

Two LEDs indicate Power/Mode and Activity.

The red LED indicates mode and should flash at a 2Hz rate. If any errors are detected with the radio then the LED will remain lit.

The green LED flashes once for each packet received via radio.

---

## RS232

The RS232 interface uses TX, RX and GND to connect to a PC, PLC etc. and uses standard RS232 voltage levels.

The baud rate can be selected by setting the DIP switches stated above.

**i** *The T24-GW1 will require power cycling to utilise a baud rate change.*

---

### Example connection to a PC 9 way D serial connector.

PC 9 Way D Plug Pin	Signal Direction	Signal	Base Station Connection
3 (TX)	->	RX	J6 RX or J7 Pin 3
2 (RX)	<-	TX	J6 TX or J7 Pin 2
5 (Gnd)		GND	J6 GND or J7 Pin 5
8 (CTS)	<-	CTS	J6 CTS or J7 Pin 8

---

## RS485

The RS485 interface (This is a 2 wire 485 interface and will not work with 4 wire 485 buses) uses TX, RX and GND to connect to a PC, PLC etc. and uses standard RS485 voltage levels.

The baud rate can be selected by setting the DIP switches stated above.

**i** *The T24-GW1 will require power cycling to utilise a baud rate change.*

---

### Example connection

Depending on the RS485 interface or hardware the connections vary and are not standard therefore we can only show the connections to the T24-GW1. You must refer to the user manual regarding your RS485 connection to ascertain the correct connections.

PC / PLC Connection	Signal	Base Station Connection
Refer to RS485 Device User Manual	A	J4 -A
Refer to RS485 Device User Manual	B	J4 +B
Refer to RS485 Device User Manual	GND	J4 SH

---

---

## Serial Limitations

- When using RS232 or RS485 you should use the fastest baud rate possible. At lower rates data can be lost because it can arrive from the radio faster than the gateway station can send it serially.

---

## Communications Overview

---

### MODBUS Communication

The T24-GW1 operates on Modbus RTU communication 8,N 1 ( 8 data bits, No Parity, 1 stop bit). The following Modbus Function codes are supported

- Function 03 'Read Holding Registers'
- Function 06 'Write Single Register'
- Function 16 'Write Multiple Registers'

The gateway has a single modbus address, 1 is the default address but this can be changed via register 41001 or via the T24-Toolkit.

---

### Control Registers

41001 – Read / Write

Set the MODBUS slave module ID, module ID will be 1 as default. Valid values 0-255.

41004 – Read / Write

Set to the T24 RF channel the gateway is working on. Valid values 1-15.

41005 – Read / Write

Set to the number of cells to be programmed into the table of data tags default = 0. Valid values 0-100

41006 – Read / Write

Set the Time out Value (seconds), if a channel does not update with in the timeout time the value register will be set to either the default value or last value received, see [Toolkit – General Settings](#). Valid values 0-255.

41007 – Read / Write

Set the Sleep time (seconds), this is the period for which the gateway will sleep any module it sees after the broadcast sleep register (41002) has been set to 1. The T24-GW1 will only sleep modules listed in the Data Tag registers. Valid Values 0-255.

41008 – Read / Write

This register Enables or disables the functionality to keep awake the modules specified in Data Tag Registers. Valid values 0 or 1.

---

### Commands

Writing a 1 to the following registers will execute the following commands:

41002 – Read / Write

Set to 1 to perform broadcast sleep to all modules, it will set back to zero when the sleep timer value has been reached.

41003 – Read / Write

Set to 1 to perform broadcast wake to all modules, it will set back to zero when the waker duration has been reached, the default waker duration is 12 seconds but can be set using the T24-Toolkit, see [Toolkit – General Settings](#).

41009 – Read / Write

Set to 1 to perform module save to save all the current settings and data tags in the module. It will set back to zero once the save is complete.

## Data Tag Holding Registers

41100 - 41199 – 100 registers containing the unique data tags of the modules to be read from. Each data tag is a 2 byte HEX code unique to each transmitter module. The data tag registers can be written to individually and as a block. These are the same data tags that can be configured via the T24-Toolkit

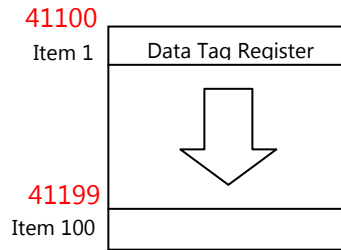

## Value & Status Registers

41500 - 41799 – 300 registers containing the values from each transmitter module as well as the status and LQI (Link Quality Indicator). The 4 Byte floating point values from each transmitter module are contained within two consecutive registers followed by a single register containing the LQI and status of the same transmitter modules. The data tag registers and value registers correspond such that the values and status from the data tag specified in register 41100 are contained within 41500 to 41502 and the value and status for the data tag specified in register 41199 are contained within registers 41797 to 41799.

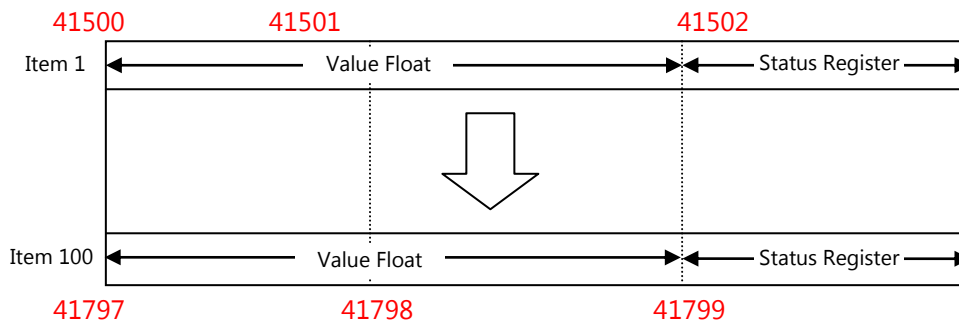

When reading registers containing the floating point data the register pairs must be read at the same time otherwise incorrect values could result because of partial updates during reading.

The two register presents a numeric value from n to n and consist of a 4 byte 32 bit float in IEEE 754 format.

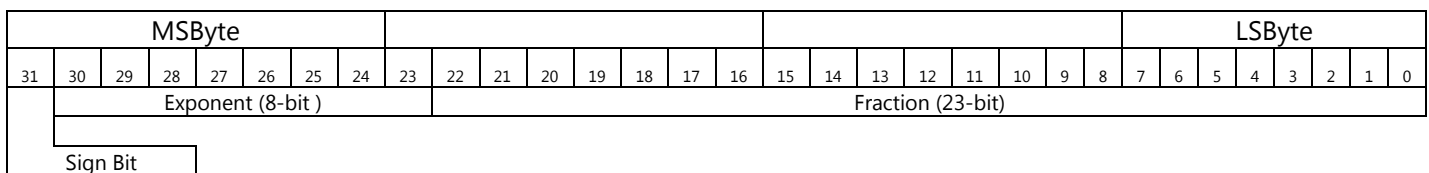

The byte containing the sign and exponent is sent first, with the LS byte of the mantissa being last. The value of the number is thus

$$(-1)^{\text{Sign}} * 2^{(\text{Exponent}-127)} * 1.\text{Mantissa}$$

Note the 'assumed 1' before the mantissa. The exception to this is the special value 0.0, which is represented as 4 zeroes.

The precision of this format is to 7 digits.

eg. a floating-point number of -12345.678 is represented as – [hex] C640E6B6

The order in which the Bytes are presented can be changed from MSB (as above) to LSB using the Modbus Data Format setting in the T24 toolkit, see [Toolkit – General Settings](#).

The status register contains the status byte, LQI and Time Out indicator in the format shown below:

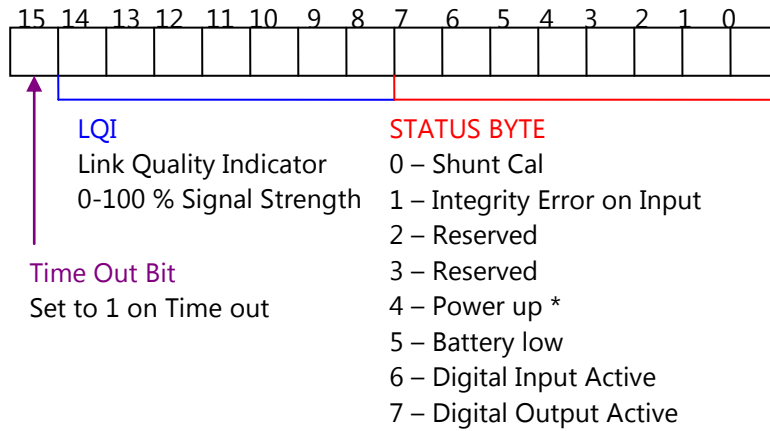

\* - This flag is set if the module has had power interrupted i.e. is running due to battery change

## ASCII Communication

The T24-GW1 ASCII mode provides a very simple interface for gathering data from T24 modules. When a packet is received from any transmitter module on the same RF channel an ASCII string is sent from the gateway in the format:

DataTag=Value,LQI,B,E <CR>

DataTag – The four digit data tag of the module that the reading has come from

Value - an ASCII representation of the module reading

LQI – Link quality indicator between 0 – 100

B – Set to 1 if low battery error

E – Set to 1 if integrity error

Example: FE56=123.156,100,0,0 <CR>

---

## Commands

Sending ASCII commands to the gateway will cause the gateway to handle the request but no feedback on the result is available. The commands will act on all transmitter modules on the same RF channel and group key as the gateway.

SLEEP <CR> - Sleep all modules that data providers are received from for the sleep duration period. The sleep duration is set in the T24-Toolkit, see [Toolkit – General Settings](#).

WAKE <CR> - Wake all modules that request to wake for the wake duration period. Sleeping transmitter modules transmit wake requests every 5 seconds. The wake duration is set in the T24-Toolkit, see [Toolkit – General Settings](#).

STAYAWAKE <CR> - Issue a stay awake packet to all modules seen for 5 seconds following this command being executed.



*When using RS485 interface issuing commands while the T24-GW1 is outputting is not possible as the RS485 bus is only half duplex*



---

## Configuration

The T24 Toolkit provides a means of simple configuration of the gateway module along with useful tools to aid integration.

Launch the T24 Toolkit software application and pair to this module to enable the connection to the Toolkit to allow configuration to take place. [See Common Toolkit Pages - Home](#)

---

## General Settings

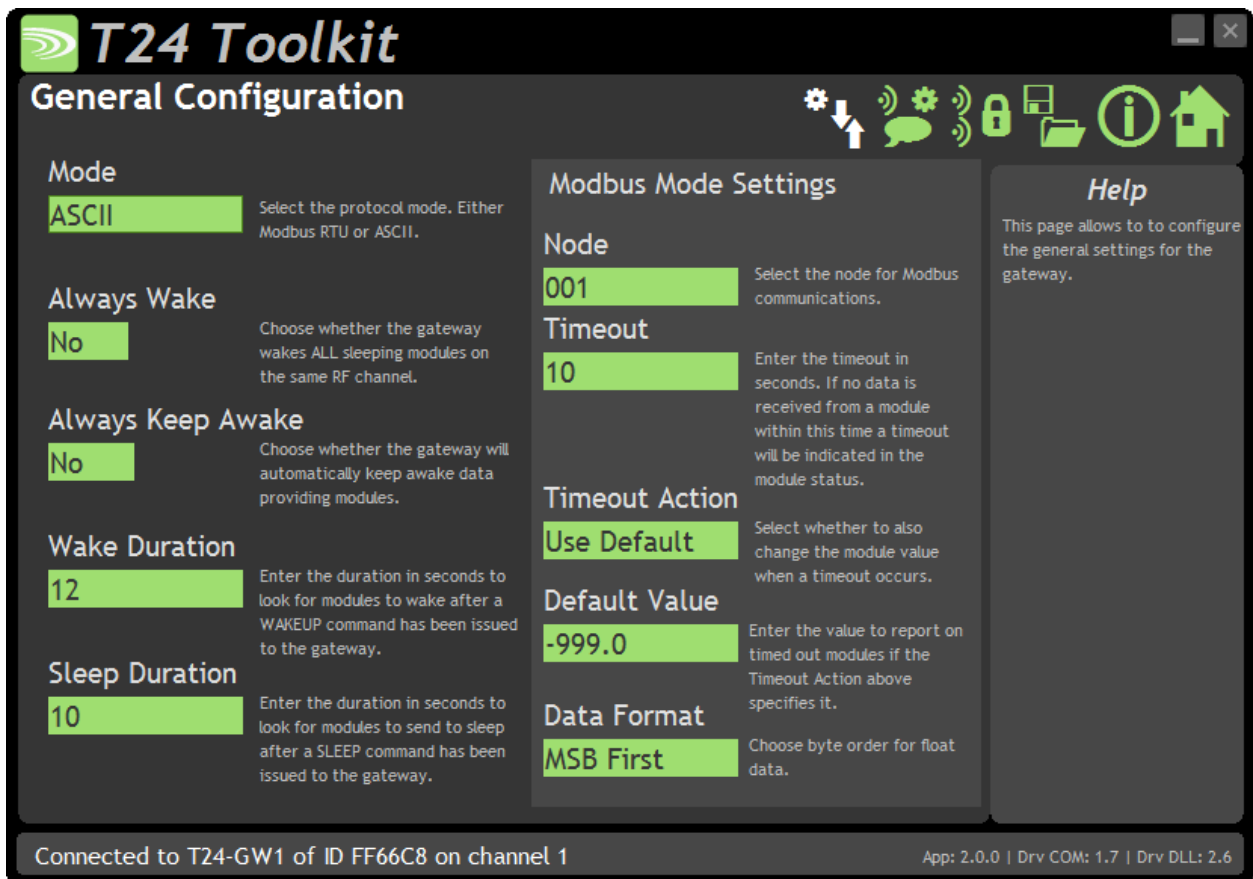

Here you can set how the module is configured to operate.

### Items you can change:

Mode	Defines which serial interface the gateway is operating on. <ul style="list-style-type: none"><li>• Modbus</li><li>• ASCII</li></ul>
Always Wake	If set to Yes the gateway will wake ALL sleeping modules on the same RF channel and group key as the gateway module.
Always Keep Awake	If set to Yes the gateway will automatically keep awake data providing modules.
Wake Duration	The duration in seconds to look for modules after a WAKEUP command has been issued.
Sleep Duration	The duration in seconds to look for modules to send to sleep after a SLEEP command has been issued.

## **MODBUS ONLY Settings**

Node	Is the MODBUS station number or node address of the T24-GW1
Timeout	The time in seconds that if no data is received from a module the gateway will indicate as timed out.
Timeout Action	Defines what value will be reported in the register when a timeout occurs. <ul style="list-style-type: none"><li>• Use Default – the value specified as default value will be reported.</li><li>• Use Last Value – the last value received from the module will be reported</li></ul>
Default Value	This is the value that will be reported in the MODBUS register if a transmitter module has timed out AND the Timeout Action is set to Use Default.
Data Format	In Modbus mode the data from the value register can be displayed in two formats: <ul style="list-style-type: none"><li>• MSB – Most Significant Byte First</li><li>• LSB – Least Significant Byte First</li></ul>

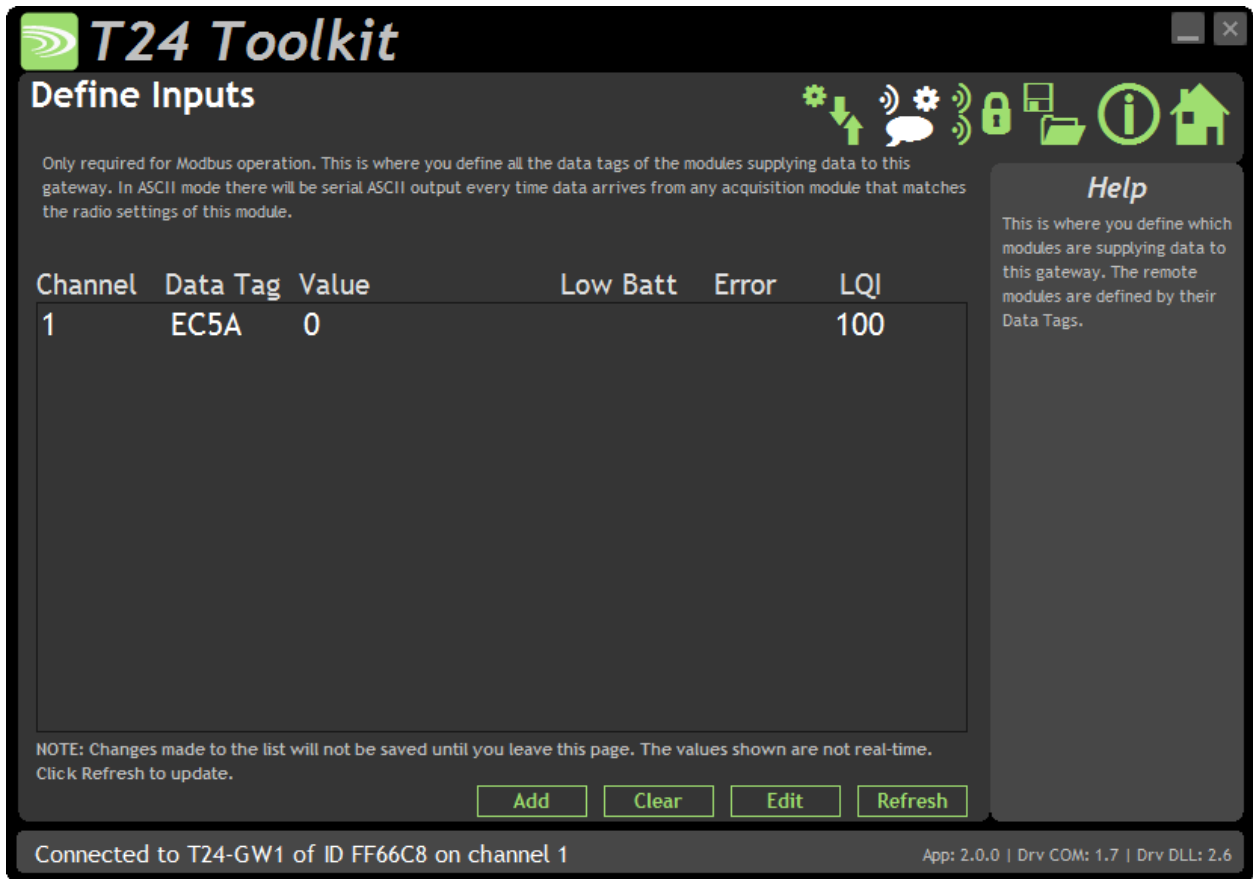

This is where you define which transmitter modules are to be providing data to this module when in Modbus mode.

You can add the channels by entering the Data Tag of the transmitter modules you want to receive data from. The list will show the last value delivered by each channel or the word **Timeout!** if no data has arrived for longer than the T24 Timeout setting.

The LQI (Link Quality Indicator) provides a measurement of the RF reception for the last packet received from each input. The Low Batt and Error marks display if a module has a low battery or integrity alert.

**Items you can change:**

- Add Button                                      Clicking this will allow you to specify a new Data Tag to add.
- Clear Button                                      This clears ALL the currently configured channels.
- Edit Button                                        Changes the display to show a simple list of Data Tags. This allows quick bulk entry of tags from an external source. You can simply paste a list of tags into the list or type them manually.
- Refresh Button                                    Refreshes the list.

*When using this page ensure you are in Modbus mode for values to be updated live.*

---

## Enclosure & Mounting

This module is fitted inside our ACM ABS enclosure. Please see [Appendix A – Enclosures & Mounting – ACM](#) for more information.

---

## Antennas

These modules have the antenna already fitted inside the enclosure so there are no specific mounting requirements.

---

## Specification

Parameter	Minimum	Typical	Maximum	Units
External Supply voltage Range	9	12	32	Vdc
Average Operational Current	-	100	-	mA
Operating Temperature Range	-20	-	55	°C
Storage Temperature Range	-40	-	85	°C
Reverse polarity Protection		-	-32	V
Humidity	0		95	%RH
IP Rating		IP67		

---

\* At 12 Volt nominal Supply

---

## Radio Range

To determine radio range please refer to [Appendix B – Antenna Range](#)

---

## T24-LD1

---

### Overview

The T24-LD1 provides the user with a large format four-digit display capable of displaying the summed value of up to eight T24 wireless telemetry transmitter modules.

The T24-LD1 only requires the connection of an 11-30 Vdc power supply (not supplied).

When installed correctly the unit conforms to IP65/NEMA4X.

Using the PC based T24 Toolkit software and a USB base station the user can quickly and easily select and configure the transmitter modules to be summed on the T24-LD1. The T24 Toolkit also provides advanced user control over the wireless aspects of the system as well as a 'System Zero' function.

Further wired Logic Inputs allow the user to remotely control Tare and Net/Gross toggle functions.

---

### Order Codes

---

#### T24-LD1



Large LED display module

## Connections

To access the connections the rear panel should be removed.

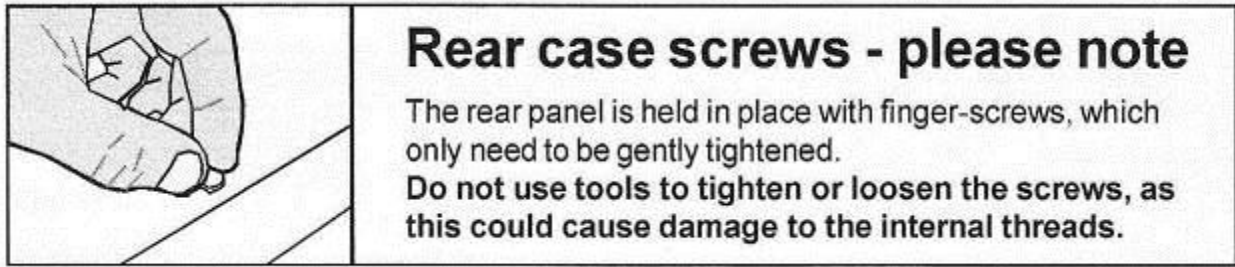

The T24-LD1 should be connected to an 11–30VDC external power supply capable of supplying 3.5 amps as below:

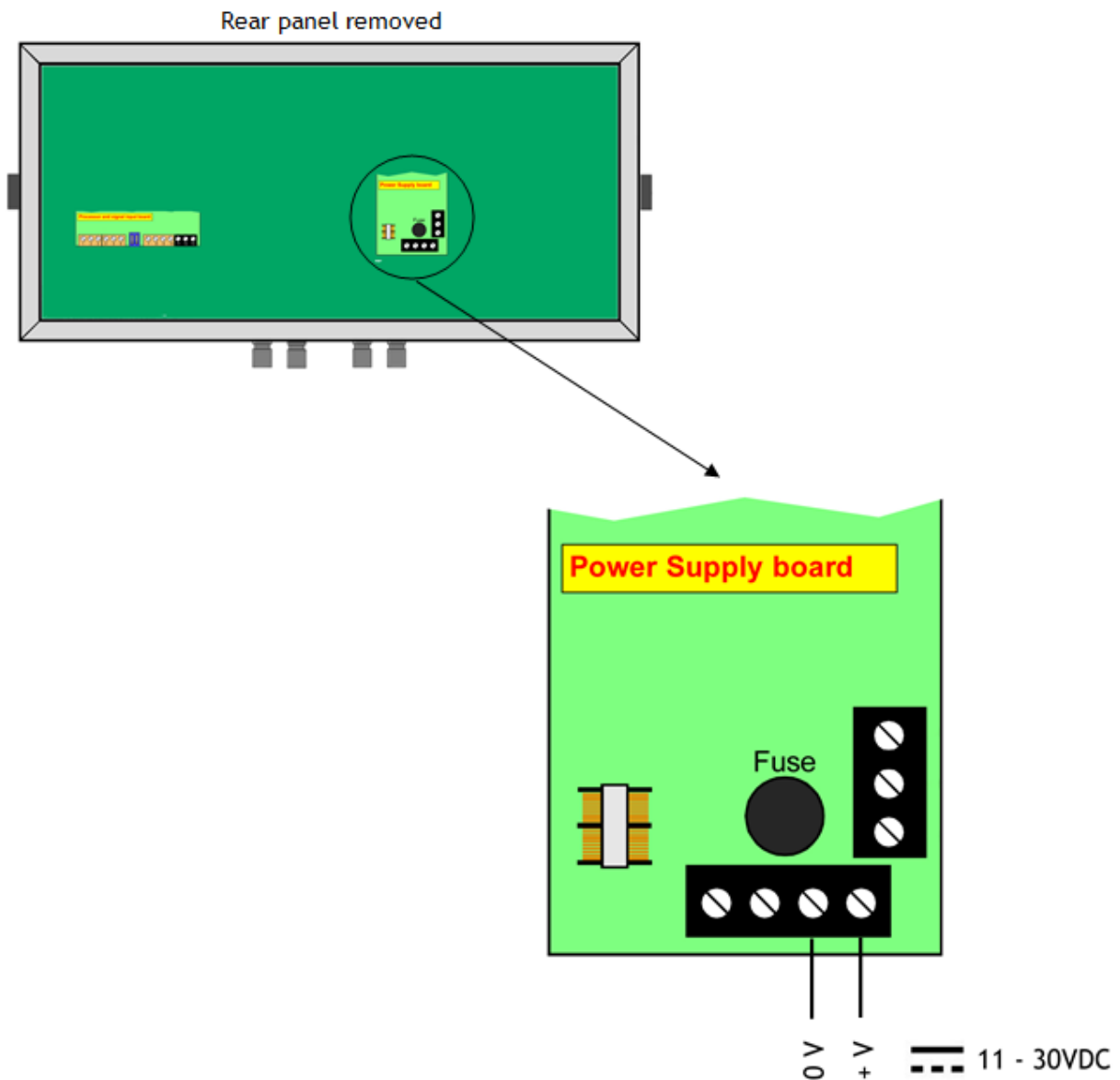

## Logic Input Connections

It is not necessary to connect to the logic inputs unless you require the enhanced functionality they provide.

The two contact closures inputs are pre-configured to provide the following functionality:

**Contact Closure 1 = Tare**

**Contact Closure 2 = Net/Gross Toggle**

**i** When the Tare contact is closed the display will show zero and the display mode will be switched to Net.

The logic input provides a 5 Vdc signal. When connected to this common, a current of 1mA will flow. Because this is a small signal only switches with gold contacts or self-cleaning contacts are recommended.

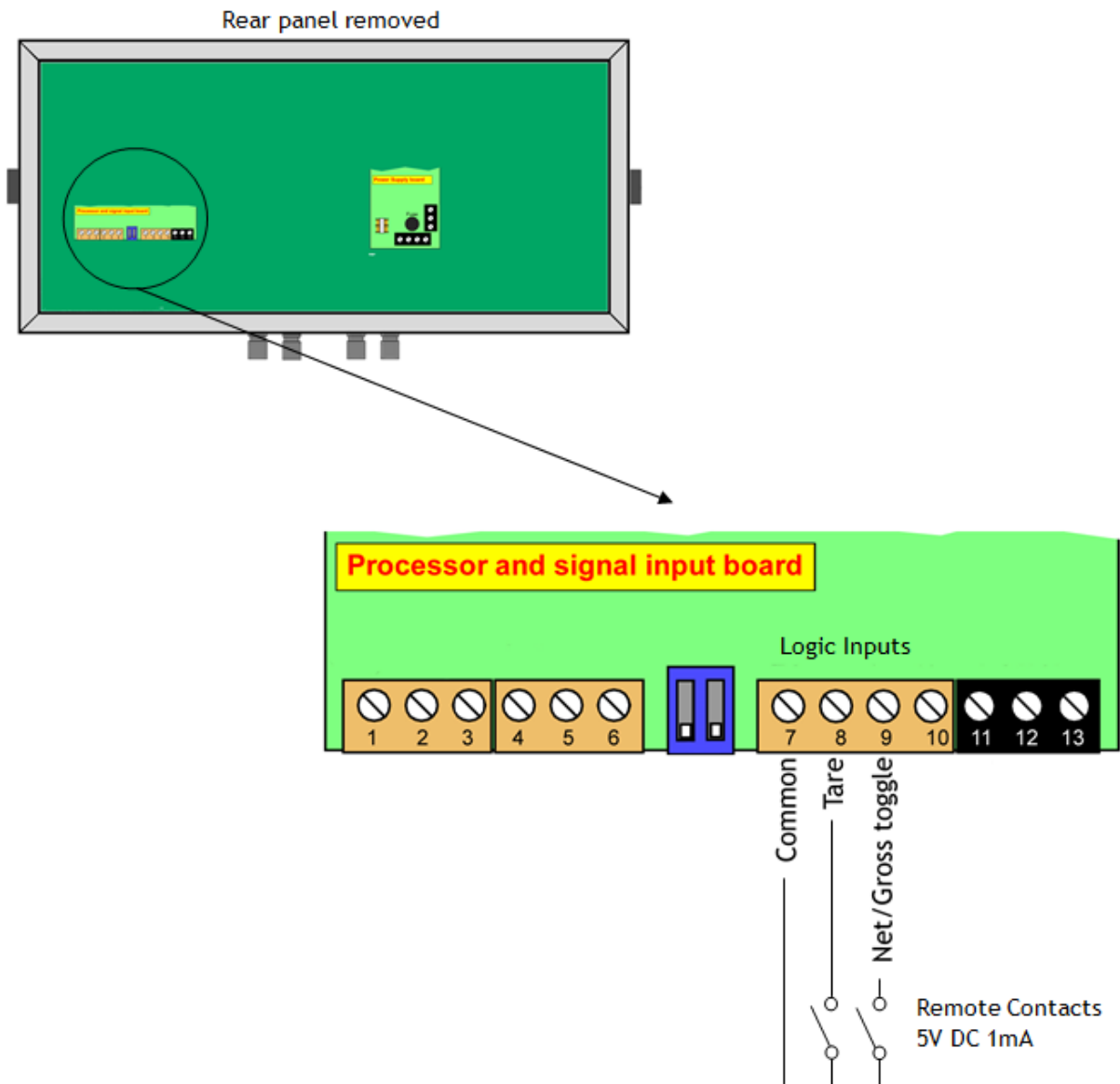



## Logic Input Front Panel indicators

If the logic inputs are not used this LED will not be lit.

When the logic inputs are activated the front panel indicator lamps display the following:

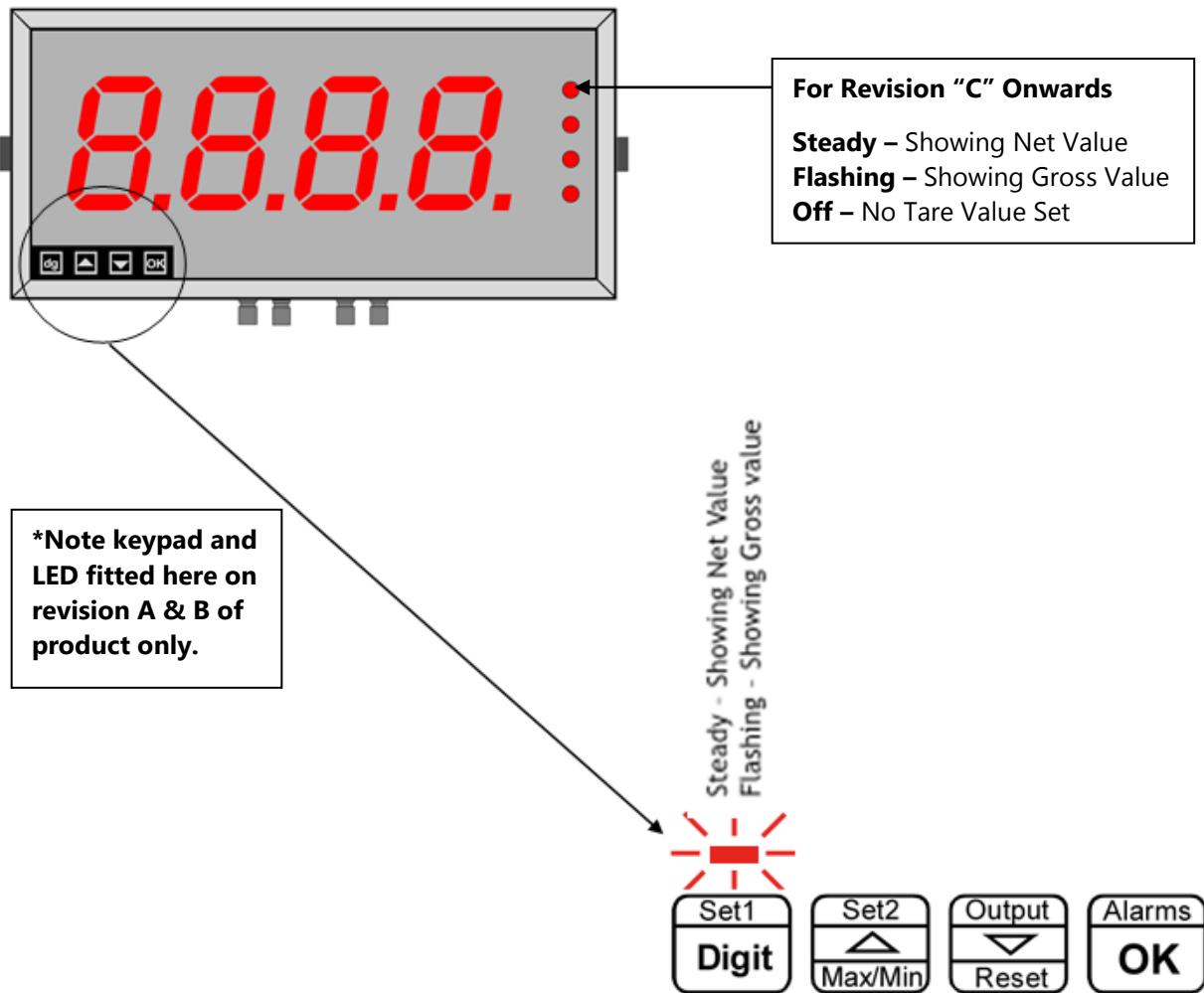

## Configuration

The T24 Toolkit provides a means of simple configuration and calibration of the transmitter module along with useful tools to aid integration.

Launch the T24 Toolkit software application and pair to this module to enable the connection to the Toolkit to allow configuration to take place. [See Common Toolkit Pages - Home](#)

## Input Settings

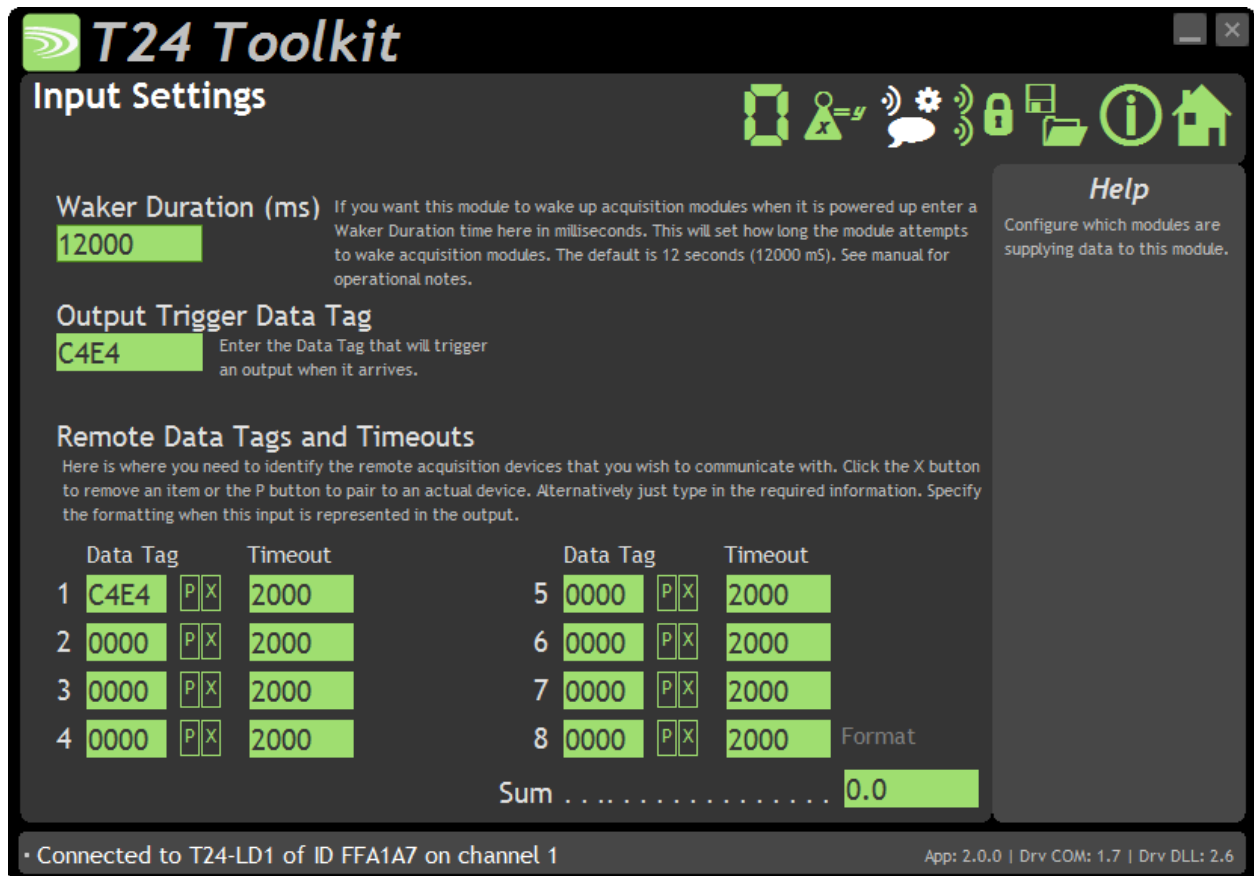

Use this page to enter the Data Tags of the T24 transmitter modules to be summed and displayed on the T24-LD1. The user can also set the Data Tag that will trigger a display output along with how the data is formatted.

### Parameters:

Waker Duration

Enter the number of seconds the display module will attempt to wake transmitter modules when it is first powered up. Enter zero to disable this feature. All transmitter modules on the same radio channel and group key as the display module will be woken. Use the SleepDelay settings in the transmitter modules to let them return to sleep after the display module is switched off.

Output Trigger Data Tag

Enter the Data Tag which, on arrival, will trigger a display output. This is usually set to the Data Tag of one of the inputs. **For single transmitter module displays the Data Tag of that transmitter module should be entered here and as the first item in the Remote Data Tags and Timeouts section.**

### Remote Data Tags and Timeouts

Data Tag

Enter the Data Tag (in hexadecimal) to supply data to this input. You can click the 'P' button to retrieve the Data Tag of a module by pairing to it which is usually initiated by power cycling the module.

P Click this to give 5 seconds to perform pairing to automatically provide the Data Tag and ID from a specific module. Usually pairing is activated by removing and replacing the power supply.

X Click this to reset the Data Tag to zero

Timeout Enter the timeout in milliseconds for this input.  
Recommended to be set at 3 x Transmission interval of transmitter module. If a new Data Provider packet does not arrive within this time this will result in an output of - - - -.

Format Describe the format that this value is to take when output. Specify integer digits and decimal places by entering a numeric format consisting of zeroes and decimal points. i.e. 00.00

The selection of the format determines the range of values that the module can display.

Format	Minimum Displayable Value	Maximum Displayable Value
0	-1999	9999
0.0	-199.9	999.9
0.00	-19.99	99.99
0.000	-1.999	9.999

**If the value to display is below the minimum displayable value then –Ur- will be displayed.**

**If the value to display is above the maximum displayable value then –Or- will be displayed.**

**T24 Toolkit**  
**Output Scaling**

At Low Input Value of  Display Should Read

At High Input Value of  Display Should Read

To configure custom display scaling just enter a low and high pair of values indicating what you would like displayed for a given input value. (NOTE: This will be applied to all inputs and totals.)

To remove any custom scaling [Click Here](#)

**Help**  
This page allows you to scale the output data.

Connected to T24-LD1 of ID FFA1A7 on channel 1 App: 2.0.0 | Drv COM: 1.7 | Drv DLL: 2.6

Use this page to scale the data displayed on the T24-LD1. This may be used, for example, to convert the data from a transmitter module calibrated in kg so that the T24-LD1 display shows the value in tonnes.

**Parameters:**

Output scaling

This can be used to change the displayed value to a different unit or to otherwise scale it. You simply enter the original and required values at a low and high point. Example: If a Transmitter module was supplying data in kg and you wanted to display in tonnes. You would keep both the low points at zero. Enter **At High Input Value** of 1000 and **Display Should Read Value** of 1.



Use this page to set a system zero.

**Parameters:**

Perform System Zero

Clicking this will store the current values on all inputs and subtract the value from all subsequent outputs thus rendering the current input as zero. Example: A 4 input weigh platform will have calibrated transmitter modules but when the actual platform structure is in place each module has a weight value thus the gross value is 50kg. By performing a system zero (with all inputs operational) this is zeroed away so next time the T24-LD1 is powered on the same input will yield a zero result.

**i** This does not affect the data transmitted from the transmitter modules.

Remove System Zero

Clicking this will remove all system zeros and restore all outputs to normal.

Advanced Button

Show the Zero Settings Advanced page.



This advanced section allows the use of a specially configured external module to supply the system zero value.

**Parameters:**

Data Tag Enter the **Data Tag** of the message to use for the external system zero.

P Click this to give 5 seconds to perform pairing to automatically provide the Data Tag and ID from a specific module. Usually pairing is activated by removing and replacing the power supply.

X Click this to reset the Data Tag and ID to zero (disabling the external system zero function).

## Enclosure & Mounting

The T24-LD1 is designed for wall or suspension mounting.

### Suspended

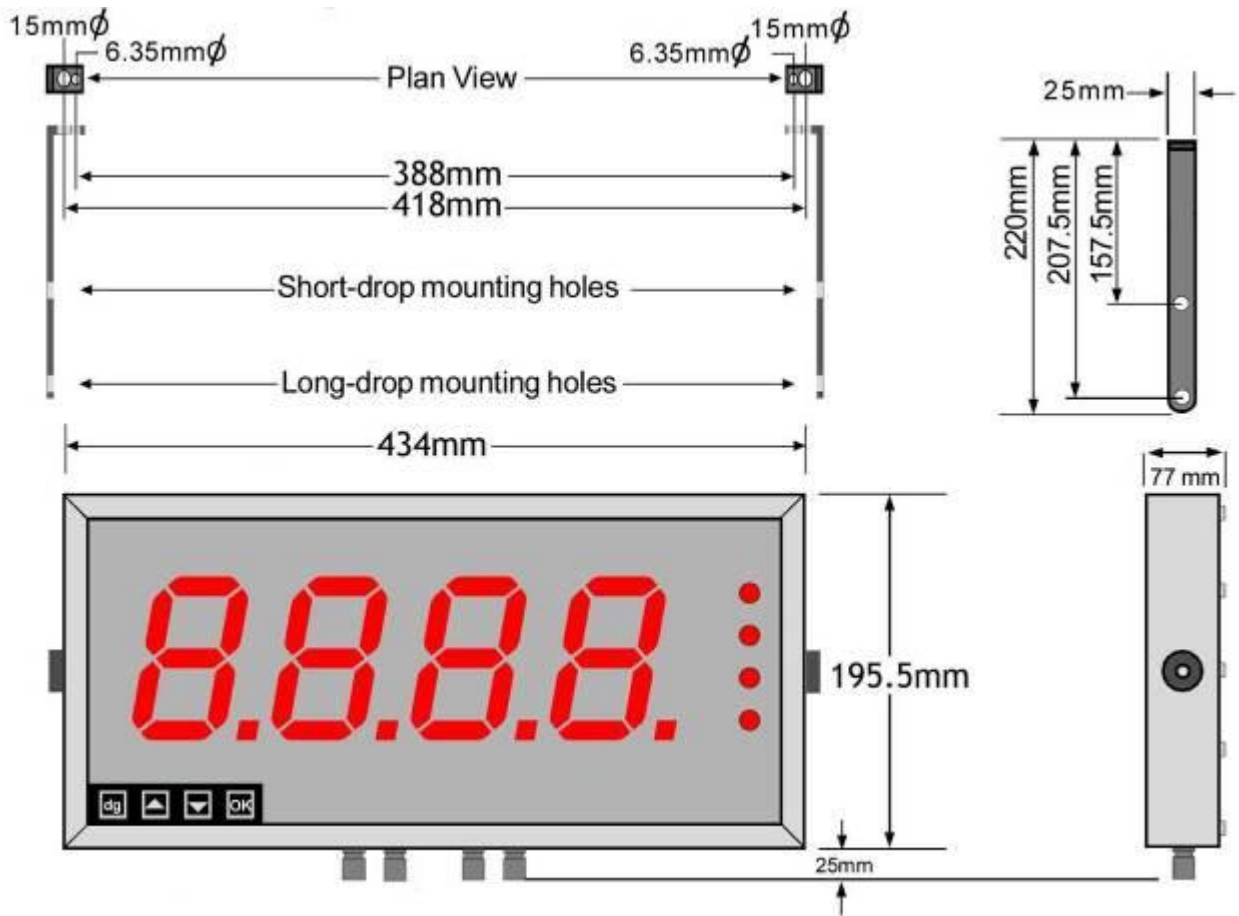

Detail showing bracket hardware fitting sequence:

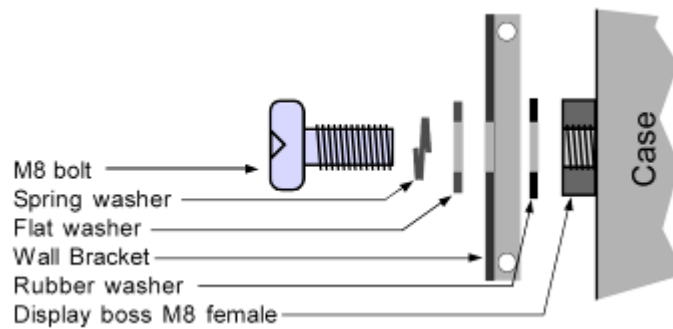

### Wall Mounted

**It is recommended that the T24-LD1 module is mounted at a higher elevation than the transmitter modules as the antenna is located on the lower face of the display (Where the cable access glands are located).**

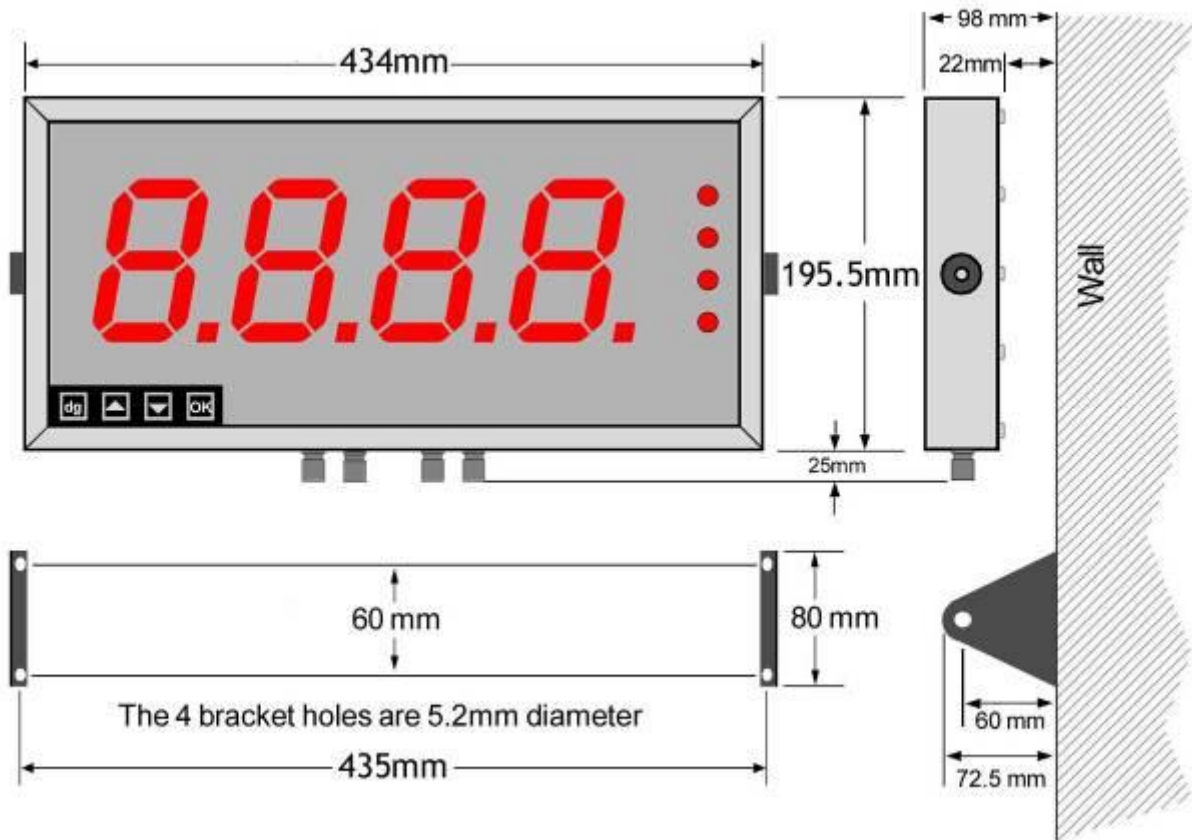

Detail showing bracket hardware fitting sequence:

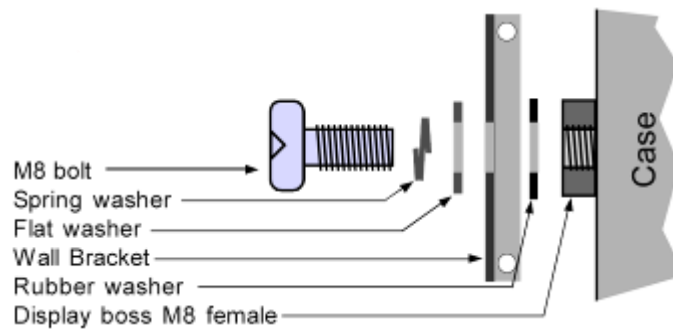

## Antennas

These modules have the antenna already fitted inside the enclosure so there are no specific mounting requirements.



---

## Specification

Parameter	Minimum	Typical	Maximum	Units	Notes
External Supply voltage Range + Reverse Polarity Protection	11		30	Vdc	
Maximum Operational Current	-		3.5	A	
Operating Temperature Range	0	-	50	°C	
Storage Temperature Range	-20	-	70	°C	
Humidity	0	-	95	%RH	
IP Rating		IP65			

---

## Radio Range

To determine radio range please refer to [Appendix B – Antenna Range](#)

---

## T24-PR1

---

### Overview

The T24-PR1 is a thermal printer module that can print a 57 mm wide ticket which can include data from up to 8 modules and optionally sum them. The printout can be triggered from the arrival of data from a specific module or alternatively by a handheld module which can also optionally supply the data value to print.

**i** *Print triggering from an external button/switch option will be made available on future releases of the T24-PR1.*

The actual printed output can be designed by the user using multiple lines which can include free text or tokens which can represent real data. i.e. <V1> would be decoded as the value from input 1 when the print is triggered or <TV> would reference the Trigger Value from an external handheld for example.

---

### Order Codes

---

#### T24-PR1



The printer module is housed in a non-sealed enclosure.

---

### Connections

---

#### Power

You will need to connect a power supply to the T24-PR1 for it to operate and to enable configuration using a base station and the appropriate toolkit software.

Power is supplied via a 2.5 mm DC plug which plugs into, and locks with, a 2.5 mm socket on the side of the module. Voltage range is 9 to 36 Vdc and requires approximately a one Ampere (1A) capable supply.

The tip of the connector is positive.



---

## Configuration

Once it has been determined how many modules are feeding data to this module you need to record the Data Tag that each of these modules are attaching to their Data Provider packets. These Data Tags are then entered into the **ValueDataTagx** parameters. Once the rate at which this data arrives is known you can enter the **Timeoutx** values. Leave unused **ValueDataTagx** parameters with a value of zero to ensure that they are not checked for timeouts and do not contribute to gross or net sums.

When a data provider packet arrives whose Data Tag matches one of those in the **ValueDataTagx** parameters the value it contains will be placed in the **Valuex** parameter.

If data does not arrive from a module within the **Timeoutx** period then any reference to either the individual **Vx** tokens or one of the summing tokens will result in ----- rather than a numeric value.

The actual serial output can now be constructed using **Line1** to **Line25** (In the toolkit these are hidden and the user simply creates the ticket on screen). These parameters take text into which you can insert tokens. When a 'Print' is generated these lines are parsed and tokens replaced with the values they represent and the resulting data sent to the serial port.

A 'Print' is generated by either issuing a DoPrint command, activating the switch input when **SwitchMode** is set to zero or by receiving a Data Provider packet whose Data Tag matches the **PrintDataTag** parameter. When a 'Print' is executed each of the parameters Line1 to Line 25 will be parsed. Every token will be evaluated and replaced with the live value.

The T24 Toolkit provides a means of simple configuration of the module along with useful tools to aid integration.

Launch the T24 Toolkit software application and pair to this module to enable the connection to the Toolkit to allow configuration to take place. [See Common Toolkit Pages - Home](#)

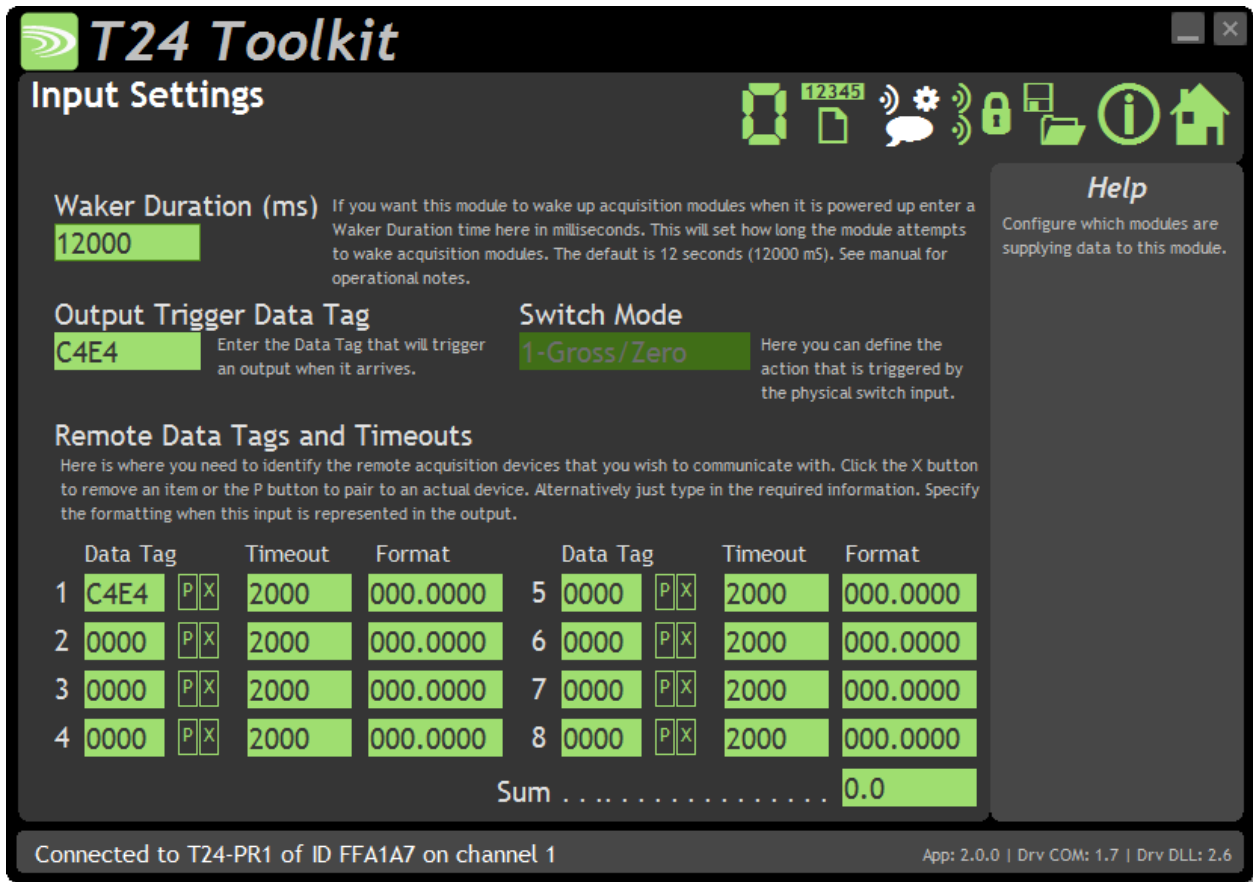

Here you can set the action to take when the switch contacts are closed, set the Data Tag that will trigger an output and also set the Data Tags of the data used as the inputs along with how the data is formatted.

**Items you can change:**

Waker Duration

Entering a waker time in milliseconds will cause this module to wake transmitter modules on the same radio channel and group key when it is turned on.

Switch Mode

**i** *The external button/switch option may be made available on future releases of the T24-PR1*

Click to select either:

**Print** – Triggers an output from the serial port. Note that **Min Interval** setting on the Output Settings page may stop this from working at the rate the contact closes.

**Gross/Zero** – Toggles the measurement mode between gross and net. When switching to net the net value is zeroed (tared). This will affect the value of the <N> token which is the net value of all summed inputs.

Output Trigger Data Tag

Enter the Data Tag which, on arrival, will trigger an output (i.e. print). Note that **Min Interval** setting on the Output Settings page may stop this from working at the rate at which the data arrives.

This is usually set to the Data Tag of one of the inputs.

## Remote data Tags and Timeouts

- Data Tag** Enter the Data Tag (in hexadecimal) to supply data to this input. You can click the 'P' button to retrieve the Data Tag of a module by pairing to it which is usually initiated by power cycling the module. Clicking the X button zeroes the entered Data Tag.
- Timeout** Enter the timeout in milliseconds for this input. If a new Data Provider packet does not arrive within this time and reference to this input value (via token <V1> for example) will result in an output of -----. This also applies to a gross or net reading derived from this input.
- Format** Describe the format that this value is to take when output. You specify integer digits and decimal places by entering a format consisting of zeroes and decimal points. i.e. 00.000



*The integer value of data takes precedent over your defined format so if you defined a format of 0.0 and data of value 100.8265 arrived it would be represented as 100.8*

### Examples

Format	Value	Representation
0.0	1.2	1.2
0.0	100.8	100.8
00.000	6.1234	06.123
00.000	123.4567	123.456
0000.00	12.0	0012.00

### Resolution

It is possible to set the resolution (the smallest unit of change) of the output results by including the numeric value in the format. i.e. 00.005 would only represent the value in steps of 00.005



Log Number	Enter a log number that is used when the <LOG> token is decoded. Each time an output is triggered this log number is incremented. This number will wrap to zero once it reaches the maximum value displayable due to the Log Digits. This parameter is Non Volatile and is stored in internal flash memory each time the <LOG> token is evaluated in a printout. This takes time and reduces the finite life of the flash memory so it is recommended that printouts containing the <LOG> token are not triggered at a rate faster than every 30 seconds.
Log Digits	Set the number of digits to display when the <LOG> token is decoded. Example: If this is set to 2 then the log number will count up to 99 before resetting.
Line Delay Char	This is not alterable and is the character used by the thermal printer to denote the end of a line. You will see the token <0A> in the Output Design page when you press the enter key at the end of a line.
Line Delay	This is not alterable but shows the delay in milliseconds required at the end of each printed line.

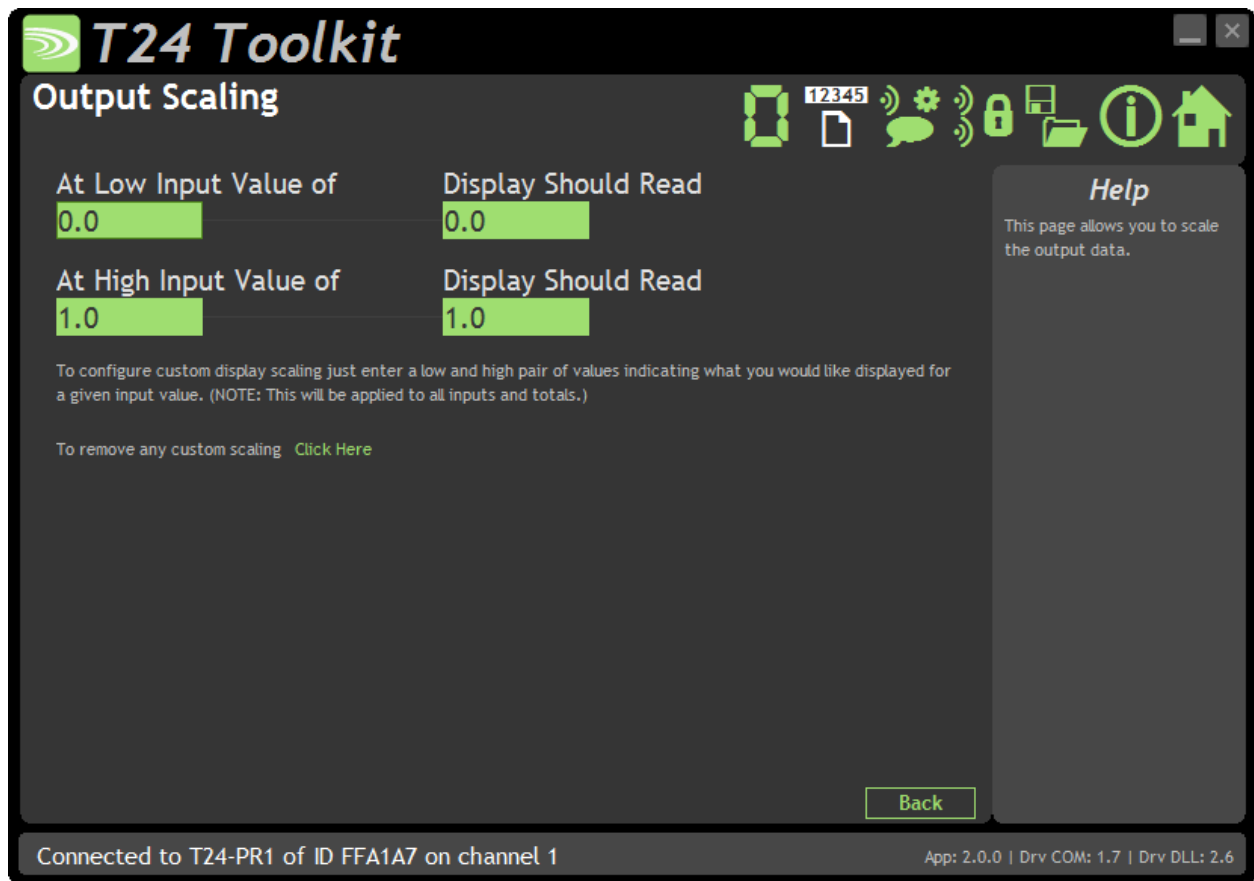

This page allows effective conversion between units. i.e. Although all modules supplying data are configured in kg you can get a printed output in lb.

### Items you can change:

#### Custom Display Scaling

This can be used to change the displayed value to a different unit or to otherwise scale it. You simply enter the original and required values at a low and high point. Example: If a T24-SA was supplying data in kg and you wanted to show tonnes. You would keep both the low points at zero. Enter **At High Input Value** of 1000 and **Display Should Read** Value of 1.

**i** This affects all inputs and sums (both gross and net). All tokens will effectively be decoded using the new scale factor.



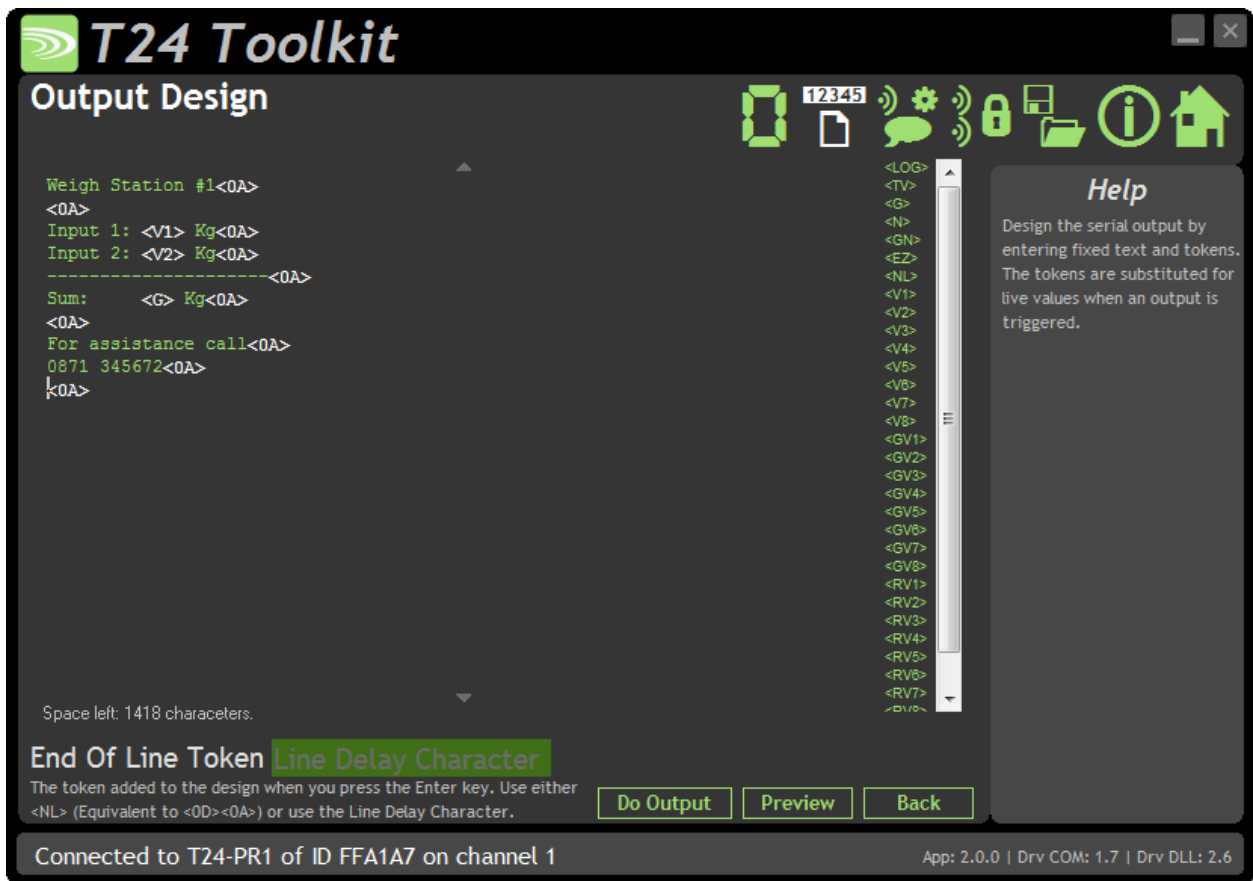

This is where you define the actual printed output based on free text and tokens. Tokens are special codes contained within angled brackets <token> which have special meanings and are converted to actual values once an output is triggered. See list of tokens at the bottom of this section.

**End Of Line Token** This is not alterable. When you press the Enter key on the keyboard we need to know which token to include in the design area. This is fixed to match the End Of Line Character required by the printer hardware.

**Design Area** This is where you create your output using a mixture of free text and tokens. See the example in the screenshot above. To enter a token you can type it in or double click the token list on the right of the page (a single click will display the description of the token).

**i** *By default the printer will print each line readable from the front of the printer. As each line is decoded from your designed lines the effect is that the lines appear on the printout in reverse order. You can compensate for this either by designing your lines in reverse order or including the following tokens at the top of your lines **<1B><63><00>***

**Available Tokens**

Token	Function	Example
<V1> ... <V8>	Substitutes token with the last value received from the input. This will already have system zero subtracted (If a DoSysZero command has been issued.) and tare subtracted. (If a DoTare command has been issued or the switch input has executed a tare.)	1.2345
<GV1> ... <GV8>	Substitutes token with the last value received from the input. This will already have system zero subtracted (If a DoSysZero command has been issued.) but no tare subtracted. i.e. it will always contain the Gross value of the specified input.	1.2345
<RV1> ... <RV8>	Substitutes token with the last value received from the input. This will NOT have system zero or tare values subtracted.	1.2345
<TV>	Substitutes token with the value carried in the Data Provider packet that has triggered the 'Print'. Useful if you use the F1 button on a T24-HA handheld module to trigger a printout as this will contain either the Gross value or the displayed value as configured by the handheld.	1.2345
<LOG>	Substitutes token with the log value. Each time a 'Print' occurs the log number will be incremented.	0003
<G>	Substitutes token with the Gross sum of all active inputs. System zero values will have been extracted.	1.2345
<N>	Substitutes token with the Net sum of all active inputs. System zeros will have been subtracted and also if a Tare has been issued then the tare value will be extracted.	1.2345
<EZ>	Substitutes token with the External System Zero.	1.2345
<GN>	Substitutes token with the GrossText or NetText parameter contents depending on the NetMode.	Gross
<xx>	Substitutes token with the ASCII character whose ASCII value is xx where xx is a two digit hexadecimal value. i.e. <0D>	ÆÖ-ü■

Below are listed some useful hex codes.

Hex Value Token	Description
<0D>	Carriage Return
<0A>	Line Feed
<09>	Tab
<1B>	Escape
<1B> <2D> <01>	Start Underline
<1B> <2D> <00>	End Underline
<1B> <69> <01>	Start Reverse Printing
<1B> <69> <00>	End Reverse Printing
<1B> <57> <02>	Start Large Character Printing
<1B> <57> <01>	End Large Character Printing
<1B> <63> <01>	Print in reverse order (This is the default mode.)
<1B> <63> <00>	Print as designed (Should be placed at the top of the design)

## Example

To print the value from input 1 in reverse:

Current Value: **123.456** kg

Use

Current Value: <1B><69><01><V1><1B><69><00> kg



This page allows you to set a system zero.

**Items you can change:**

Perform System Zero

Clicking this will store the current values on all inputs and subtract the value from all subsequent outputs thus rendering the current input as zero. Example: A 4 input weigh platform will have calibrated transmitter modules but when the actual platform structure is in place each module has a weight value thus the gross value is 50kg. By performing a system zero (with all inputs operational) this is zeroed away so next time the T24-PR1 is powered on the same input will yield a zero result.

Remove System Zero

Clicking this will remove all system zeros and restore all outputs normal.

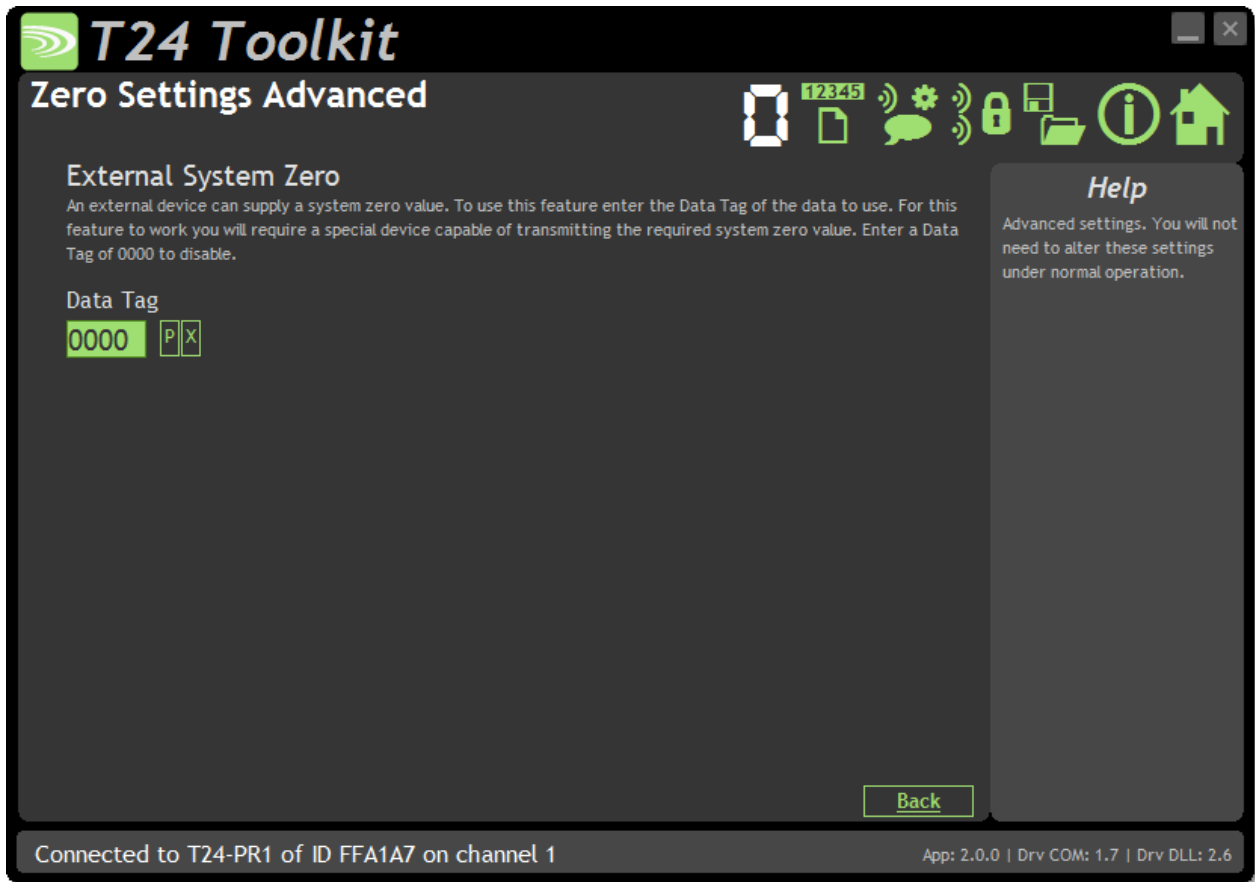

This advanced section allows the use of a specially configured external module to supply the system zero value for the handheld to use.

Example:

The same T24-PR1 is used with a truck that picks up different trailers and is required to display the sum of 4 strain gauges connected to each trailer (Using T24-SAs).

Because each trailer will have a different system zero requirement you would add a further module to each trailer set to transmit the system zero value. It is the Data Tag that is entered here.

On all trailers the transmitter module sets would share the same Data Tags.

**Items you can change:**

Data Tag Enter the **Data Tag** of the message to use for the external system zero.

ID Contains the ID of the module used to supply the external system zero. This is only necessary to provide a visible record of the remote module and is shown to keep compatibility with the **Mode and Communications** page.

You do not need to enter anything here although it will be filled in automatically if you perform a pair to retrieve data.

P Click this to give 5 seconds to perform pairing to automatically provide the Data Tag and ID from a specific module. Usually pairing is activated by removing and replacing the power supply.

X Click this to reset the Data Tag and ID to zero (disabling the external system zero function).

---

## Configuration Examples

---

### Print Gross Sum of 2 Modules to Printer

We need to print the gross sum of 2 modules to a printer with each time the switch input is activated on the T24-PR1.

 *The external button/switch option may be made available on future releases of the T24-PR1*

We need to display the value of each input as well as the gross sum.

We do not want to print more often than once every 30 seconds even if the switch is pressed.

We want the printed output to look like:

```
ABC Electronics Ltd
Weigh Station #1

Input 1: xx.xxxx kg
Input 2: xx.xxxx kg
-----
Sum:   xx.xxxx kg

For assistance call
0871 345672
```

Parameter settings:

```
Line1=<1B><63><00><0A>ABC Electronics Ltd<0A>
Line2=Weigh Station #1<0A>
Line3=<0A>
Line4=Input 1: <V1> kg<0A>
Line5=Input 2: <V2> kg<0A>
Line6=-----<0A>
Line7=Sum:      <G> kg<0A>
Line8=<0A>
Line9=For assistance call<0A>
Line10=0871 345672<0A>
Line11= <0A>
Line12= <0A>
Line13= <0A>
V1Format=00.0000
V2Format=00.0000
SumFormat=00.0000
ValueDataTag1=C675
ValueDataTag2=FF34
PrintTrigger=0000
MinInterval=10000
SwitchMode=0
```

---

## Customer Ticket from Handheld Module

We have a handheld module T24-HA already configured to sum data from 4 modules. We want the F1 button on the handheld to trigger a printout.

We only want to print the gross sum that the handheld passes us. The handheld is configured to send the Gross value as Data Tag **ABCD** when the **F1** button is pressed.

We do not want to print more often than once every 5 seconds even if the handheld tries to do so.

We also want two tickets printed each time it is triggered.

A ticket number (Log Number) will be printed on each ticket and will be incremented after printing each ticket pair.

We want the printed output to look like:

```
ABC Electronics Ltd  
Ticket No: 0007  
Weighment: 12.3456 kg
```

```
ABC Electronics Ltd  
Ticket No: 0007  
Weighment: 12.3456 kg
```

Parameter settings:

```
Line1=<1B><63><00>ABC Electronics Ltd<0A>  
Line2=Ticket No: <LOG><0A>  
Line3=Weighment: <TV> kg<0A>  
Line4=<0A>  
Line5=<0A>  
SumFormat=00.0000  
LogDigits=4  
PrintTrigger=ABCD  
MinInterval=5000  
Duplicate=1 (Yes)
```

---

## Printer Operation and Maintenance

---

### Paper Roll Fitting and Replacement

**1** To open the printer door press the button marked with the arrow in fully.



**2** The door should open slightly. (This may need help opening with a finger nail.)



**3** Now the door can be fully opened.



**4** Once the roll is fitted, close the door ensuring that the paper exits through the small gap at the top of the door and is not skewed.



Note how the paper roll is fitted inside the printer. If the roll is fitted upside down the printer will not print correctly.

---

### Buttons and Indicators

There are two LED indicators that also function as buttons. These are marked SEL (Select) and LF (Linefeed). The red LED marked LF indicates when the printer has power applied. The green LED marked SEL indicates when the printer is online. For the printer to be able to print the printer must be online.



To manually feed the paper the printer must be taken offline. Press the LED/Button marked SEL and the green LED will go out. Now you can press the LED/Button marked LF to feed the paper one line at a time.



Remember to press the SEL button again to put the printer back online to enable it to print again.



## Enclosure & Mounting

View from Top

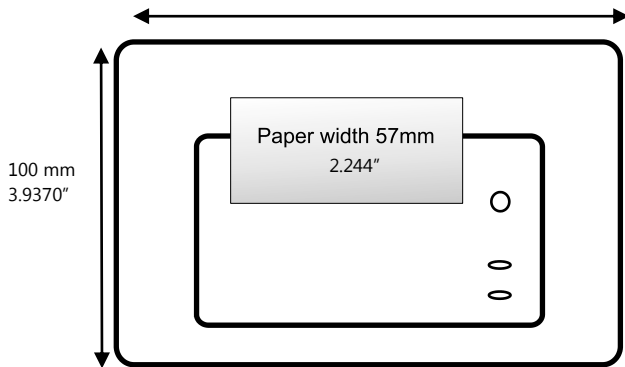

View from Side

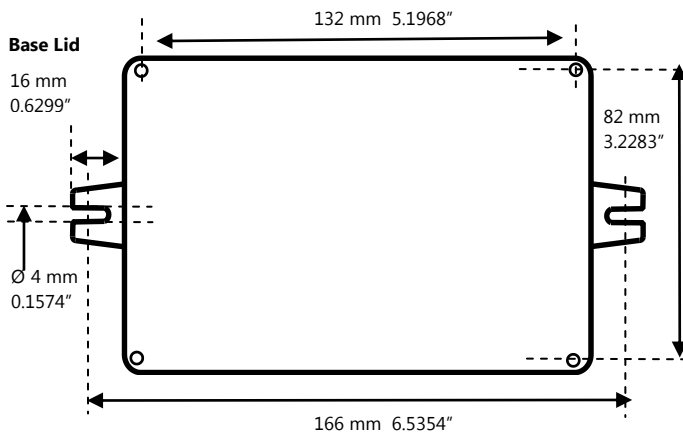
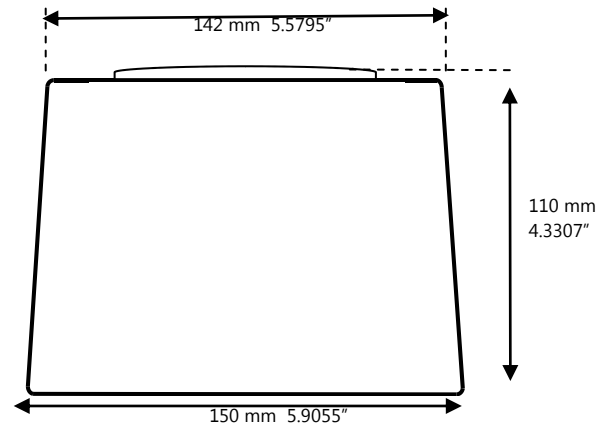

## Antennas

These modules have the antenna already fitted inside the enclosure so there are no specific mounting requirements.

---

## Specification

---

### T24-PR1

Parameter	Minimum	Typical	Maximum	Units	Notes
External Supply voltage Range	9	12	32	Vdc	
Idle Operational Current	6	100	-	mA	
Current when Printing	-	-	3	A	
Operating Temperature Range	5	-	50	°C	
Storage Temperature Range	-20	-	60	°C	
Reverse polarity Protection	-	-	-32	Vdc	Maximum Supply level
IP Rating		IP20			

---

### Printer

Parameter	Specification
Printing Method	Direct thermal line printing
Paper Width	57 mm (2.244")
Paper Diameter	35 mm (1.377")
Print Width	48 mm (1.889")
Resolution	8 dots per mm (384 dots per line)
Print Head Life	6X10 <sup>6</sup> character lines
Print Speed	30 mm/sec (25% utilization)
Character Size	6x8dots , 8x16dots,or12x24dots

---

### Radio Range

To determine radio range please refer to [Appendix B – Antenna Range](#)

### Overview

The T24-RDC collects data from remote T24 transmitter modules and generates CSV files, custom SMS reports and triggered reports that are delivered over the cellular GPRS network and GSM network for SMS messaging. You can either define the active group of remote transmitter modules or allow the module to work automatically, adding new modules as it detects them.

The main logging functionality is to collect data from the remote modules and place the results into a CSV file. You can specify the amount of data stored in the CSV file by setting the age of data it contains. You can also specify at what interval the CSV file is delivered to up to 3 destinations which can be an email address, SMS phone number, FTP server, raw socket or delivered as an HTTP POST to a web server. This allows a very flexible level of control over what data is reported and when. For example, you may want to collect and report only 24 hours worth of data at a time or possibly collect data over one month but still report 1 months worth of data weekly.

SMS reports can be user designed to deliver the data values from specific modules and be triggered by sending an SMS message to the module. Up to 10 SMS reports can be designed. The remote modules can be referenced either by channel number or data tag. These reports are always sent back to the phone that triggered the message.

Up to 20 triggered reports can be user designed that can look for individual modules exceeding limits, reporting errors or local events such as loss of external power and lid open, or even just at set intervals. These alerts can deliver a custom message (that can refer to the channels and values that caused the error) to an email address, SMS phone number, FTP server, raw socket or delivered as an HTTP POST to a web server.



*A single alert can be defined to cover a range or all modules but in this case individual values cannot be reported, just the fact that channels 1,3,4-8 have exceeded set limits etc.*

SMS messaging may also be used to change or update certain user parameters of the module. i.e. You may change a delivery destination of a report or change the interval of reporting. This saves on costly site visits for minor operational changes.

The module has an internal Li-ion battery which can act as battery backup, or in low power mode, may power the module for the required period of operation. An external power supply can increase the operation periods and may be a permanent supply or batteries. The internal battery is recharged by the external power supply.

There are three operational modes: Normal, Low Power and Ultra Low Power. In normal mode incoming SMS messages are processed as they are received and triggered reports are checked in real time. In low power mode the whole module sleeps between captures so cannot act on incoming SMS messages or triggered reports until it next wakes at the log interval. In Ultra Low Power mode the SMS reports and triggered reports are not actioned until the CSV data send interval.

The RDC is a Remote Data Collection module which communicates using GSM/GPRS and therefore is bound by the restrictions and limitations of a mobile data network. This can include but is not limited to partial or complete loss of coverage, environmental interference or network faults.

---

## Order Codes

---

T24-RDC-1, T24-RDC-2, T24-RDC-5, T24-RDC-10, T24-RDC-200



All T24-RDC variants are fitted within a weatherproof enclosure.

---

## Connections

---

### Power



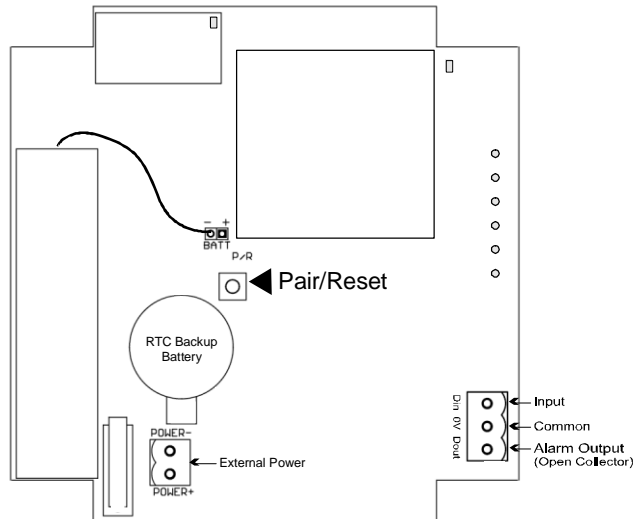



On receipt of the module it may be necessary to connect the battery cable to the connector. Take care that the correct polarity is observed. Usually an external power supply will be required. This is connected to the connector marked 'External Power' and can be from 9 Vdc to 32 Vdc and able to supply 450 mA. Ensure correct polarity is observed.



As soon as power is supplied the module will enter its startup routine.

The above diagram also shows where to connect the digital input and the alarm output. See later in the manual for more information on digital IO.

## LED Indicators

Mode	
T24 Activity	
Network Activity	
T24 Error	
Network Error	
SIM Error	

LEDs indicate:

	During Startup	Awake	Asleep (Low Power Modes)
<b>Mode</b>	Remains off	Flashes 2 X per second	Flashes briefly 1 X per second
<b>T24 Activity</b>	Flashes when T24 data packets are received		
<b>Network Activity</b>	Remains off	Lights when communicating with cellular network	Remains off
<b>T24 Error</b>	Flashes	Lights when no T24 data present for longer than user defined timeout period	Flashes briefly 1 X per second to indicate no T24 data present for longer than user defined period
<b>Network Error</b>	Flashes	Lights to indicate failure to connect to cellular network (flashes fast to indicate a reconnection in progress)	Flashes briefly 1 X per second to indicate last attempt at connecting to cellular network failed
<b>SIM Error</b>	Remains off	Lights to indicate that the SIM is missing, is PIN protected or PUK locked	Flashes briefly 1 X per second to indicate the SIM is missing, is PIN protected or PUK locked

The startup mode can take up to a couple of minutes while cellular network connection is achieved. Startup will commence after the Reset Button is pressed or power is first applied. During startup the **Mode** LED will remain off.

If there is a problem with the on board T24 radio or the cellular network module then either the **T24 Error** LED or the **Network Error** LED will remain lit while the **Mode** LED flashes and the module will be inoperable. Pressing the Pair/Reset switch will reset and try the connections again.

If after applying power or pressing the Reset button the unit detects a problem with the internal real time clock the LEDs will all go out. The unit will reset and try again a few seconds later causing all LEDs to flash on. If this state persists you should remove the battery connector and any external power supply for a few seconds then re-attach.

## Digital Input

The digital input can be used to trigger reports. This requires a volt free contact to activate.

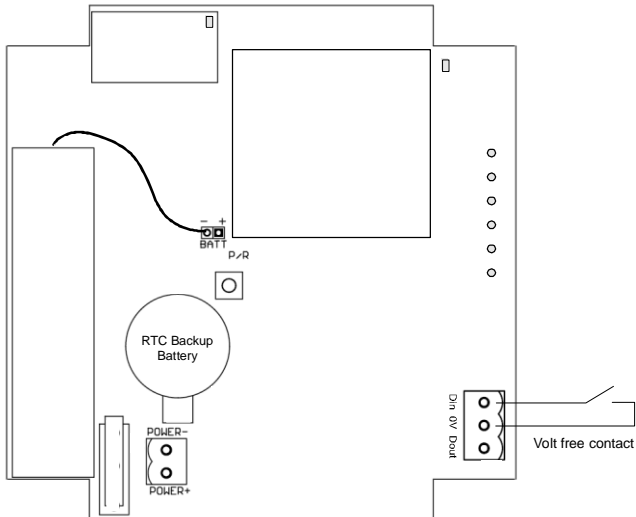

## Alarm Output

The alarm output is triggered when any of the following errors occur:

- SIM error
- Cellular network error
- Cellular network low signal
- T24 timeout
- Lid open
- Realtime clock error
- Watchdog error

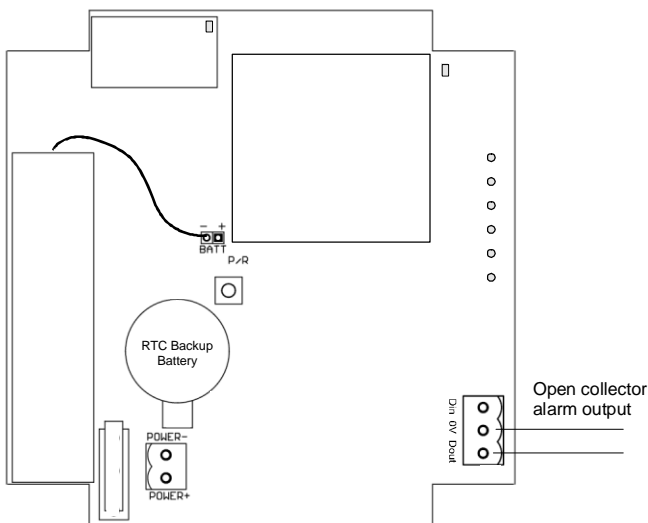

This is an open collector drive and can be used to operate alarms, klaxons etc.

Refer to the specification to see whether you would need relays to drive your required alarm indicator or whether it could be driven directly from the output.

---

## Configuration

The T24 Toolkit provides a means of simple configuration and calibration of the transmitter module along with useful tools to aid integration.

Launch the T24 Toolkit software application and pair to this module to enable the connection to the Toolkit to allow configuration to take place. [See Common Toolkit Pages - Home](#)

---

## System Settings

### General Tab

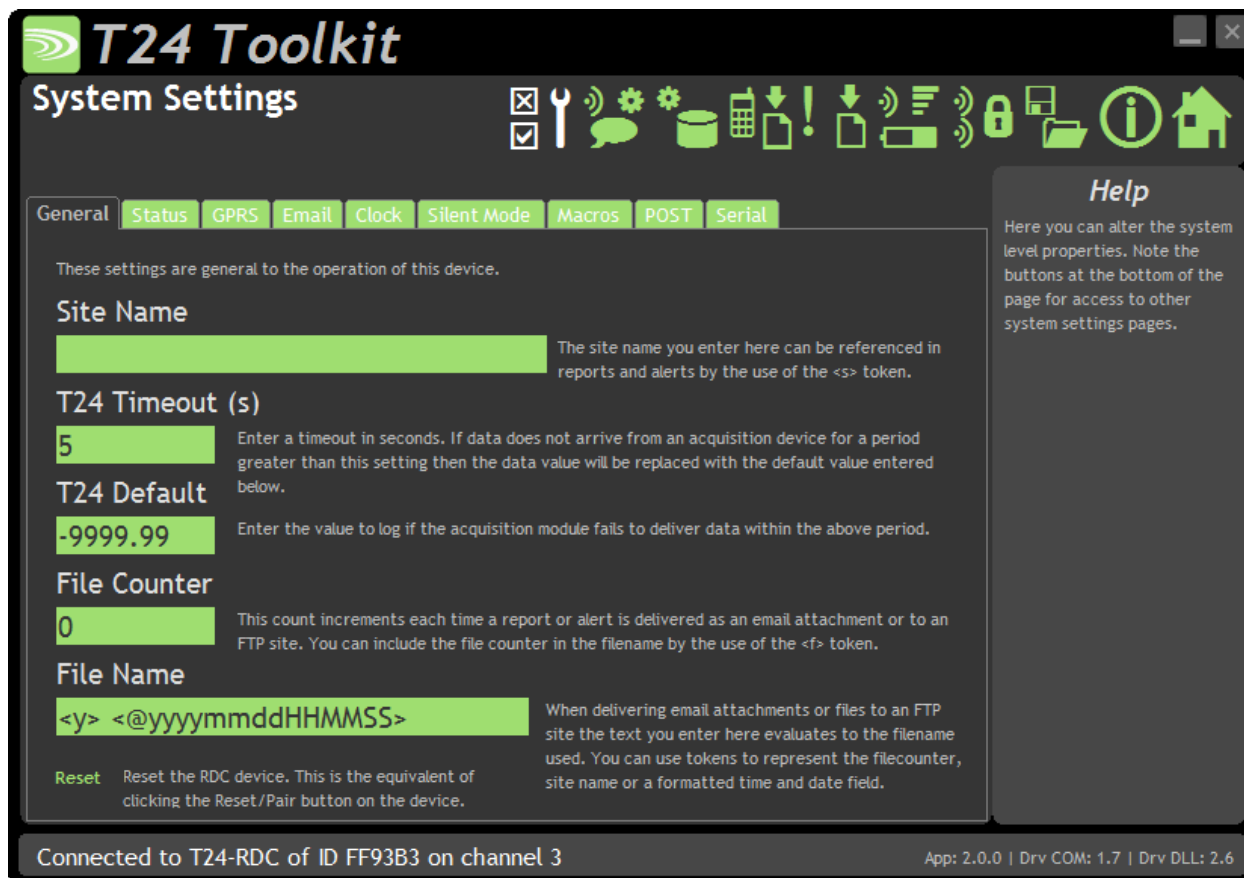

This is where much of the operation settings are configured. The parameters are split over multiple tabs. Just click a tab to move to the desired section.

Changes made on this page are saved automatically.

### Items you can change:

#### General Tab

##### Site Name

This allows a text string to be entered that can be referenced in any other parameter that supports tokens (such as reports or the filename). Use the <s> token for it to be replaced with the text you enter here. See Tokens later in this manual.

##### T24 Timeout

Enter a time here in seconds that if exceeded with no T24 data arriving at all will result in the T24 Error LED to light. Also if individual channels fail to deliver data for longer than this period their value will default to the T24 Default below.



T24 Default	The default value to log when data fails to arrive from a particular channel.
File Counter	Enter a numeric value that is incremented each time a report or CSV data is delivered to an FTP or email destination. This counter can be referenced by any parameter using tokens by using the <f> token.
File Name	You can set the filename text to use whenever a file is delivered to an FTP server (Either reports or the CSV data) or to an email address (CSV data). The filename is common to all but you can make use of tokens to make each file unique. Do not specify an extension. CSV data will be allocated a .CSV extension and reports will be allocated a .TXT extension. Useful tokens include <s>, <y>, <f> and <@xxx> date time formatted tokens.

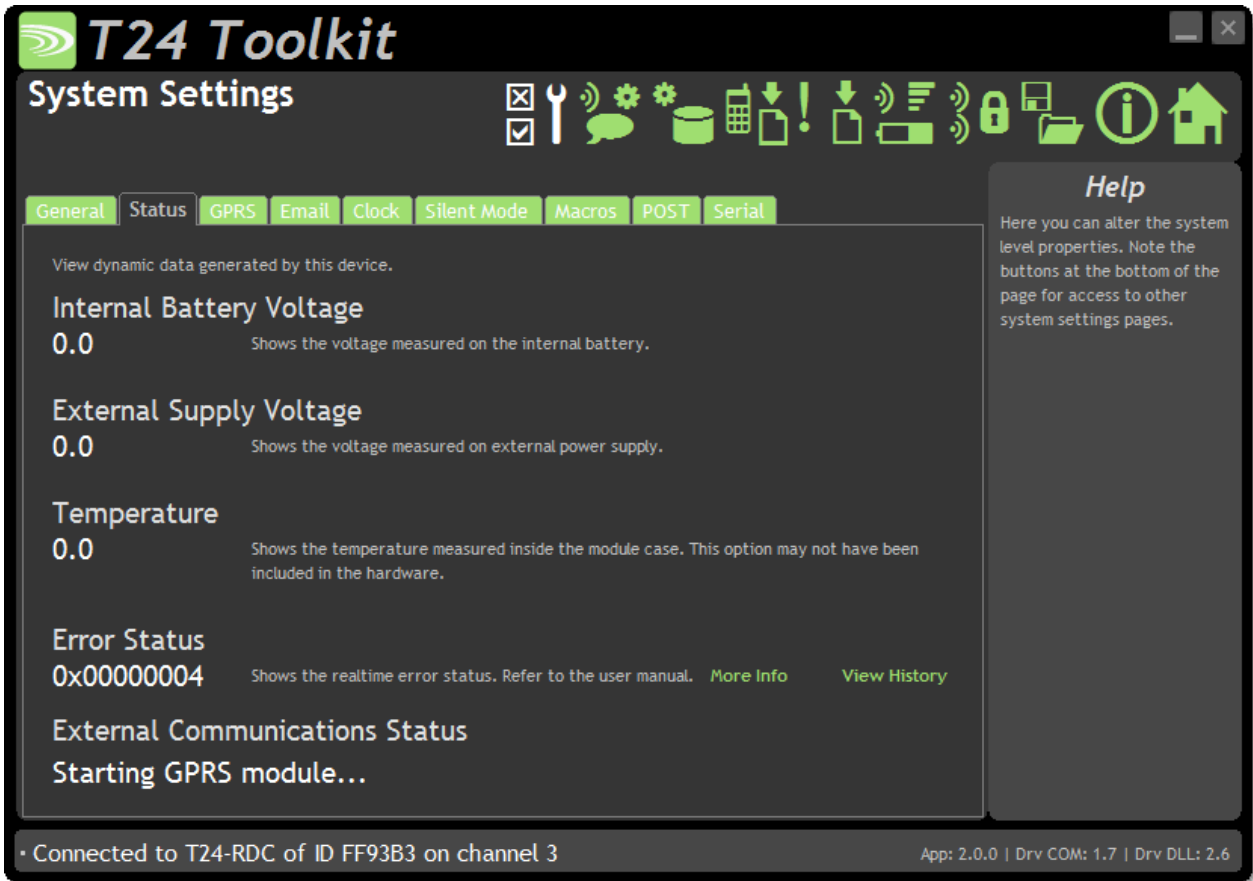

This tab shows some dynamic data which may be of use during diagnostics and installation.

**Items you can view:**

**Status Tab**

Internal Battery Voltage	Shows the voltage measured on the internal battery.
External Supply Voltage	Shows the voltage measured on the external supply.
Temperature	The measured temperature inside the module enclosure.
Error Status	Shows the status of all internal errors. Most errors are non-critical and may appear from time to time such as a failure to deliver a message due to network interruption. Click the more info link to decode the numeric error code into readable errors.
External Communications Status	This indicates the state of the connection to the cellular network. Most of the time this should be idle but will indicate when CSV or report data is being transferred.



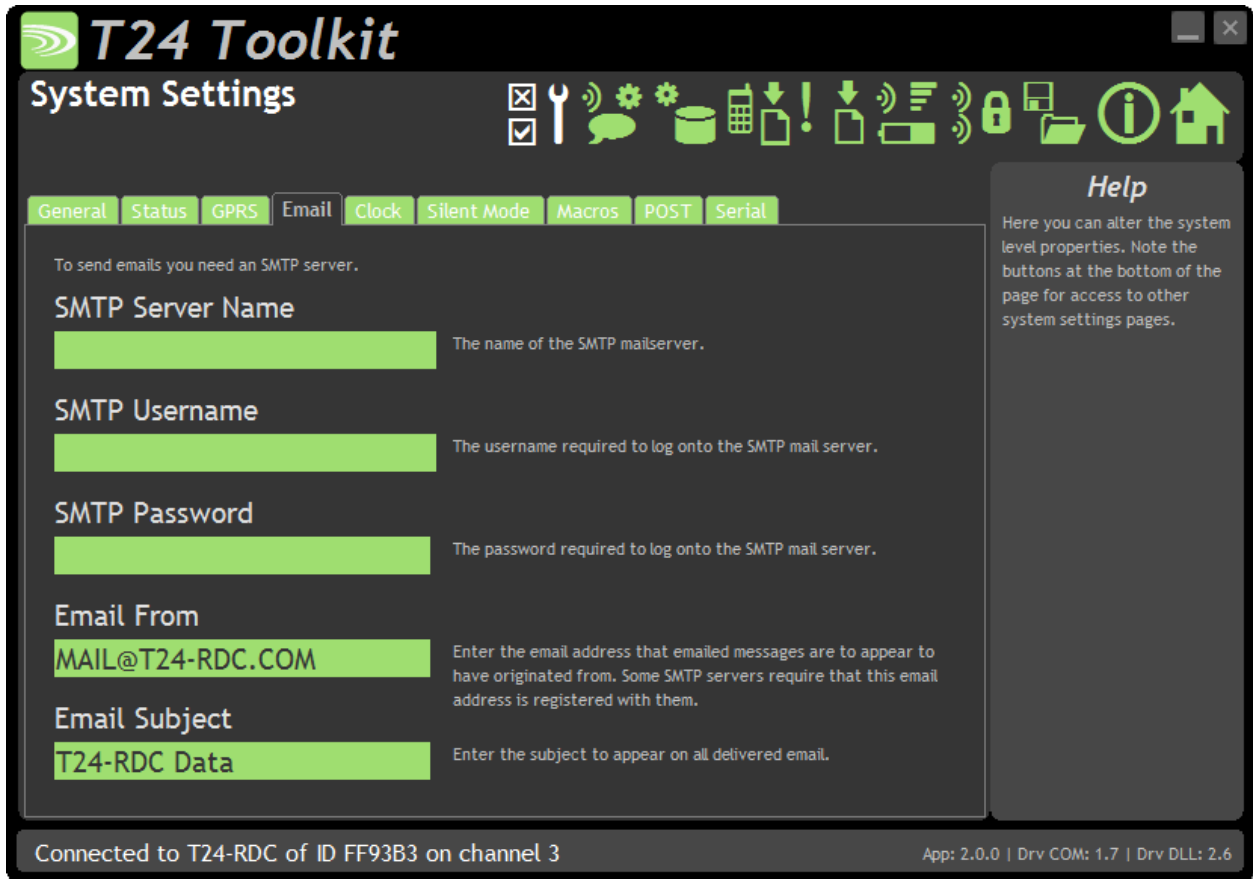

To send email the module requires an SMTP server. You may have a company server through which mail may be relayed or you may use another service provider or possibly the provider of the SIM card.

 The T24-RDC can only connect to an SMTP server on port 25.

**Items you can change:**

**Email Tab**

SMTP Server Name                      Enter the host name of the SMTP server. This may be an IP address or a DNS name.

SMTP Username                          Enter the username required by your SMTP server.

SMTP Password                          Enter the password required by your SMTP server.

Email From                                Enter the email address from which all emails are to appear to have been sent by.

 Some SMTP servers may require a specific email address here to enable using their service.

Email Subject                            Enter a subject to appear in the email subject line. This is common for all delivered email both CSV data and reports so would usually indicate the site from which the module operates.

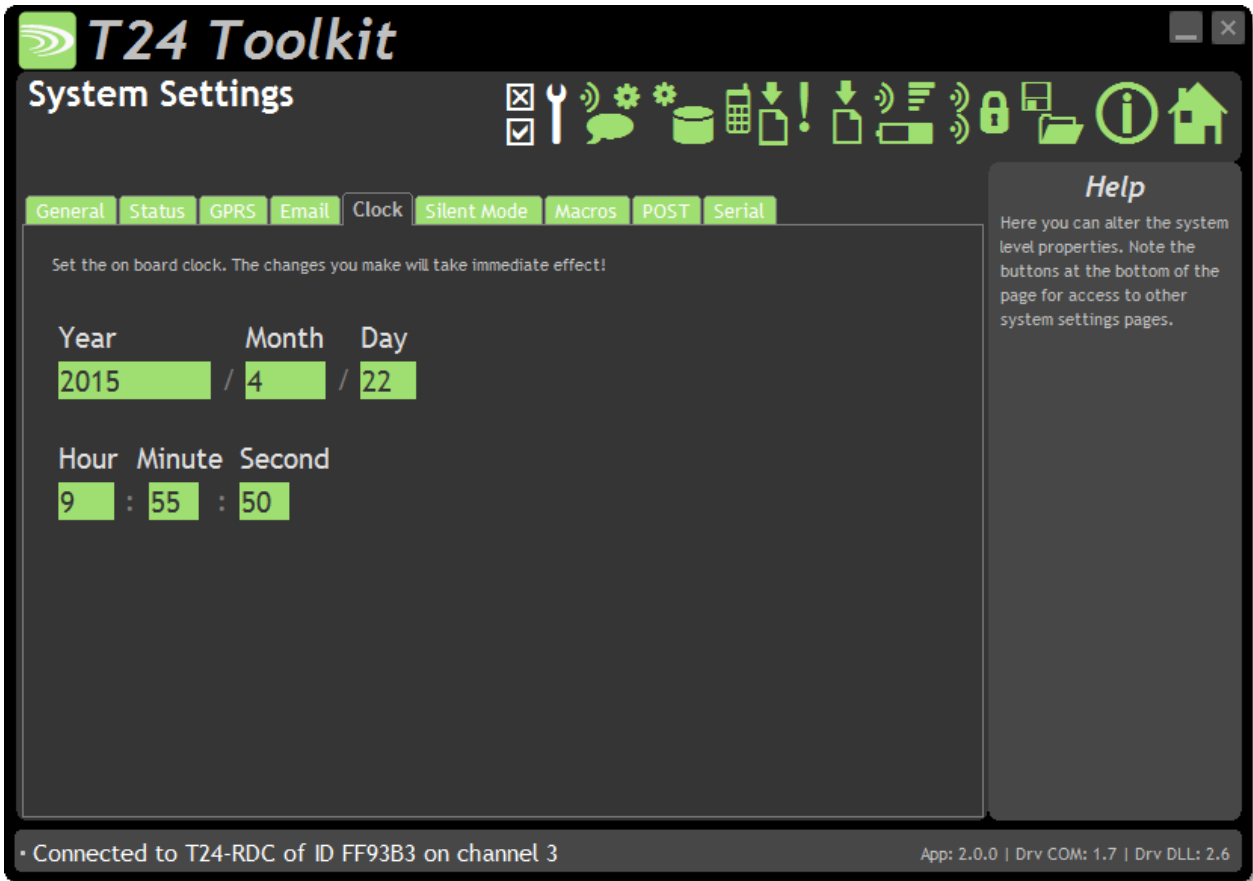

Here you can set the internal real time clock which is used to schedule the data collection and delivery.

**Items you can change:**

**Clock Tab**

- Year** Enter the year using 4 digits.
- Month** Clicking here will open a dialog to allow you to select the month (1-12) on a slider.
- Day** Clicking here will open a dialog to allow you to select the day (1-31) on a slider.
- Hour** Clicking here will open a dialog to allow you to select the hour (0-23) on a slider.
- Minute** Clicking here will open a dialog to allow you to select the minute (0-59) on a slider.
- Second** Clicking here will open a dialog to allow you to select the second (0-59) on a slider.

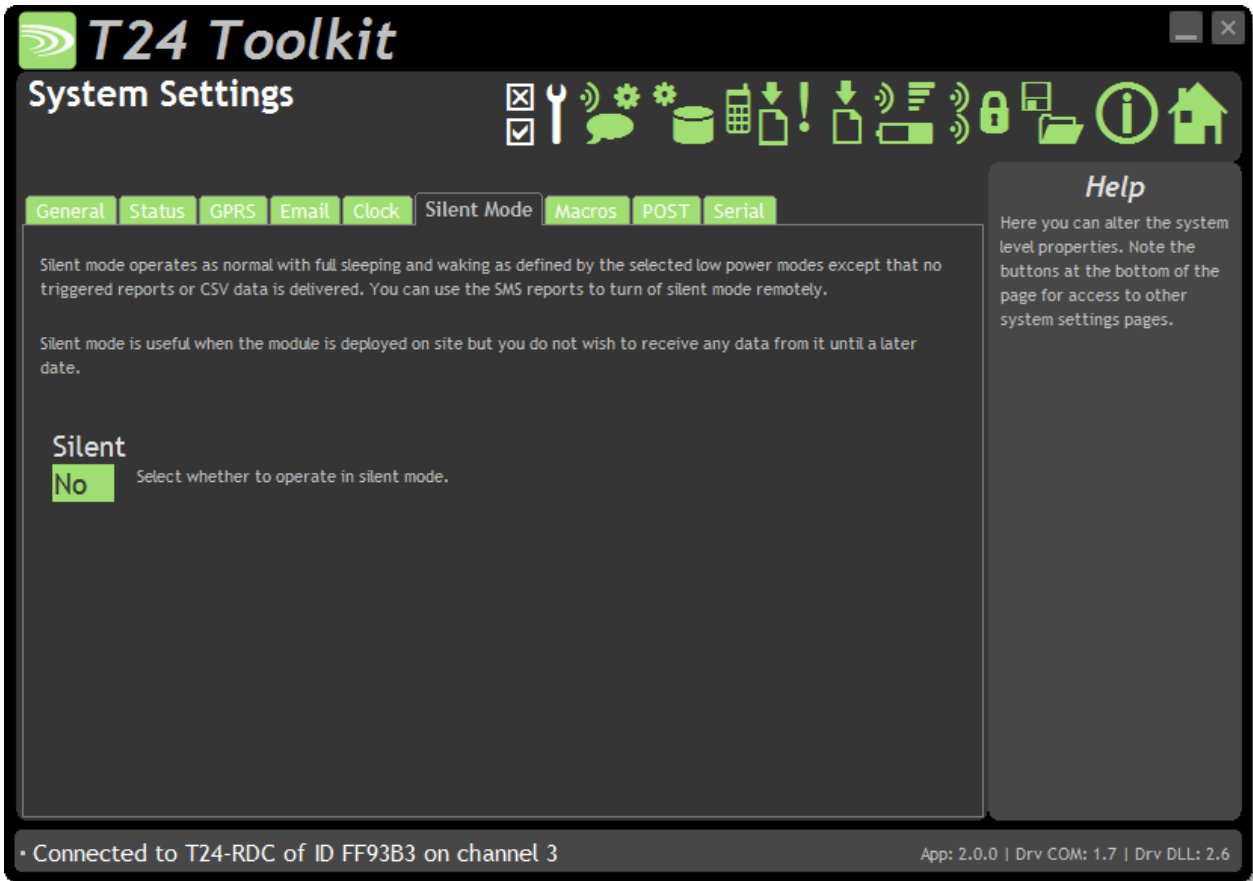

Silent mode can be configured from this tab.

When in Silent Mode the module does not send any reports or CSV data but still operates as normal in all other ways such as low power modes entering sleep etc.

This can be useful if a module is to be deployed on site but no data is required until a later date but having personnel on site to reconfigure is not practical.

By setting Silent to YES the module can be deployed as required and then by using SMS Configuration (See later in the manual) silent mode can be turned off and the data and reports will then be transmitted.

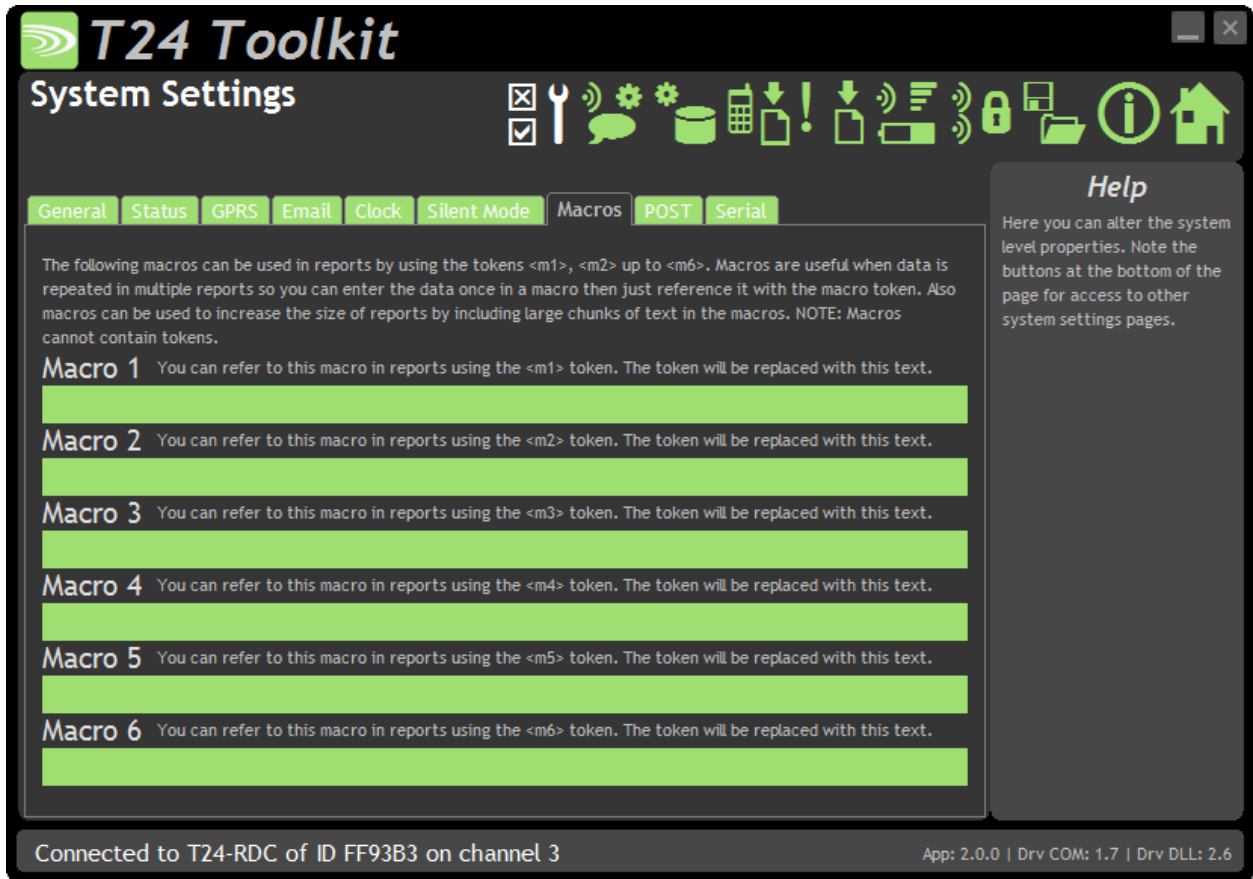

Macros are discrete pieces of text that can be referenced by other parameters that support tokens. This is useful for a number of reasons.

- Reports have a finite size so you could increase the size of the raw report by referencing macros.
- Some information is required in multiple reports. By entering it once in a macro and referencing it in multiple reports it saves on typing.
- Also a macro can be changed by remote SMS configuration (whereas an entire report body cannot) so altering support information delivered in a report could be altered remotely.

**Items you can change:**

**Macro Tab**

Macro 1	Enter the text to substitute for the token <m1>
Macro 2	Enter the text to substitute for the token <m2>
Macro 3	Enter the text to substitute for the token <m3>
Macro 4	Enter the text to substitute for the token <m4>
Macro 5	Enter the text to substitute for the token <m5>
Macro 6	Enter the text to substitute for the token <m6>

 *Macros cannot contain tokens.*

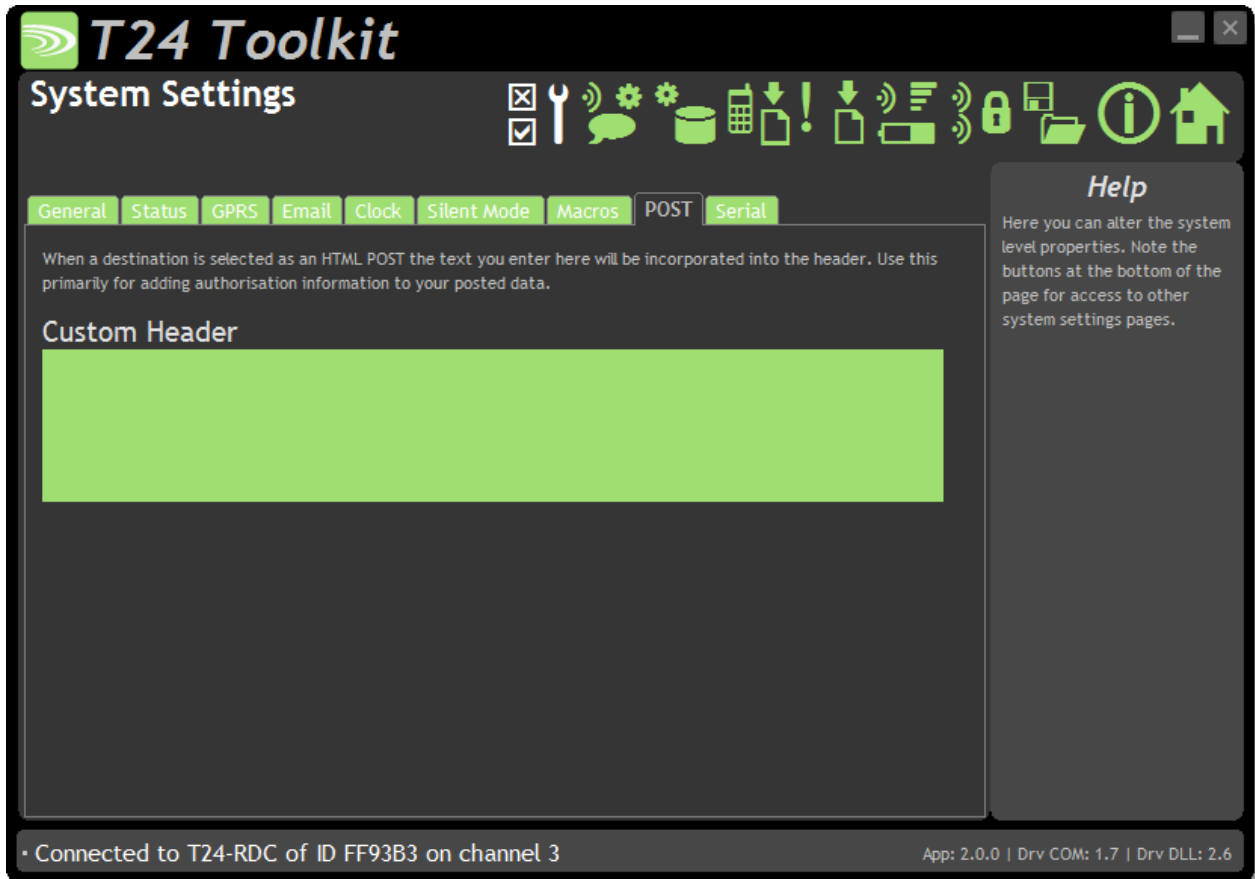

When you post data to a web site or service there may be security in place. Sometimes your data can be authenticated by adding a key to the data content of the post but sometimes the site or service demands a custom header entry to allow you to authenticate.

This may be as simple as:

```
Authentication: AAS56ASD765ASD57ASD5575ADSD
```

Or

```
User: Myname
Password: Mypassword
```

**Items you can change:**

**POST Tab**

Custom Header                      Enter the custom header data here. This will be included in all HTTP headers for destinations defined as POST. See the HTTP Post section later in this manual.





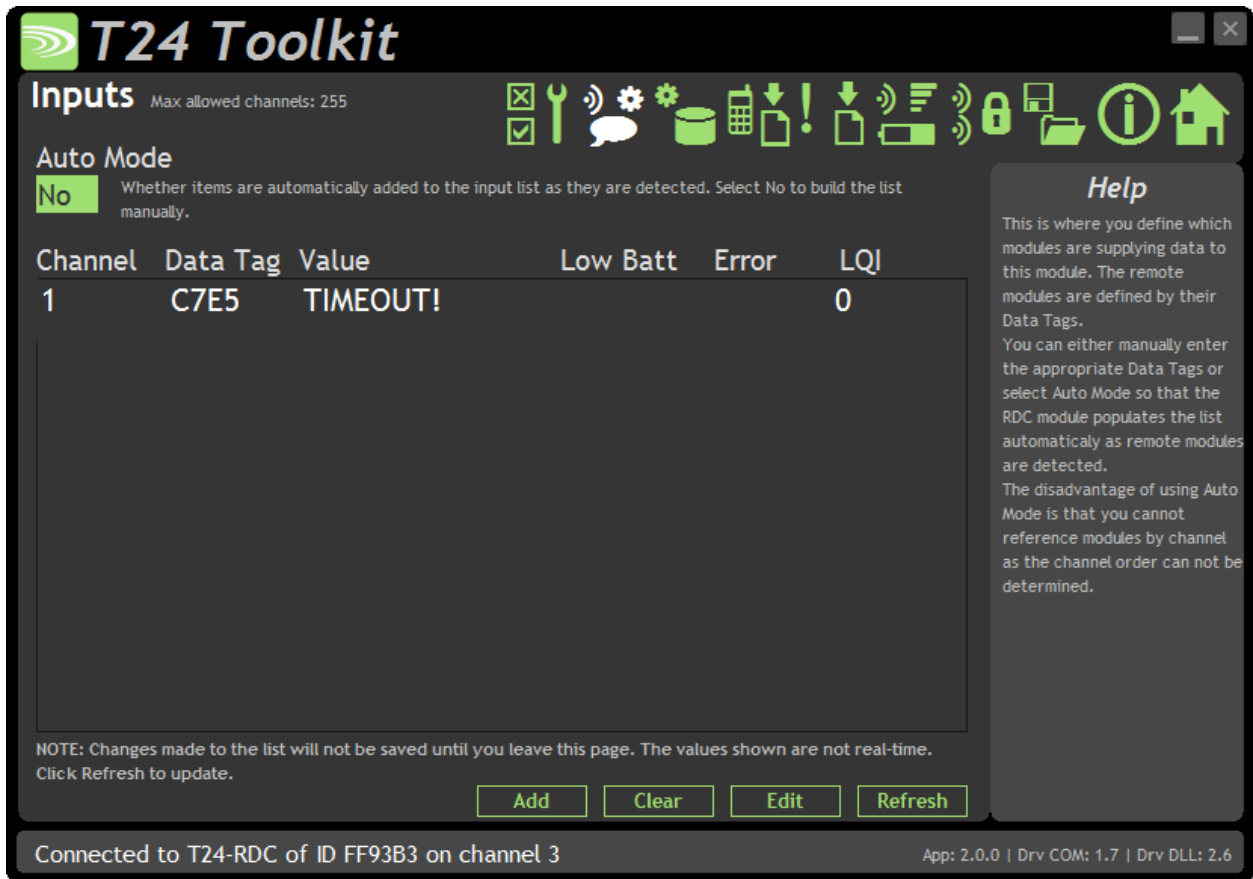

This is where you define which transmitter modules are to be providing data to this module. You can either add the channels manually, by entering the Data Tag of the transmitter modules you want, or by selecting Auto Mode where the list will be populated automatically as data is received. The list will show the last value delivered by each channel or the word **Timeout!** if no data has arrived for longer than the T24 Timeout setting. On RDC versions that support it an LQI (Link Quality Indicator) value will be displayed. This list is not updated in real-time, click the Refresh button to update the list.

The advantage for manually entering the channel list is that you know exactly what each channel refers to and this will not change. This makes it easy to refer to the required channel in reports (<1>, <4> etc.) and you also know what each column represents in the CSV data. In this mode the CSV header will be labelled Ch1, Ch2 etc.

The advantage of using Auto Mode is that transmitter channels can be added at a later date without reconfiguring the T24-RDC module. In this mode the CSV header is labelled with the Data Tag of the channel because the order is not known beforehand. Some disadvantages of this mode are that it makes it difficult to refer to specific channels in reports although reporting of channels which trigger certain report types will be reported correctly. (See Tokens later in the manual) Also note that if the channels are cleared using the Clear button (or deleted using the edit list) then when they are detected again they will be added in a different order than before so any existing data will be in the incorrect columns. If you clear the channels in Auto Mode then it is advisable to also clear the CSV data from the Data Collection page.

**Items you can change:**

Auto Mode	Whether to automatically add channels.
Add Button	Clicking this will allow you to specify a new Data Tag to add.
Clear Button	This clears ALL the currently configured channels.
Edit Button	Changes the display to show a simple list of Data Tags. This allows quick bulk entry of tags from an external source. You can simply paste a list of tags into the list or type them manually.
Refresh Button	Refreshes the list.

---

## Data Collection

This page deals with the creation of the CSV data file. This can be delivered to a variety of destinations but the most useful would be either via email as an attached file or to an FTP server.

---

### CSV File Format

The format of the delivered CSV file is:

```
Time/Date, Temperature, Ch1, Ch2, Ch3.....<CR>
24/08/2010, 21.6, 123.456, 12.567, 99.762.....<CR>
```

In the case of Auto Mode (See Inputs page) the number of fields in the CSV file may increase as new modules are detected. Also the header in Auto Mode will include the Data Tags. In non-auto mode the header line states channel numbers.

---

### Power Mode Tab

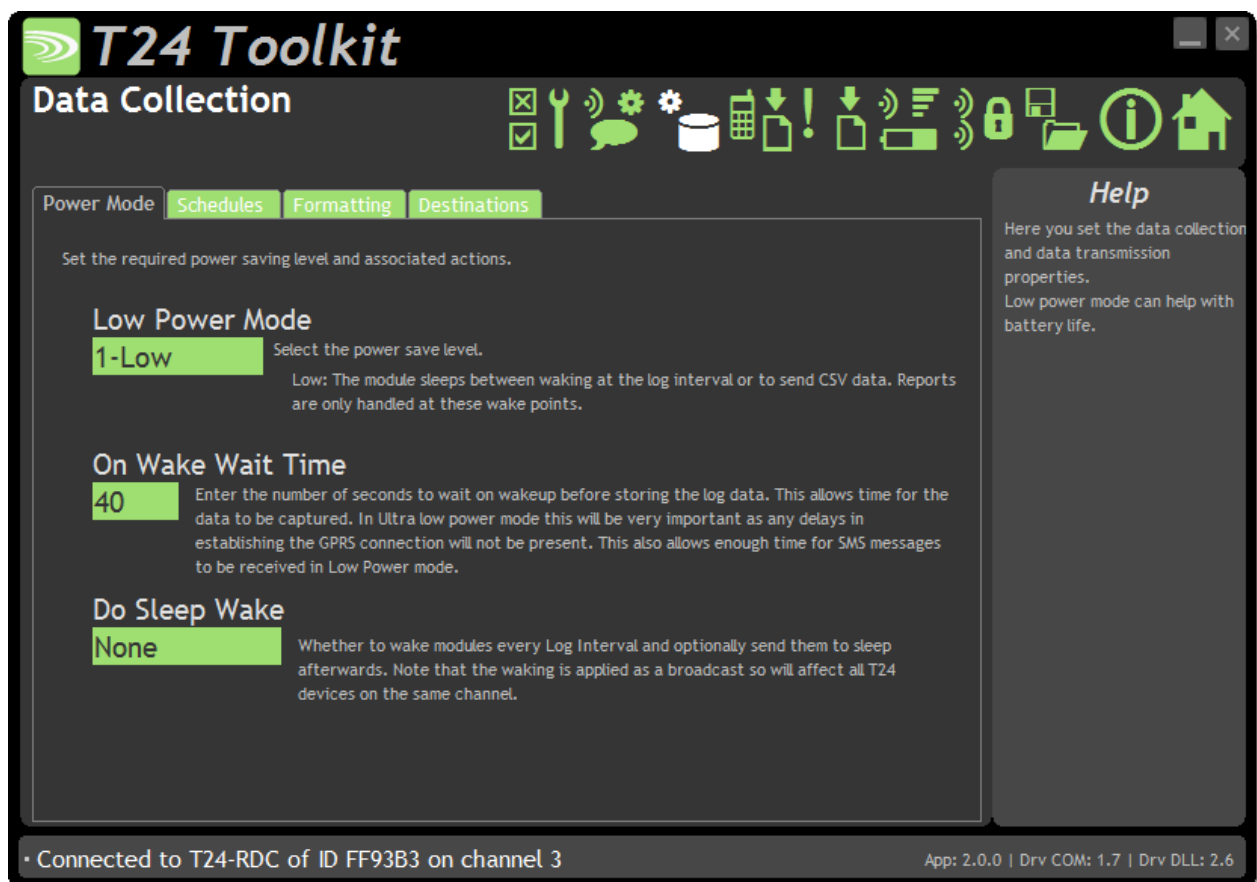

Here you define the how the data is collected and when and also determine how the CSV file is formatted and where it is delivered to. The Power Mode tab lets us change the following.

#### Items you can change:

##### Power Mode Tab

- |                |  |
|----------------|--|
| Low Power Mode | Select the mode to operate in.<br>0 – None<br>The module is permanently awake and can react immediately to SMS Reports and Triggered Reports. This mode would require a permanent external supply. |
| 1 – Low Power  | The module sleeps in a low power mode and wakes at the Log Interval (Set in the Schedules tab) it can then react to SMS Reports and Triggered Reports. This mode                                   |

is for battery powered external power.

## 2 – Ultra Low Power

This achieves the best external battery life of all the modes but the module can only react to SMS Reports and Triggered Reports when the module wakes at the CSV data transmission interval.

### On Wake Wait Time

This determines the minimum time (in seconds) the module remains awake at the log or transmission intervals in Low or Ultra Low Power Mode.

In Ultra Low Power mode this should allow enough time for the module to capture the data supplied by the transmitter modules so may be in the order of 5 to 10 seconds.

In Low Power Mode this may be increased to allow the module to process incoming SMS triggers for SMS reports. On connecting to the cellular network it may take up to 40 seconds or more for the network to send the module any stored SMS messages. This should always be less than the Log Interval time.

### Do Sleep Wake

Only used in Low Power Mode.

Determines whether the module will wake transmitter modules when it wakes up itself.

You can also select whether the RDC sends the modules back to sleep after a reading has been recorded.



*It is advisable to also set a Sleep Delay on the transmitter modules and not rely solely on the RDC to send the modules to sleep.*

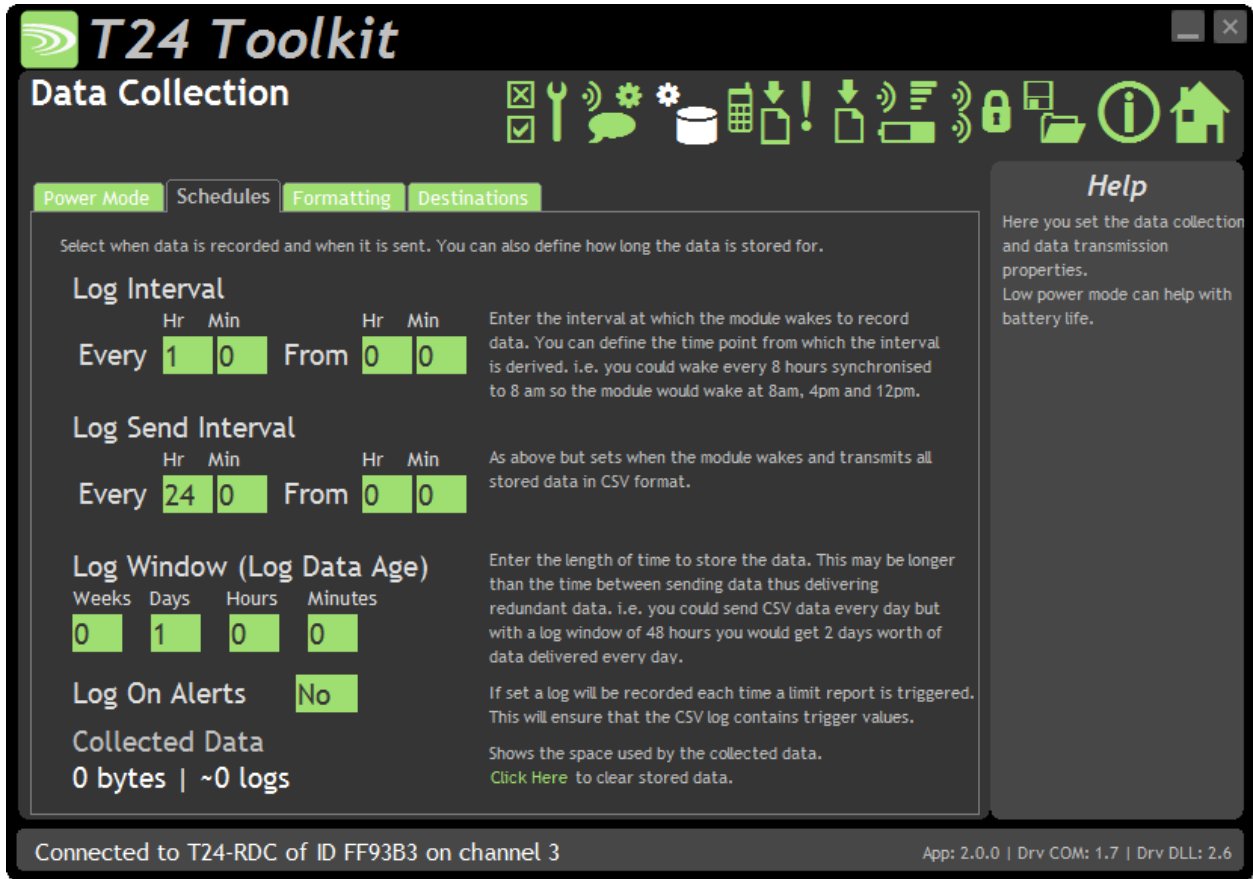

This tab sets the intervals at which data is collected and at which the CSV data is transmitted. This has an effect on battery life as in Low and Ultra Low Power modes the Log Interval determines how often the module wakes from a very low power sleep mode. See Battery Life section

**Items you can change:**

**Schedules Tab**

- Log Interval

This is the interval that the values from the transmitter modules are recorded as a new row in the CSV data.
- Every Hr Min

Specify the hours and minutes between the logs. Although this allows a minimum of 1 minute intervals that will not be achievable in any of the low power modes as it takes time to wake and connect to the GPRS network.
- From Hr Min

The above interval is not just arbitrarily calculated from the time the module is switched on but is synchronised to real time. Here you can specify the time from midnight to synchronise the interval from. i.e. you can set an interval of 8Hr 0Min synchronised to 8Hr 0Min so the logs will take place at 8am, 4pm and 12pm.
- Log Send Interval

This is the interval that the CSV data is transmitted to the specified destinations.

Every Hr Min	Specify the hours and minutes between the transmissions. This is not recommended to be less than around 5 minutes. Also note that the size of the CSV data that is sent, the number of destinations and other reports may take more time than the interval specified here. i.e. there may be a minimum log send interval that you can use depending on other settings. The RDC has not been designed for high speed transmission of data.
From Hr Min	The above interval is not just arbitrarily calculated from the time the module is switched on but is synchronised to real time. Here you can specify the time from midnight to synchronise the interval from. i.e. you can set an interval of 6Hr 0Min synchronised to 6Hr 0Min so the logs will take place at 6am, 12am, 6pm and 12pm.
Log Window	Here you can specify how much data the CSV file contains. As new data is added at the log interval any data older than the age set here will be deleted. By adjusting this time you can dramatically alter the delivered data. i.e. with a CSV data delivery daily you could use a window of 1 day so that each delivery contains all logged data since the last delivery. By doubling the window you could deliver 2 days' worth of data daily. This would protect against one delivery failing due to network unavailability for example. By setting the window to zero or less than the log interval you would deliver one line containing just the last data gathered from the transmitter modules.
Log On Alerts	If this option is chosen then a log will take place every time a triggered report based on the value from an input module is triggered. (i.e. greater or less than a user defined limit). This ensures that the CSV data contains the value that caused the report to trigger.



The user of the CSV file must use the date/time stamp to determine when the data was logged and not just assume it was logged at the Log Interval!

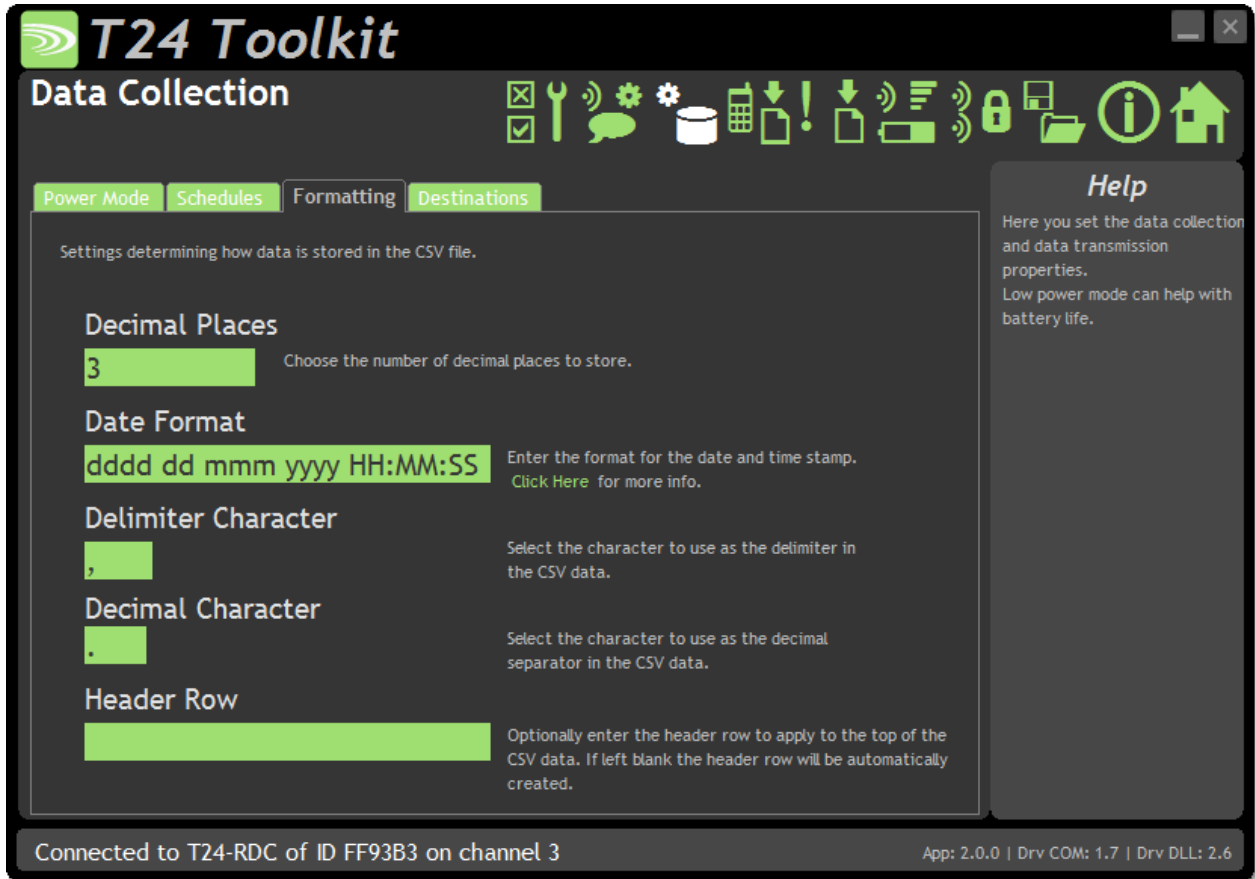

Here you can specify how the data is formatted in the delivered CSV file.

**Items you can change:**

**Formatting Tab**

**Decimal Places** Select the number of decimal places to show in the recorded data. This is global for all channels.

**Date Format** Specify the format of the date and time field of the data. The formatting characters are converted to actual time and date when the data is recorded to the CSV file.

You format the way the date and time stamp is represented by using the following groups of case sensitive characters:

Element	Description
"yy"	The last two digits of the year (that is, 2009 would be displayed as "09").
"yyyy"	The full year (that is, 2009 would be displayed as "2009").
"mm"	The two-digit month number. Single-digit values are preceded by a zero.
"mmm"	The three-character month abbreviation.
"mmmm"	The full month name.
"dd"	The two-digit day. Single-digit day values are preceded by a zero.
"ddd"	The three-character weekday abbreviation.
"dddd"	The full weekday name.
"hh"	The two-digit hour in 12-hour format. Single-digit values are preceded by a zero.



"HH"	The two-digit hour in 24-hour format. Single-digit values are preceded by a zero.
"MM"	The two-digit minute. Single-digit values are preceded by a zero.
"SS"	The two-digit second. Single-digit values are preceded by a zero.
"TT"	The two-letter AM/PM abbreviation (that is, AM is displayed as "AM").
"ee"	The full time and date encoded numerically in the MS Excel format.
"EE"	Epoch format in milliseconds elapsed since 01/01/1970.

Any other characters will form part of the formatted output.

i.e.

**'mmmm dd yyyy at HH:MM:SS'**

would decode to

**'January 15 2009 at 12:23:05'**

Delimiter Character	Specify the character used between the values. Usually the UK setting would be a comma but some countries use a semi-colon.
Decimal Character	Specify the decimal separator. Usually in the UK this would be a decimal point but Europe would use a comma.
Header Row	You can override the automatic header row at the top of the CSV file by entering a custom one here. i.e. <b>Date , IntTemp , Strut1 , Strut2 , ExtTemp</b>

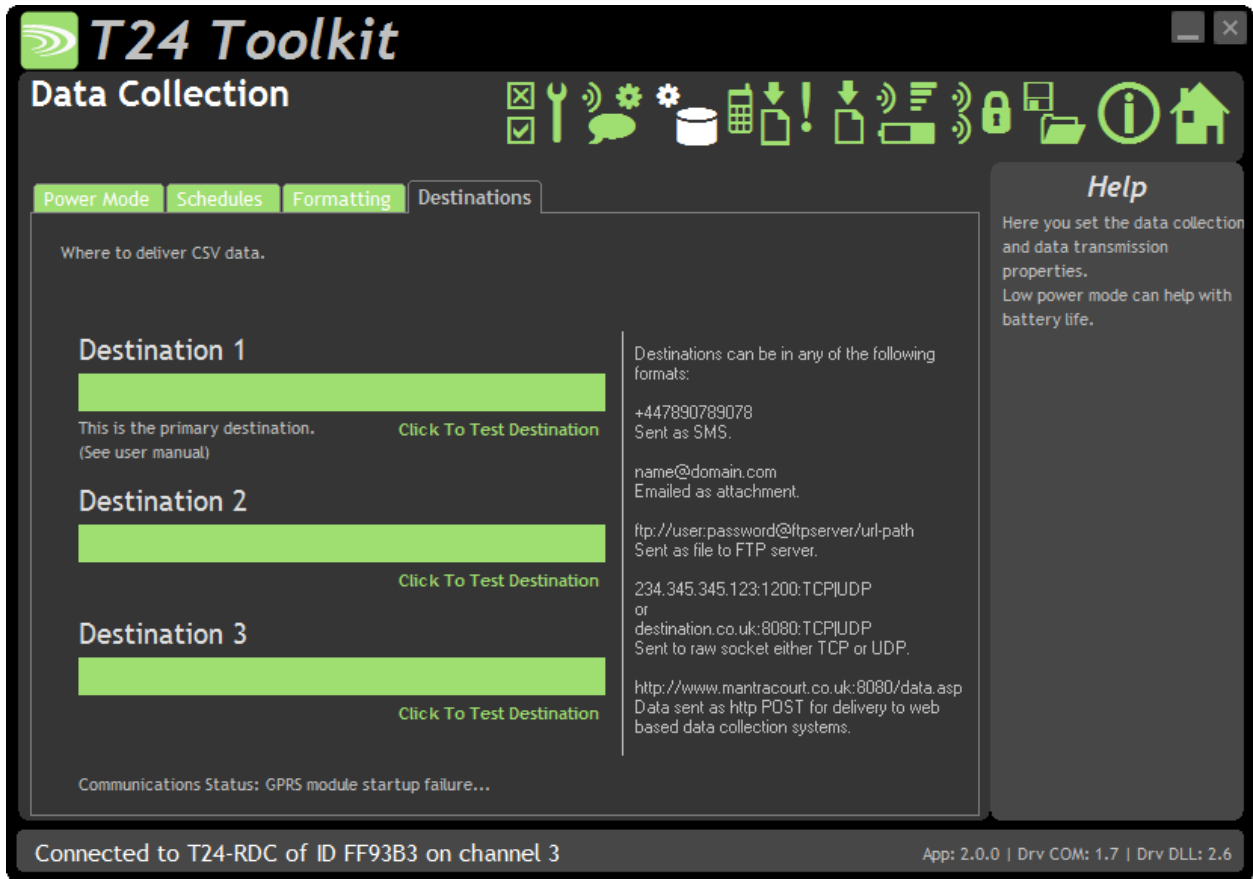

Here you specify up to three destinations for the delivered CSV file. All three destinations are attempted and you can leave any one blank if not required.

Destinations must be formatted as follows.

Type	Format
Email	mailbox@yourcompany.com
FTP	ftp://user:password@ftp.yourcompany.com/path
HTTP POST	http://webdata.domain.com/adddata.asp:8080
TCP	123.123.0.1:1002
SMS	+44678968672

**i** *If HTTP POST is selected as a destination the contents of the CSV file will be the POST data. i.e. the module does not perform an HTTP File Upload.*

See the Destinations section later in the manual.

Clicking the 'Click To Test Destination' link under each destination will cause the word TEST to be sent to the specified destination. See the lower part of the page for the status and result of this test. You will also need to check the actual destination for the delivered message to ensure that you have entered the correct details.

**Items you can change:**

**Destinations Tab**

- |               |   |
|---------------|---|
| Destination 1 | Enter the required destination. NOTE that this is the primary destination and if in Low Power mode and this delivery fails it will be retried at every subsequent Log Interval. |
| Destination 2 | Enter the required destination.   |
| Destination 3 | Enter the required destination.   |

## SMS Reports

These reports are triggered by sending the module an SMS message. On receipt of the correct password the module will reply with the user defined report text to the sending phone.

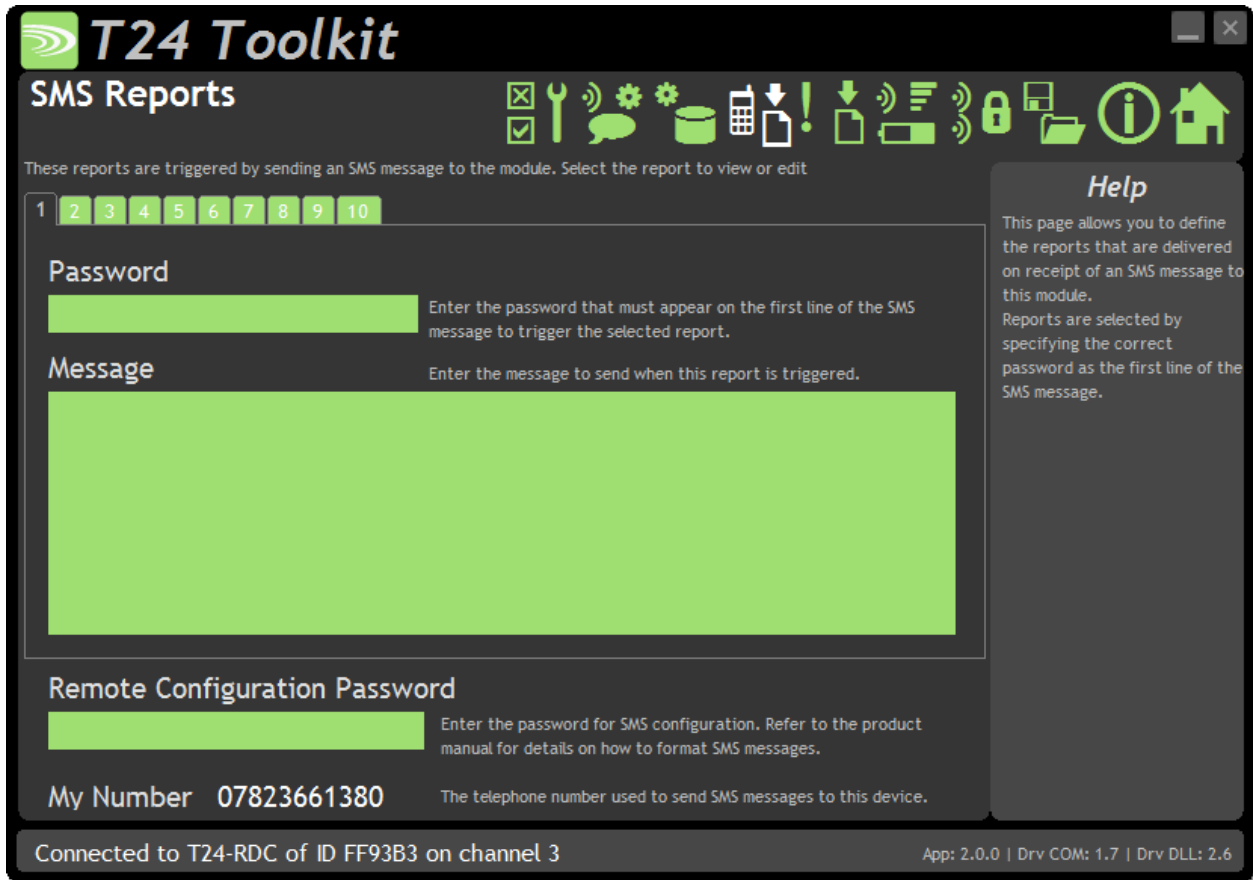

The ten reports can be accessed by clicking the appropriate numbered tab at the top of the page. NOTE that the changes are not saved until you click to another page.

### Items you can change:

- Password** Enter the case insensitive password that must be on the first line of the SMS message to trigger this report response.
- Message** Compose the response message here. This message can contain tokens that are decoded at the time of message generation and can contain real time values such as battery voltage or channel values. See Tokens section later in manual.

**i** if the message is just a question mark (?) then the contents of the triggering SMS message (after the password line) are used to create the response message. Therefore you can create the desired message, including tokens, remotely to receive any custom information required.

## Remote Configuration Password

Here you can set a password that if received as the first line of an SMS message, will take the rest of the SMS message as a configuration script.

This allows you to change some parameters remotely via SMS. Just blank the password to disable this feature.

To use this feature you would send a message to the module with the password (case insensitive) on the first line followed by a set of **parameter=value** instructions.

Each line is evaluated and the specified value is applied to the parameter. If an error occurs processing of further instruction lines is halted.

You will get a response SMS message showing which instructions were set OK and where failures (if any) occurred.

### Example SMS

```
ConfigPassword
sn=My New Name
SILENT=0
cd1=+44897987978
```

### Example Response

```
sn=My New Name OK
SILENT=0 OK
cd1=+44897987978 OK
```

If there is a problem setting the value you may see one of the following errors:

Error	Description
NAK	The data was rejected by the T24-RDC as Not Acknowledged
Invalid Data	The data itself was rejected by the module
Unknown	The parameter that was stated was unknown/unrecognised
Error	An unforeseen error has occurred

**i** Some phones make adding a carriage return difficult. You can use the pipe character as an alternative to a line break (The pipe character is the vertical bar '|'). So for the above example you could send:

```
ConfigPassword|sn=My New Name|SILENT=0|cd1=+44897987978
```

See the next section for a list of valid property names for use in the SMS messages.

**i** Depending on the low power mode selected you may not see an SMS response until the next log interval or in the case of ultra low power mode until the next transmission of the CSV data.

## SMS Configuration

The following parameters are available to change via SMS. They are case insensitive but should not have spaces between the short name and the equals sign nor between the equals sign and the value.

Name	Description	Example
SILENT	Turn on or off silent mode. Set 1 to turn on silent mode and zero to turn off silent mode	silent=0
YR	Set the year of the real-time clock. Use the fill 4 digit year representation	yr=2010
MO	Set the month of the real-time clock	mo=12
DY	Set the day of the real-time clock	dy=31
HR	Set the hour of the real-time clock	hr=24
MN	Set the minute of the real-time clock	mn=59
SD	Set the second of the real-time clock	sd=59
FC	Set the file counter value	fc=0
FN	Set the filename template	fn=<y> <f> <@dd-mm-yy HH-MM>
LI	Set the log interval. This must be entered in minutes	li=300
CI	Set the CSV send interval. This must be entered in minutes	ci=1440
CW	Set the CSV logged data window. (The amount of data to store). This is entered in minutes	cw=5760
CD1	Set the CSV data file destination 1	cd1=+44789123456
CD2	Set the CSV data file destination 2	cd2=info@mydomain.com
CD3	Set the CSV data file destination 3	cd3=ftp://user:pass@domain.com/folder
SI	Set the SMTP server IP address or name	si=123.075.035.127
SU	Set the SMTP server username	su=myname
SP	Set the SMTP server password	sp=mypass
ES	Set the email subject line	es=Remote Data
EF	Set where the email would appear to be sent from (Note that some SMTP servers require that this be a particular registered email address)	ef=remote@mantra.com
WW	Set the wakeup wait interval in seconds	ww=60
TT	Set the T24 timeout in seconds	tt=5
TD	Set the T24 default value	td=-1999.99
RI	Set the report item to which the following commands will refer	ri=1
RF	Set the channel range 'From' for the selected report	rf=1
RT	Set the channel range 'To' for the selected report	rt=3
RV	Set the trigger value for the selected report	rv=100.0
RM	Set the minimum interval in minutes for the selected report	rm=30
RD1	Set the destination 1 for the selected report	rd1=+447891234567
RD2	Set the destination 2 for the selected report	rd2=info@mydomain.com
RD3	Set the destination 3 for the selected report	rd3=ftp://user:pass@domain.com/folder
M1	Set the text for macro 1 (Remember that the macros cannot contain tokens)	m1=contact Matt on 07891234567
M2	Set the text for macro 2	m2=upper support
M3	Set the text for macro 3	m3=West Mount Site
M4	Set the text for macro 4	m4=Channel
M5	Set the text for macro 5	m5=kg
M6	Set the text for macro 6	m6=-----

## Triggered Reports

### Trigger Tab

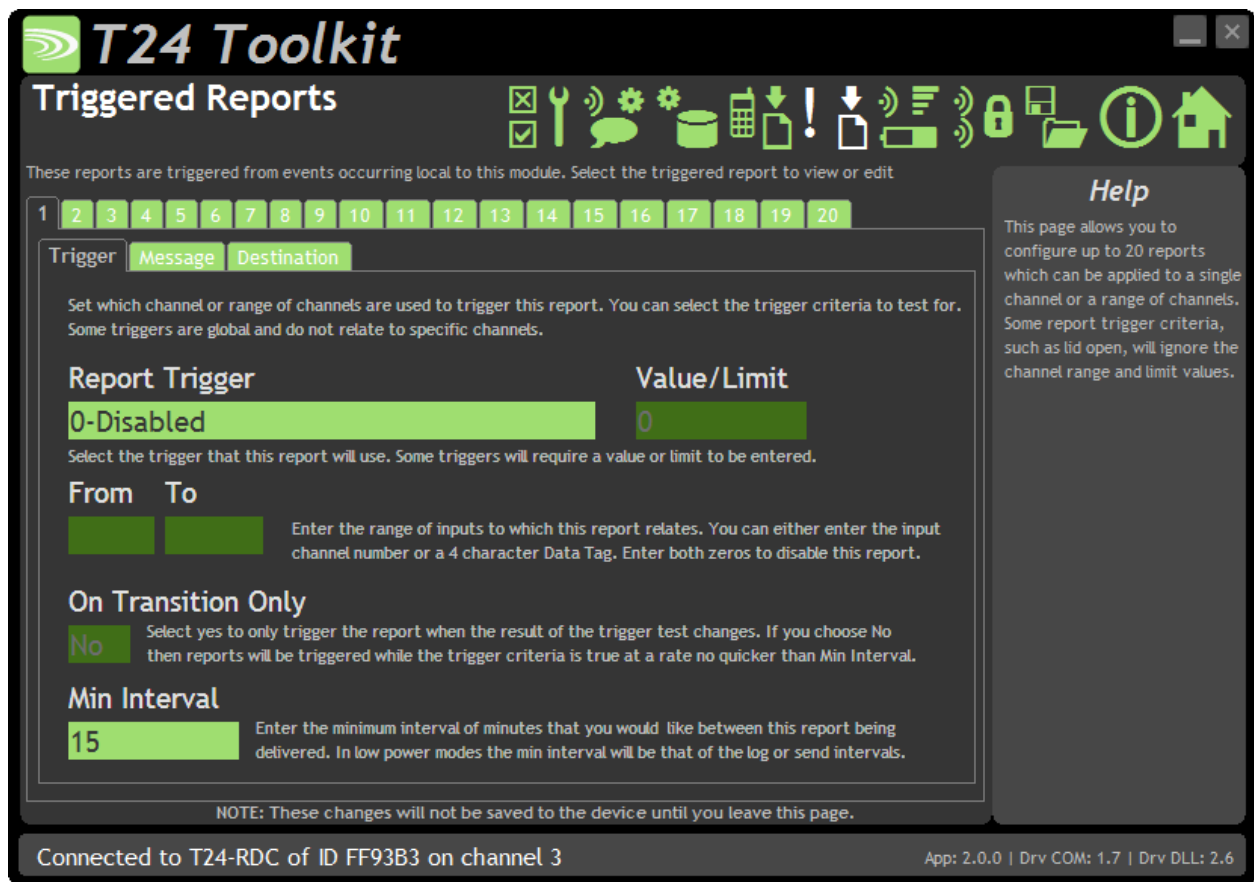

There are 20 reports that can be pre-defined and triggered by local events or at set intervals. These can deliver alert/alarm type information or just deliver data to data collection systems etc.

Click on one of the numbered tabs to select a particular report to edit.

NOTE that the changes made while on this page are not saved until you select a different page (not just a different numbered tab).

#### Items you can change:

Report Trigger

Here you can select the type of trigger for sending the report. Certain triggers may cause other fields on this page to be disabled.

Selection	Description
0-Disabled	This report is disabled
1-Greater Than Limit	Check the specified channel range against the specified value and trigger the report if the channel value exceeds this value
2-Less Than Limit	Check the specified channel range against the specified value and trigger the report if the channel value is less than this value
3-Remote Integrity Error	Check the specified channels and trigger the report if any report an integrity error (A problem with their input)
4-Remote Low Battery	Check the specified channels and trigger the report if any report a low battery

5-Remote Error	Check the specified channels and trigger the report if any report an error or communications is lost. This will include battery low errors and may indicate other internal errors. Refer to the transmitter module manual section for details.
6-Sum Greater Than	Check the sum of values from the specified channel range and trigger the report if the summed value exceeds the specified value
7-Sum Less Than	Check the sum of values from the specified channel range and trigger the report if the summed value exceeds the specified value
8-Change Increasing	Not yet implemented
9-Change Decreasing	Not yet implemented
10-At Interval	Simply send the report at the specified Min Interval. NOTE that low power modes may stop the reports from occurring at this rate
11-Lid Open	Trigger the report if the lid is opened
12-Local Low Battery	Trigger the report if the local battery drops below the specified voltage. The standard battery is lithium so a value of 3 is recommended here
13-External Low Battery	Trigger the report if the external supply voltage drops below the specified voltage
14-High Temperature	Trigger the report if the temperature measured on board rises above the specified temperature
15-Low Temperature	Trigger the report if the temperature measured on board falls below the specified temperature
16-Digital Input	Trigger the report on detection of the digital input
17-Any global error	Trigger the report if any of the following errors are detected: Sim Error, GPRS Network Error, Network Signal Level Low, T24 Timeout (No data from any module), Lid open, Realtime Clock Error, Watchdog and Interrupt errors.

Value/Limit

Enter the value or limit against which the trigger is tested.

From To

Some triggers are applied to particular input channels and can be applied to either a single channel or a range of channels. To apply the trigger to a single channel just enter the same channel in both the To and From fields. To cover a range enter the required To and From channels. Channels can either be entered by channel number or hexadecimal Data Tag. When entering a Data Tag ensure that you use 4 characters i.e. 0F45



*Unless Data Tags are manually changed on transmitter modules the random nature would tend to make entering a range of Data Tags useless.*



#### On transition Only

Here you can decide whether the reports are sent all the time the trigger result is true or only on a change of the result.  
i.e. if the trigger is a low battery and the transition setting is NO then the report will be sent at every Min Interval (Assuming not in low power mode) while the battery is low.  
If the transition setting is YES then the report will be sent once the battery becomes low and again when it is no longer low. The min interval still applies.

#### Min Interval

This is the minimum interval in minutes between deliveries of the report. The minimum number you can enter is 1.  
Unlike the data log and CSV send intervals these intervals are not tied to absolute time but are timed from the last sending of the report.  
Also bear in mind that in Low Power or Ultra Low Power modes reports could not be delivered more regularly than the Log Interval or the CSV Delivery Interval respectively.

---

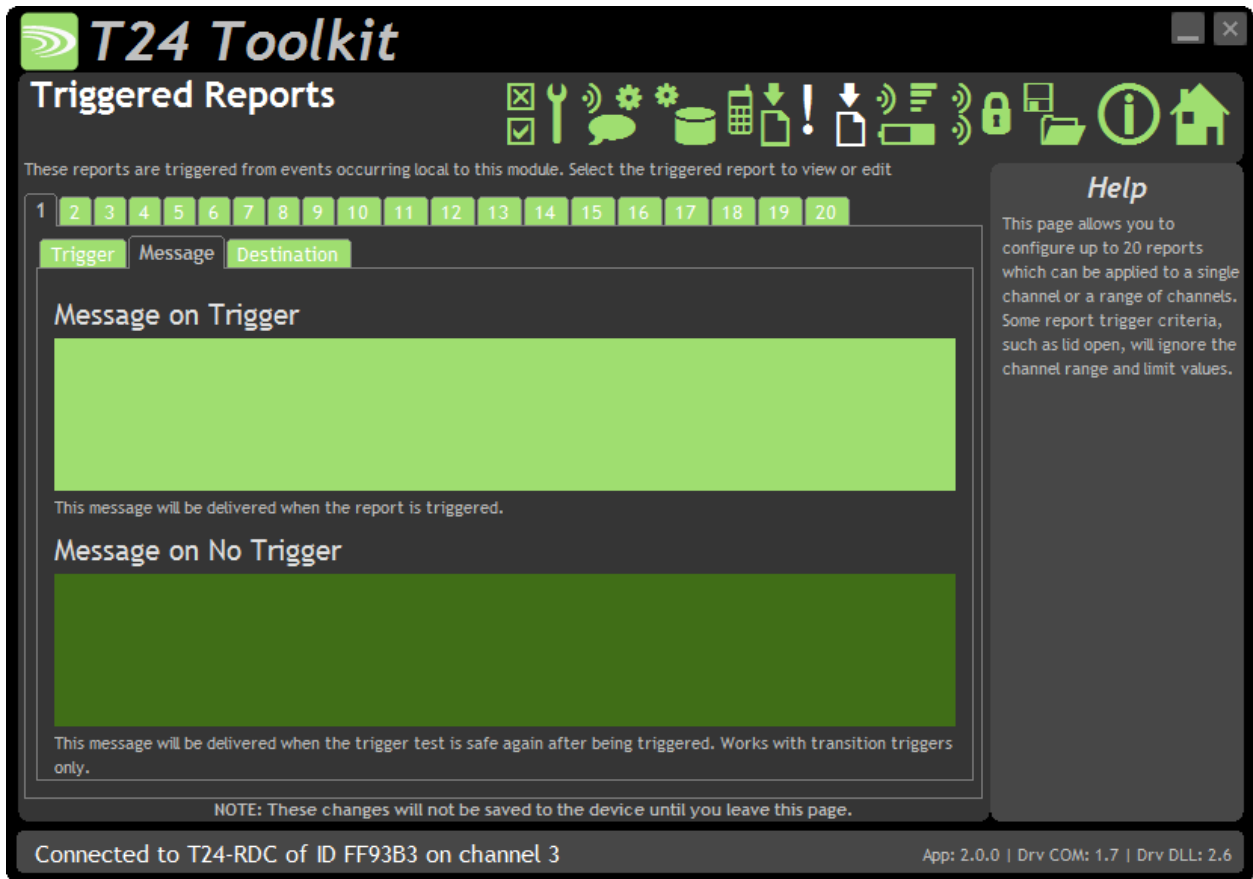

On the previous Trigger Tab you select whether the report is triggered transitionally or not. If triggered transitionally you can specify not only the message to send when the trigger test is true but also a message to send when the trigger test returns to false again.

In the above example you can see that the No Trigger message is disabled because this is not a transitional triggered report.

**Items you can change:**

Message On Trigger

Enter the report to send when the trigger test returns true. This report can contain tokens which get decoded to useful information when the report is transmitted. See [Tokens](#) later in the manual. For example the message for a report that is triggered on low internal battery may read:

```
WARNING: Internal battery low at <v> volts.
```

Message On No Trigger

On transitionally triggered reports this message is used when the trigger criteria is no longer met. For example a report triggered on low internal battery would send this message when the battery voltage is OK. i.e.

```
Internal battery voltage is OK at <v> volts.
```

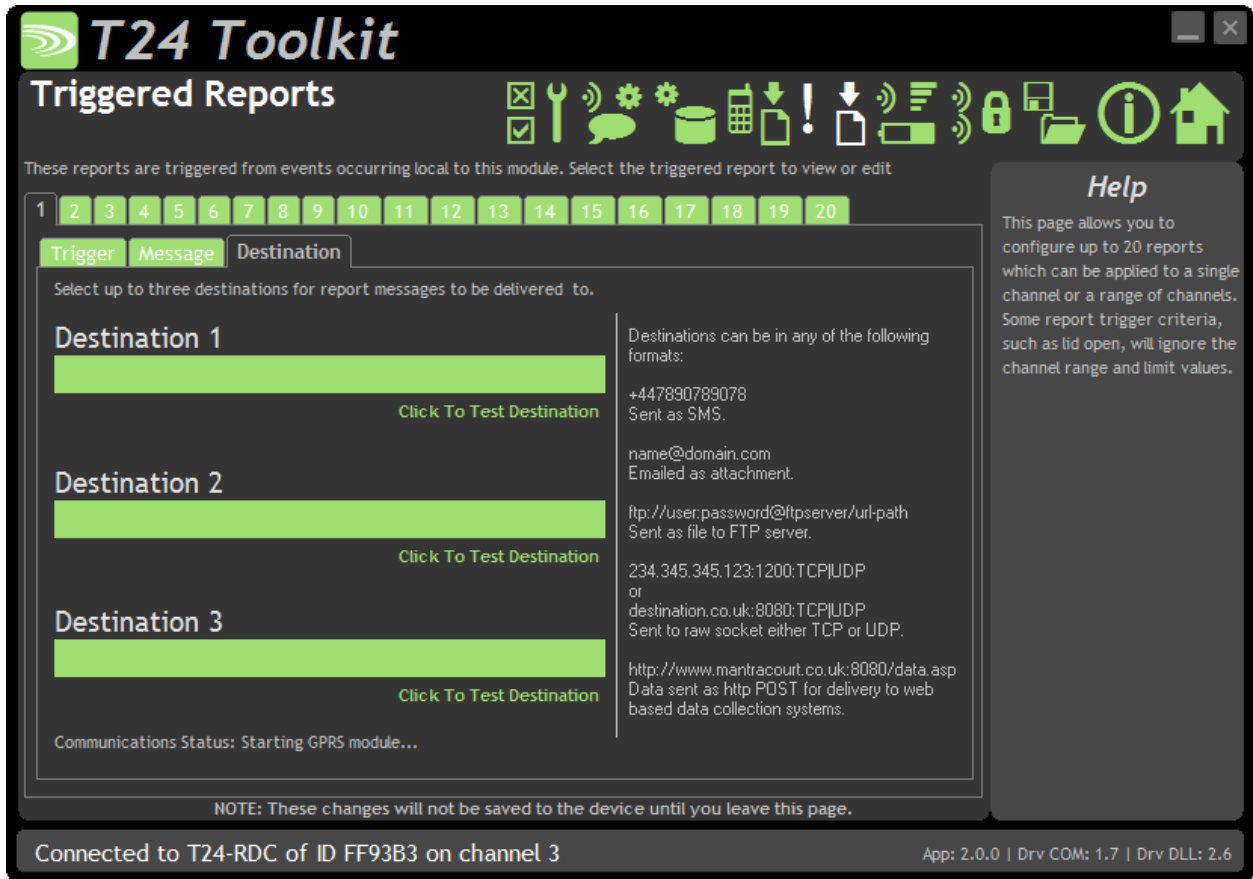

Here you specify up to three destinations for each report. All three destinations are attempted and you can leave any one blank if not required.

Destinations must be formatted as follows.

Type	Format
Email	mailbox@yourcompany.com
FTP	ftp://user:password@ftp.yourcompany.com/path
HTTP POST	http://webdata.domain.com/adddata.asp:8080
TCP	123.123.0.1:1002
SMS	+446789686723

See the [Destinations](#) section later in the manual.

Clicking the 'Click To Test Destination' link under each destination will cause the work TEST to be sent to the specified destination. See the lower part of the page for the status and result of this test. You will also need to check the actual destination for the delivered message to ensure that you have entered the correct details.

**Items you can change:**

**Destination Tab**

- Destination 1                      Enter the required destination.
  
- Destination 2                      Enter the required destination.
  
- Destination 3                      Enter the required destination.

## Tokens

Reports and some other fields make use of tokens. These are specific codes enclosed in triangular brackets '<>' that have certain meanings and are replaced with real data at the time that the report (or other parameter) is created.

On clicking a field that supports tokens a special editor window will appear.

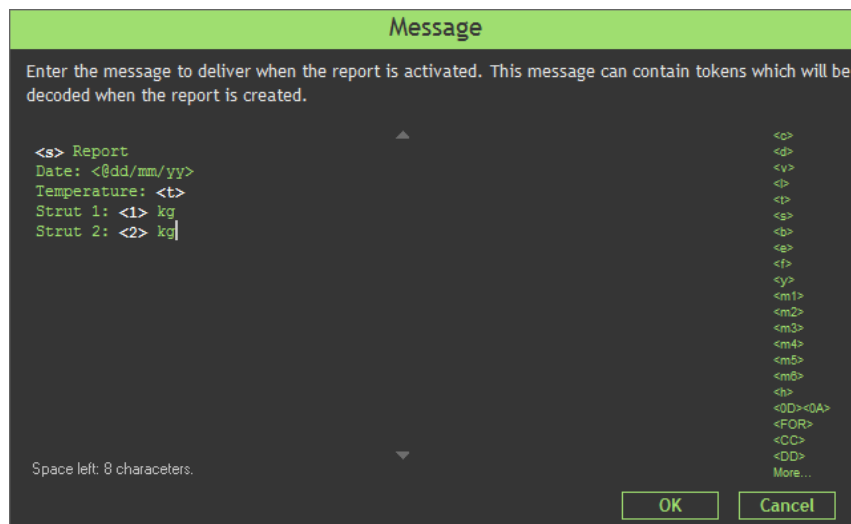

Although you can just type tokens in the window does list some common ones on the right hand side which you can double click to enter into the report. A single click shows a description of the token. Click More... to view all available tokens.

## Token List

Text in reports and alerts is decoded when required and tokens are replaced with live data. Tokens are not **case sensitive!**

Token	Description
<C>	Replaced with actual channel(s) causing a triggered report.
<D>	Replaced with actual data tag(s) causing a triggered report.
<V>	Replaced with the first value that triggered an alert (or the sum in the case of summed criteria reports).
<A>	Replaced with the time and date that the triggered report was triggered. This is useful because the report may not be delivered due to minimum delivery intervals or it may be the last report in a large queue. The format of the date time is the same as that configured for the CSV file.
<L>	Replaced with the value/limit value of a triggered report.
<T>	Replaced with internal temperature.
<nnnn>	Replaced with last value from specified data tag. i.e. <FC34>
<nn>	Replaced with last value from specified channel. i.e. <12>
<S>	Replaced with SiteName .

<B>	Replaced with local battery voltage.
<E>	Replaced with external battery voltage.
<F>	Replaced with the current FileCounter. Used primarily for filenames so a unique filename is generated each time a report, alert or CSV data is delivered as an email attachment or to an FTP server.
<Y>	Replaced with the type of message being generated. Either 'Report' or 'Data'. Used primarily for filenames so (because there is only one global filename defined) the filename can contain a reference to the type of data it contains. Used when a report or CSV data is delivered as an email attachment or to an FTP server.
<M1> through to <M6>	Replaced with the contents of the Macros entered in the System Macros page. Using macros offers two distinct advantages. <ol style="list-style-type: none"> <li>1. A single piece of text can be used in multiple reports and is editable in just 1 place and also changeable via SMS remote configuration.</li> <li>2. Increases the size of reports. Although each report has a limited length including macros can increase the length of the final output. Remember that macros cannot contain tokens.</li> </ol>
<H>	Replaced with channel health check summary. Channel error types are listed against a list of failed channel numbers. Example: <pre>Comms: 1,4 Battery: Error: 9 Integrity: 6,9-10,12</pre>
<FOR>	Indicates the start of the looped section. The section between the <FOR> and <EACH> tokens will be decoded once for each channel.
<CC>	Within a loop section this will be replaced with the channel number.
<DD>	Within a loop section this will be replaced with the data tag from the channel.
<0>	Within a loop section this will be replaced with the value from the channel (Contains a zero rather than a specific channel number).
<SS>	Replaced with the status value from the channel.
<FF>	Replaced with the flags value from the channel.

<p>&lt;EACH&gt;</p>	<p>Indicates the end of the looped section.</p> <p>Example of using the looping tokens. If the report contained the following:</p> <pre> Channel List ----- &lt;FOR&gt; Channel &lt;C&gt; [&lt;D&gt;] = &lt;0&gt; kg &lt;EACH&gt; </pre> <p>The result would read</p> <pre> Channel List ----- Channel 1 [FC23] = 123.45 kg Channel 2 [FC12] = 456.78 kg Channel 3 [FCE8] = 12.34 kg Channel 4 [FD5D] = 45.67 kg </pre>
<p>&lt;@dddd&gt;</p>	<p>tokens starting with @ character will be decoded to date time as described in <b>the Time Date Formatting</b> section.</p>

---

## Time Date Formatting

When defining filenames or using <@> tokens in reports and alerts the special time and data structures are defined by the following groups of case sensitive characters:

Element	Description
"yy"	The last two digits of the year (that is, 2009 would be displayed as "09").
"yyyy"	The full year (that is, 2009 would be displayed as "2009").
"mm"	The two-digit month number. Single-digit values are preceded by a zero.
"mmm"	The three-character month abbreviation.
"mmmm"	The full month name.
"dd"	The two-digit day. Single-digit day values are preceded by a zero.
"ddd"	The three-character weekday abbreviation.
"dddd"	The full weekday name.
"hh"	The two-digit hour in 12-hour format. Single-digit values are preceded by a zero.
"HH"	The two-digit hour in 24-hour format. Single-digit values are preceded by a zero.
"MM"	The two-digit minute. Single-digit values are preceded by a zero.
"SS"	The two-digit second. Single-digit values are preceded by a zero.
"TT"	The two-letter AM/PM abbreviation (that is, AM is displayed as "AM").
"ee"	The full time and date encoded numerically in the MS Excel format.
"EE"	Epoch format in milliseconds elapsed since 01/01/1970.

Any other characters will form part of the formatted output.

i.e. '<@mddd dd yyyy at HH:MM:SS>' would decode to '**January 15 2009 at 12:23:05**'

---

## Destinations

Where message destinations are required they can be any of the following:

---

### Email

The message is sent to the specified email address. Reports are sent as the body of the email. CSV data is sent as an attached file.

The format is

**name@domain.com**

Example

bill@mantra.com

---

### SMS Message

The message is sent as an SMS message to a mobile phone.

The format is

**+XX1234567890**

Where the +XX is the country code. Note that the leading zero from the mobile number is omitted.

Example

+447890309993

---

### FTP

The message is sent as a file to the specified FTP server.

The format is

**ftp://user:password@ftpserver/url-path**

Where the username and password to access the site must be included if required by the site.

Example

ftp://user1:letmein@filespace.mantra.com/incoming/data

**or**

ftp://filespace.mantra.com/incoming/data

---

### TCP Socket (NOT YET IMPLEMENTED)

The message is sent as a data to a TCP socket.

The format is

**DNSorIP:port**

Where you can use either the DNS name or the IP address.

Example

12.135.36.265:8080

**or**

info.mantra.com:1024

---

### HTTP Post

The message is sent as the data content of an HTTP POST. This is useful for getting data into a web service or site.

The format is



**http://domain:port/path**

Where you can use either the DNS name or the IP address.

Example

```
http://mantra.com:80/cgi-bin
```

**or**

```
http://mantra.com/adddata.asp
```

As this posts data the same way as does submitting data from forms in web pages etc. it is very easy to handle data delivered by this method into web sites and data collection systems. Design your message to just contain the parameters and values. i.e.

```
V1=<1>&V2=<2>&DATESTAMP=<@ddmmyyyy>
```

The module wraps up the other required header text to deliver the POST to the destination.

As an example if the destination was

```
http://host.com/Service/batch
```

and your report message was

```
V1=<1>&V2=<2>&DATESTAMP=<@ddmmyyyy>
```

The actual delivered data would be

```
POST http://host.com/Service/batch HTTP/1.0
Host: host.com
Content-Type: application/x-www-form-urlencoded
Content-Length: 40

V1=123.456&V2=456.789&DATESTAMP=31122010
```

Now the receiving destination just needs to deal with the parameters. For example if you delivered the above data to an ASP page URL then you can extract the data as follows

```
X = Request.Form("V1")
Y = Request.Form("V2")
Z = Request.Form("DATESTAMP")
```

### Custom Headers

You can add custom lines to the header (See [System page POST](#)) which will allow authorization details and other security information to be added to the HTTP header if the site you are posting data to requires it.

```
POST http://host.com/Service/batch HTTP/1.0
Host: host.com
Content-Type: application/x-www-form-urlencoded
CUSTOM HEADER ITEMS APPEAR HERE
Content-Length: 40

V1=123.456&V2=456.789&DATESTAMP=31122010
```

## Battery Life

Although the T24-RDC has an internal battery it is designed to be supplied from an external battery or power source.

The low power modes can make a big difference to battery life.

The following scenarios give a guide to battery life and the charts show how long the batteries of a given Ah capacity would last. In real use the full capacity of batteries may not be usable as the T24-RDC can only run down to 4.5 V. Operating temperature and self discharge of the batteries will also play a part.

### Scenario 1

Data is logged at an interval of 1 hour.

The sample time on waking (if relevant) is 2 minutes.

The interval for transmitting the CSV file to a single email destination is every 24 hours.

The average current drawn:

Low Power Mode	None	Low	Ultra
Milliamps	53	6.2	2.4

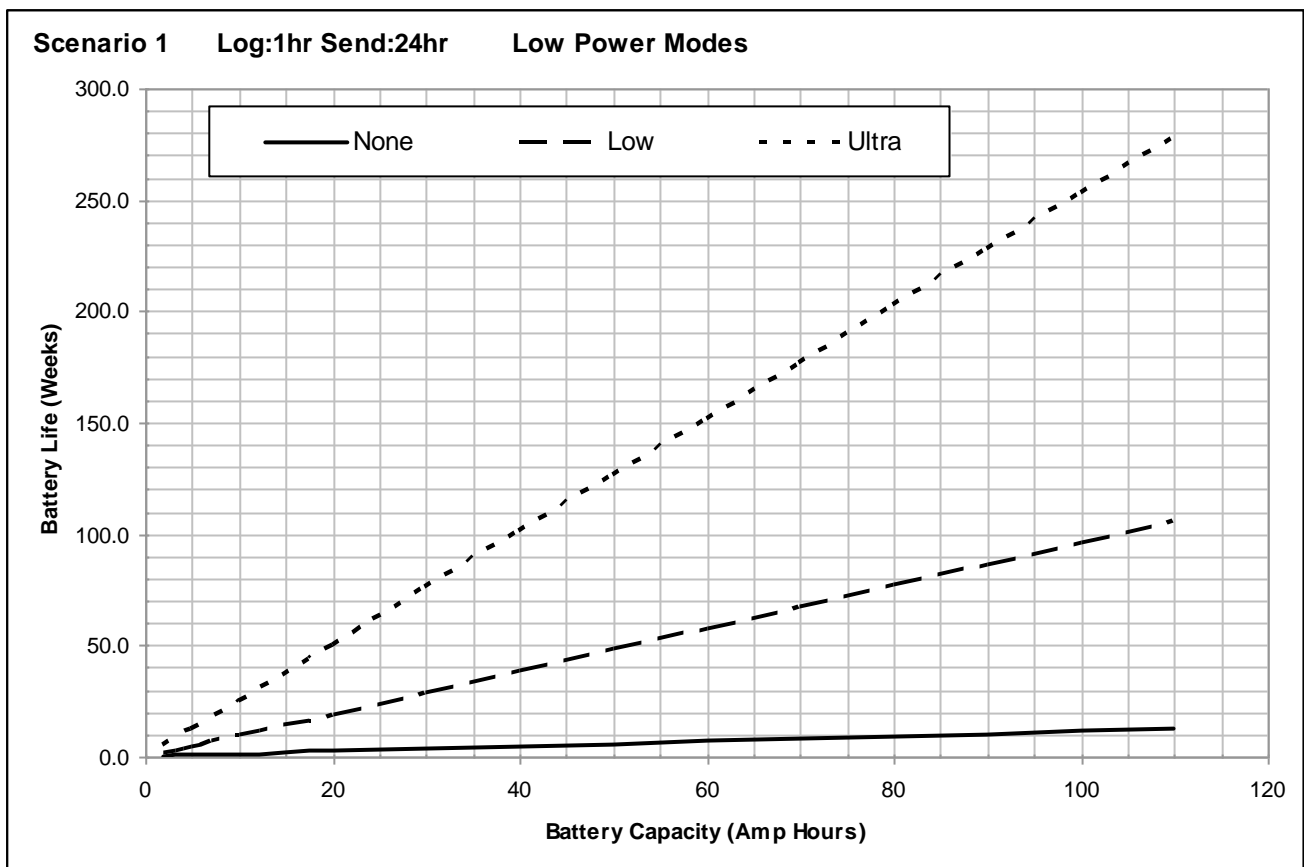

## Scenario 2

Data is logged at an interval of 15 minutes.

The sample time on waking (if relevant) is 2 minutes.

The interval for transmitting the CSV file to a single email destination is every hour.

The average current drawn:

Low Power Mode	None	Low	Ultra
Milliamps	53	11	9.4

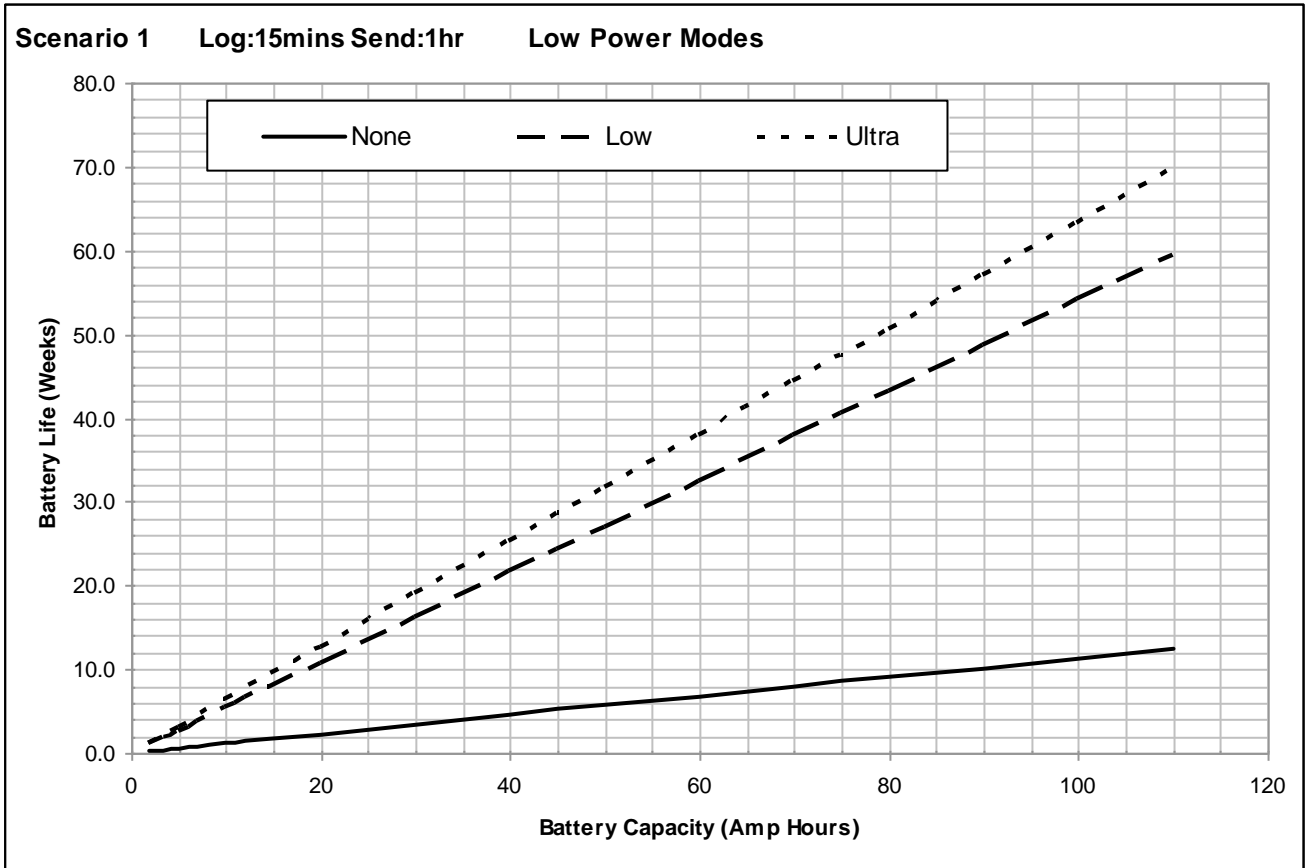

---

## SIM Card Considerations

---

### SIM Requirement

 SIM must be able to support host having only a 2G connection to the cellular network!

---

### Key Tariff Features:

- Internet Usage Costs
  - PAYG usually higher cost than contract per MB
  - Contract Included in monthly allowance
  - Fair Usage Allowance (5MB / day)
- SMS Allowance
  - Depending on Reports
- Call Credit
  - The T24-RDC does not require any air time minutes
- Robustness
  - Consider dedicated M2M SIM module contracts designed for machine to machine communications

---

### Pay As You Go SIM

- Top Up as you require must register for online top-up before sending out module
- Alternatively Direct Debit Top up when credit goes below £5
- Higher internet usage charges
- Lower Internet Usage Allowance / Fair Usage
- SIM card must be registered or network access is limited
- Some PAYG SIMS in some countries may prove less reliable than contract SIMs
- Large incoming text messages from providers can in some cases cause module freezes
- Cannot tell when credit runs out other than a break in service

 Only recommended for testing purposes as the stability of these SIMs is not robust enough for remote deployment.

---

### Contract SIM

- Constant Cost when SIM card not in use with T24-RDC
- Higher quality of service

 Only recommended for testing purposes as the stability of these SIMs is not robust enough for remote deployment.

---

### M2M Dedicated SIM

- Very robust
- Designed for use with machine to machine communications
- Voice data not required

 *This is the recommended SIM type for use in the T24-RDC modules.*

---

## Service Provider Settings for T24-RDC

### **Access Point Name (APN)**

Effectively the service provider website portal to give access to the internet

### **User Name & Password**

These are provided to give you access to the internet, the same provider may have different usernames and passwords for PAYG vs Contract customers to distinguish users.

## Service Providers

All service providers have different coverage, the below website allows you to check service providers coverage using your postcode as the reference location.

<http://www.gadgetstylist.com/blog/mobile-phone-coverage-check-your-mobile-coverage/>

The same network may get access to different types of internet connection, GPRS, Edge, 3G, HSDPA (High speed Downlink Packet Access) depending on location. The key difference between all these connection types is speed, hence time that the T24-RDC has to be awake. All of these connection types are viable and the T24-RDC will negotiate the best possible service for its current location.

## Service Provider Connection Details

Virgin Mobile	Property	Value
	APN	goto.virginmobile.co.uk
	Username	user
	Password	
	Notes	Virgin mobile PAYG has been used in the development of this product as the tariff offers good internet usage costs and the ability to spend all credit on SMS messaging.

Vodafone	Property	Value
	APN (Contract)	internet
	APN (PAYG)	pp.vodafone.co.uk
	Username	web
	Password	web
	Notes	Differing quality of service with contract vs. PAYG. The PAYG internet connection does not allow connections to pass through port 80, thus making posting to website impossible via port 80 rather port 8080 should be used.

  

T Mobile	Property	Value
	APN	general.t-mobile.uk
	Username	user
	Password	wap
	Notes	Regarded as one of the best mobile internet providers in the UK with highly flexible contract tariffs and some of the best HSDPA coverage. T-Mobile has some of the best coverage in the UK which is evident by the number of other companies that use their network Virgin and 3 included.

Orange	Property	Value
	APN (Contract)	orangeinternet
	APN (PAYG)	payginternet
	Username	user
	Password	pass
	Notes	Untested

Three	Property	Value
		3 SIMS are not compatible with the T24-RDC.

O2	Property	Value
	APN	mobile.o2.co.uk
	Username	mobileweb
	Password	password
	Notes	Untested.

Other Service Providers will use one of these main providers with a different tariff structure on top, i.e. Tesco Mobile, Fresh, Talk Talk.

---

## Simple Mail Transfer Protocol (SMTP) Servers

The T24-RDC requires the name or the IP address of an SMTP server as part of its configuration. The SMTP server delivers messages on behalf of the user; the T24-RDC can use the services of an e-mail provider that is not necessarily the same as the connection provider (ISP). This means the location of a client within a network or outside of a network, is not a limiting factor for e-mail submission or delivery, i.e. the same SMTP server can be used regardless of the ISP being used.

Some ISP's intercept port 25, so that it is not possible for their users to send mail via a relaying SMTP server outside the ISP's network using port 25; they are restricted to using the ISP's SMTP server. Some independent SMTP servers support an additional port other than 25 to allow users with authenticated access to connect to them even if port 25 is blocked. The practical purpose of this is that a mobile user connecting to different ISPs otherwise has to change SMTP server settings on the mail client for each ISP; using a relaying SMTP server allows the SMTP client settings to be used unchanged worldwide.

The SMTP service must support AUTH LOGIN authentication or allow unauthenticated access.



---

## SMTP Server Options

---

### Mobile Service Provider SMTP Servers

Most Mobile operators have an SMTP server for their customers to use, in many cases users create accounts on the mobile provider website that they can then access through their phone. The services are free however they are limited in the respect that only one email address is available to send mail from and it will generally end with the company's name, i.e. example@T-mobile.co.uk

---

### Other "Free" SMTP Servers

There are many 'free' SMTP service providers however nothing comes for free, each will have a catch. Either similarly to mobile provider SMTP servers you will only be able use a single email address with the companies name in it, or there will be very low usage allowance on the account.

---

### Your SMTP server

Most companies now have their own SMTP server as part of their IT infrastructure this can be used as a relaying SMTP server, however this does require the SMTP server to be exposed onto the internet. Obviously there is no running cost and no limit to the email addresses mail can be sent from, however it can pose a security issue for system administrators as it could be possible to configure the T24-RDC to overrun an SMTP server which could then in turn over run your company's SMTP server. In Addition some maintenance would be required if the senders email addresses were changed.

---

### Web Based Relaying SMTP server

Load Cell Central has gone down the path of outsourcing our SMTP server forwarding to a web based SMTP server. This allows us to send emails from any device from a PC to T24-RDC using any validated sender email address. Sending Email addresses are validated by the relaying SMTP server via an authentication email to the email account. The cost of this service is variable depending on the amount of data being sent; typically a service relaying 1000 emails with up to a total 1.0GB of attachments from up to 55 different email addresses per month will cost £100 per annum.

Using a relaying service removes any risk of using your company server as well as allowing you to choose a multitude of senders email addresses. Also by using a relay service it does not matter which service provider you are using. You can also check you service usage and adjust your price package online allowing easy management of the T24-RDC overheads.

---

### SMTP Server Providers

[www.authsmtp.com](http://www.authsmtp.com) (Mantracourt's Provider)

[www.smtp.com](http://www.smtp.com)

---

## Enclosure & Mounting

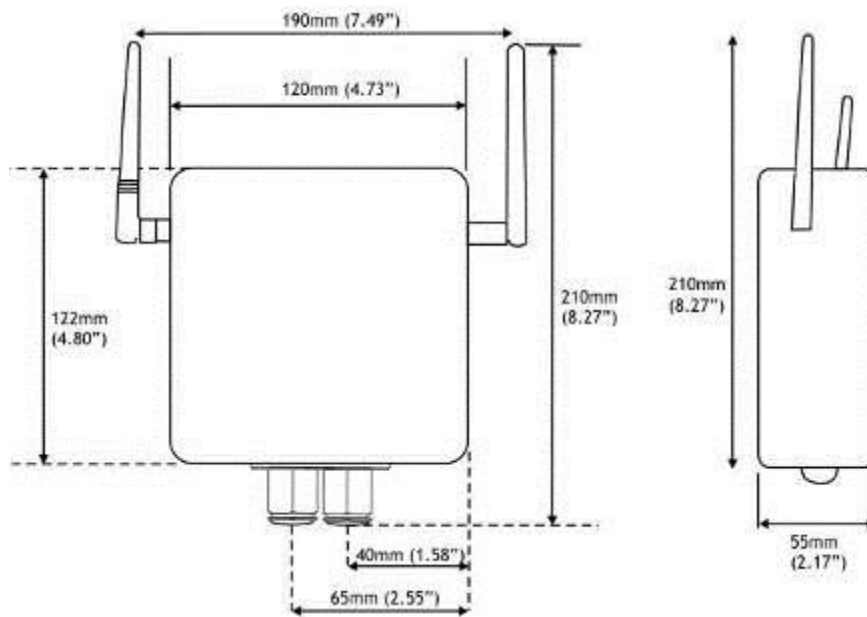

---

## Antennas

These modules have the antenna already fitted to the enclosure so there are no specific mounting requirements. However, the left antenna can be angled to give better T24 reception.

---

## Specification

Parameter	Minimum	Typical	Maximum	Units	Notes
External Supply voltage Range	9	12	32	Vdc	
Average Operational Current	-	350	500	mA	
Operating Temperature Range	-20	-	70	°C	
Storage Temperature Range	-20	-	70	°C	
Reverse polarity Protection		-	-32	Vdc	Maximum Supply level
Enclosure				Grey ABS	
Environmental Protection				IP67	
Dimensions				120 mm x 122 mm x 55 mm	

---

## Radio Range

To determine radio range please refer to [Appendix B – Antenna Range](#)

---

## Base Stations & Repeater Modules

Base stations are required for configuration of the T24 modules using the T24 Toolkit software. They are also used to supply data to PCs and PLCs.

Repeaters allow the effective radio range to be increased, allow better coverage and to avoid obstacles.

---

### T24-BSi, T24-BSu, T24-BSue

---

#### Overview

Base stations are the interface between the T24 radio system and a PC, PLC or other controller.

A base station would be required to configure T24 modules from a PC using the T24 Toolkit software and also required if you are to capture data from T24 modules to a PC or PLC.

---

#### Order Codes

---

##### T24-BSu



Base station with USB connection in non weatherproof enclosure. Ideal for indoor applications and for configuration.

##### T24-BSue



Base station in weatherproof enclosure with USB connection. This is a more robust housing with more range than the T24-BSu.

##### T24-BSi



Base station mounted in large weatherproof enclosure. This variant has RS232, RS485 connections along with USB. This variant is ideal for permanent outdoor installations.

---

#### Addressing

Usually only a single base station is required in a telemetry installation. If a telemetry module is outside the range of the base station a repeater may be deployed.

Some complex topologies may only be realized by using multiple base stations which may require changes to the **Address** switches. (See **Advanced Multipoint Base Station** Section)

The industrial base station (T24-BSi) has interfaces for USB, RS232 and RS485 and is addressable. The USB only base stations (T24-BSu & T24-BSue) have a fixed address of 1 so only one can be connected to a PC at a time.

---

---

## Connections

---

### T24-BSu & T24-BSue

These base stations simply connect to the USB port of a PC and are powered from the USB bus.

---

### T24-BSi

This diagram shows the available connections, switches and LEDs.

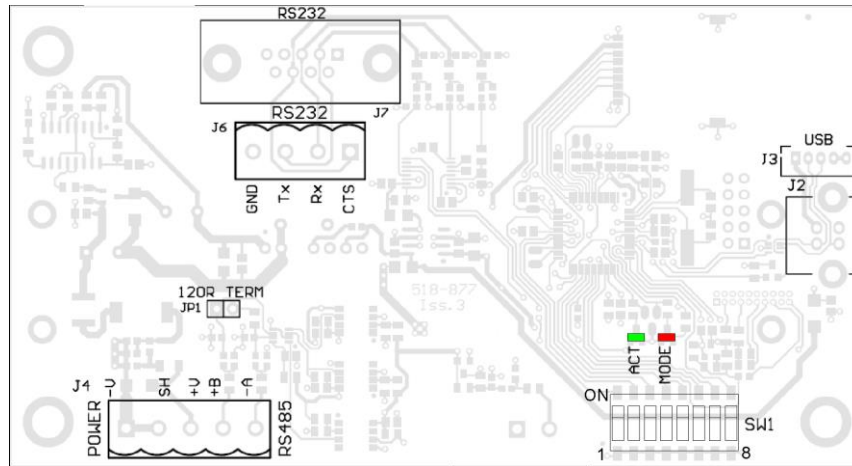

The interface can be selected from the DIP switches **SW1** as can baud rates for serial interfaces and the Address of the base station.

---

### SW1 Settings

#### Address

Switch positions 1 to 4 select the base station **Address**. This should normally be 1.

	1	2	3	4
Address				
1	Off	Off	Off	Off
2	On	Off	Off	Off
3	Off	On	Off	Off
4	On	On	Off	Off
5	Off	Off	On	Off
6	On	Off	On	Off
7	Off	On	On	Off
8	On	On	On	Off
9	Off	Off	Off	On
10	On	Off	Off	On
11	Off	On	Off	On
12	On	On	Off	On
13	Off	Off	On	On
14	On	Off	On	On
15	Off	On	On	On
16	On	On	On	On

## Serial/USB

Switch positions 5 to 7 set whether serial or USB is used. If USB is not selected then the chosen switch settings control the baud rate for the serial interface. Whether the serial interface is RS485 or RS232 is selected by switch position 8.

	5	6	7
<b>Baud rate / USB</b>			
USB	Off	Off	Off
9600	On	Off	Off
19200	Off	On	Off
38400	On	On	Off
57600	Off	Off	On
115200	On	Off	On
230400	Off	On	On
460800	On	On	On



*A baud rate of 9600 (and in some cases 19200) is not suitable for 2 way communication with remote modules as it is too slow and causes timeouts. This baud rate has been included to enable the base station to be connected to a 9600 baud device to allow low rate Data Provider packets to be received.*

*At any rate below 230400 it may be possible to lose packets at high data rates as the serial connection cannot keep pace with the radio transmissions.*

If USB is not selected as the interface (Switch positions 5 to 7) then this switch position selects whether the serial interface is RS232 or RS485.

	8
<b>232/485</b>	
RS232	Off
RS485	On

## Power

USB base stations will be powered by the USB bus. If RS232 or RS485 are selected then external power will need to be connected to J4 on the -V and +V pins.

## LED Indication

Two LEDs indicate Power/Mode and Activity.

The red LED indicates mode and should flash at a 2Hz rate. If any errors are detected with the radio then the LED will remain lit.

The green LED flashes once for each packet received or transmitted via radio, USB or serial.

## RS232

The RS232 interface uses TX, RX and GND to connect to a PC, PLC etc. and uses standard RS232 voltage levels. The baud rate can be selected by setting the DIP switches stated above.



*The base station will require power cycling to utilise a baud rate change.*

### Example connection to a PC 9 way D serial connector.

PC 9 Way D Plug Pin	Signal Direction	Base Station Connection	
3 (TX)	->	RX	J6 RX or J7 Pin 3
2 (RX)	<-	TX	J6 TX or J7 Pin 2
5 (Gnd)		GND	J6 GND or J7 Pin 5
8 (CTS)	<-	CTS	J6 CTS or J7 Pin 8

### RS485

The RS485 interface (This is a 2 wire 485 interface and will not work with 4 wire 485 buses) uses TX, RX and GND to connect to a PC, PLC etc. and uses standard RS485 voltage levels.

The baud rate can be selected by setting the DIP switches stated above.



*The base station will require power cycling to utilise a baud rate change.*

### Example connection

Depending on the RS485 interface or hardware the connections vary and are not standard therefore we can only show the connections to the base station. You must refer to the user manual regarding your RS485 connection to ascertain the correct connections.

PC / PLC Connection	Signal Direction	Base Station Connection	
Refer to RS485 Device User Manual		A	J4 -A
Refer to RS485 Device User Manual		B	J4 +B
Refer to RS485 Device User Manual		GND	J4 SH

### Serial Limitations

- When using RS232 or RS485 you should use the fastest baud rate possible. At lower rates data can be lost because it can arrive from the radio faster than the base station can send it serially.
- At 9600 baud you will experience communications problems when configuring modules. This baud rate is too slow for anything other than monitoring data provider packets from modules and even then these should be at a low rate (around 20 per second ). The slow baud rates are provided to get low rate data into older systems.
- RS485 is a bus master system and is not ideally suited to full communications with modules when multiple modules are providing data. This is fine for the normal operation of data transmitter but it is recommended that only the module to be configured is active during configuration.

### USB

Connection to the base station will be either a captive USB cable (T24-BSu & T24-BSue) or a USB socket B for connection using a standard USB A-B cable (T24-BSi J2). There is an optional cable assembly for the T24-BSi to provide for a USB connection while the module is still fitted to the ABS case (T24-BSi J3).

To communicate with the base station the connected module must use the USB HID Device Class and support USB 2.0 full speed interface (12Mbits).

The USB connection will also power the base station.

---

## Communications

In a lot of installations the base station is used to configure and calibrate the T24 modules by use of the T24 Toolkit software.

In this case the user needs only connect the base station to the PC by means of a suitable interface as described above. The Toolkit software can then be configured to use the desired interface to the base station.

If you intend to write your own software to connect to a T24 module please refer to the T24 Technical Manual for descriptions of communications protocols.



---

## Configuration

The T24 Toolkit provides a means of simple configuration and calibration of the transmitter module along with useful tools to aid integration.

Launch the T24 Toolkit software application and follow the instructions below (Home) to pair to the base station.

---

### Home

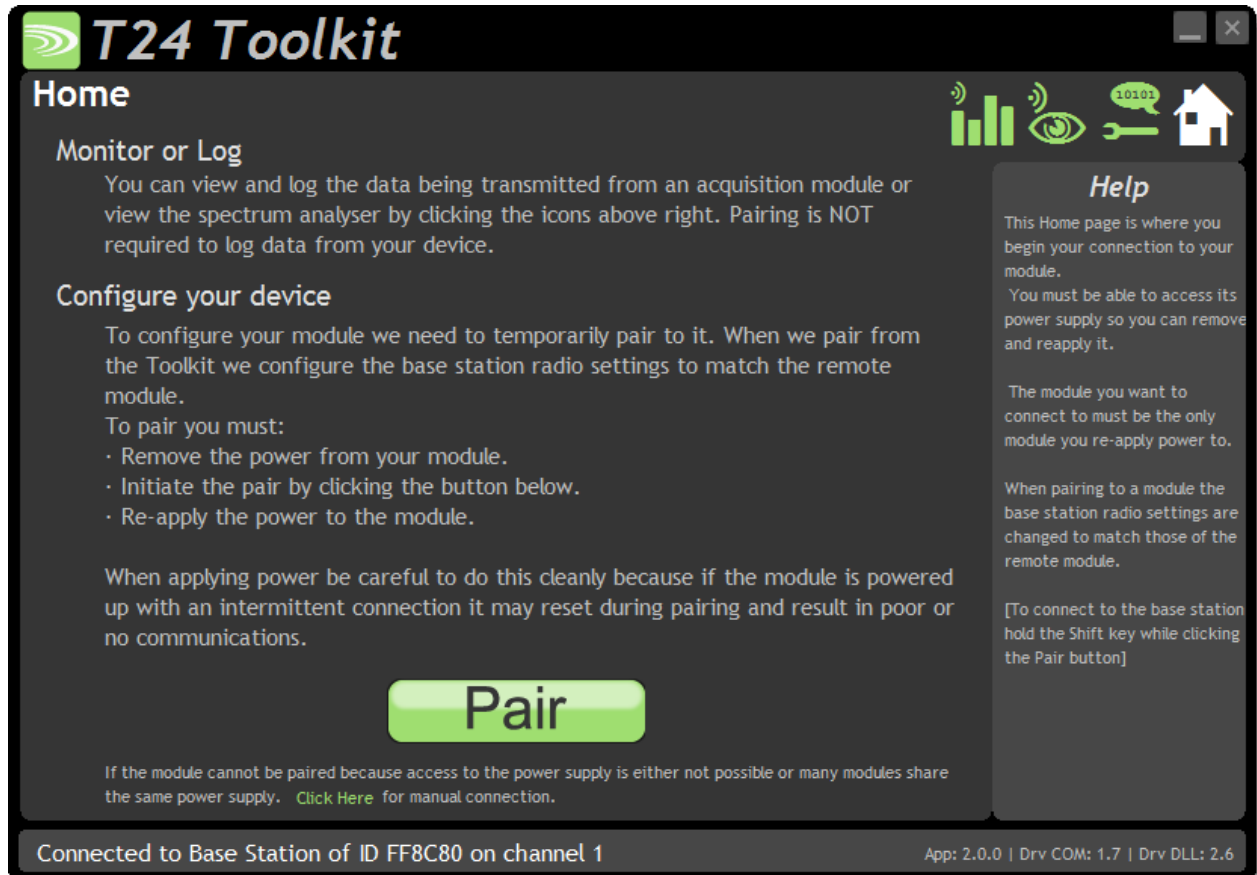

You now have successful communications with the base station so you can now let the Toolkit know you want to configure the base station and **not** a remote module.

**i** To connect to and configure the connected base station, hold the **shift key** and click the **Pair** button.

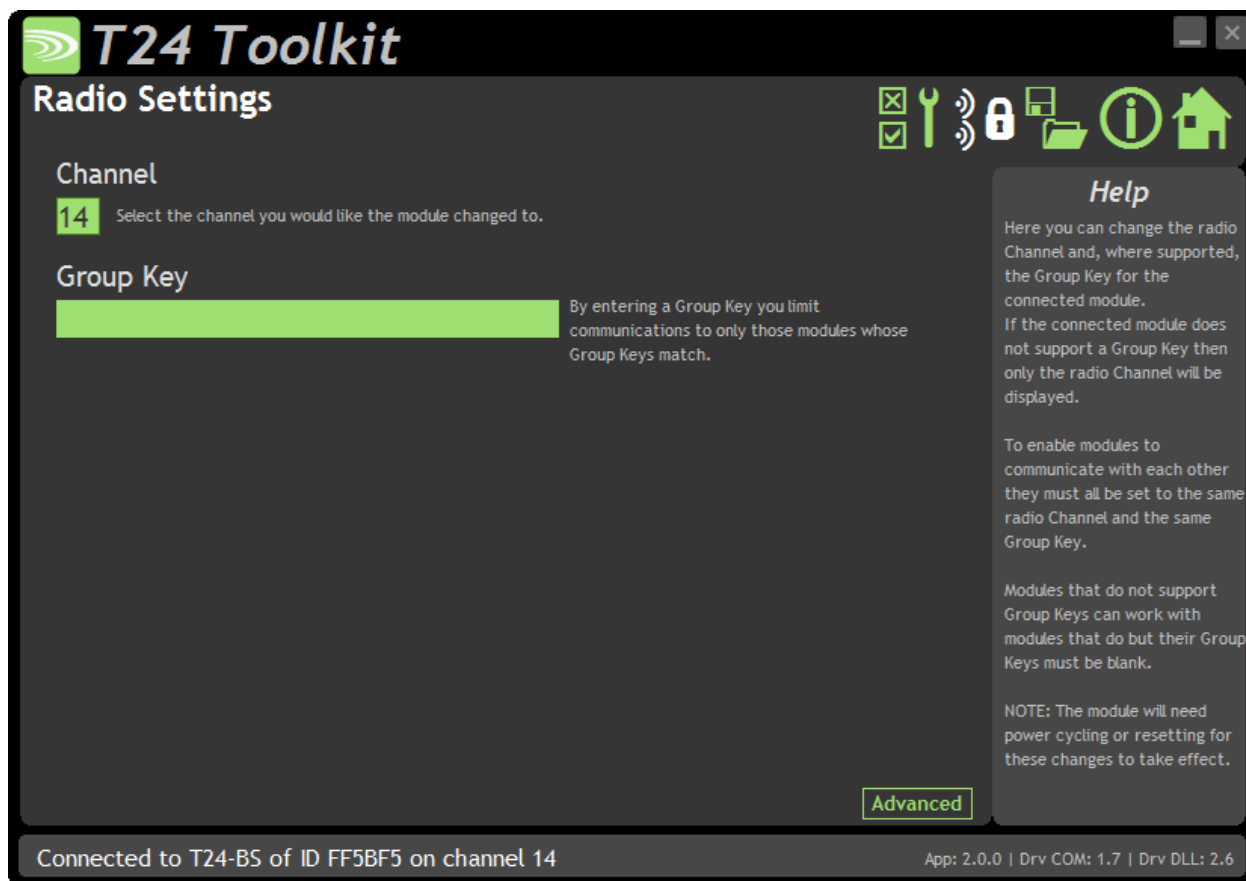

Here you can change the channel and group key for the base station. This may be useful if you intend to do any of the following:

- Communicate with the T24 modules using your own software
- Want to soft pair to a module.

**i** You do not usually need to change these settings because when you 'Pair' to a module to configure it, the base station is automatically configured to match the radio settings of that module.

**Items you can change:**

- Channel** Select a channel between 1 and 15. The default is channel 1. You can use the Spectrum Analyser mode to determine a good clean channel to use.
- Group Key** **This section will only be visible if the version of the base station supports Group keys.** Only modules with identical group keys can communicate. You can isolate groups of modules on the same channel or just use the key to ensure the data cannot be read by somebody else. **To use modules that support Group Keys with older modules that do not then the Group Keys must be blank.**
- Advanced** See [Advanced](#) Settings below.



You should not normally need to change these settings.

**Items you can change:**

Waker Duration	When you send a wake command to a T24 module via the base station the duration of this wake attempt is controlled by this setting. Enter the desired duration in seconds.
----------------	---

---

## Enclosure & Mounting

This module is available in a number of different enclosure types. Locate your module and follow the link to view dimensional and mounting information for that particular enclosure.

---

### T24-BSi

This module is fitted inside our large enclosure. Please see [Appendix A – Enclosures & Mounting – ACM](#) for more information.

---

### T24-BSue

This module is fitted inside our medium enclosure. Please see [Appendix A – Enclosures & Mounting – ACMi](#) for more information.

---

### T24-BSu

This module is fitted inside our small enclosure. Please see [Appendix A – Enclosures & Mounting – ACMm](#) for more information.

---

## Antennas

---

### T24-BSi, T24-BSu, T24-BSue

These modules have the antenna already fitted inside the enclosure so there are no specific mounting requirements.

---

## Radio Range

To determine radio range please refer to [Appendix B – Antenna Range](#)

## Specification

### T24-BSi

Parameter	Minimum	Typical	Maximum	Units	Notes
	<b>m</b>				
External Supply voltage Range	9	12	32	Vdc	
Average Operational Current	-	100	-	mA	At 12 V
Operating Temperature Range	-20	-	55	°C	
Storage Temperature Range	-40	-	85	°C	
Reverse polarity Protection		-	-32	Vdc	Maximum Supply
Environmental Protection			IP67		

### T24-BSu

Parameter	Minimum	Typical	Maximum	Units	Notes
	<b>m</b>				
USB Supply Range	4.875	5	5.125	Vdc	As defined by USB 2.0 Specification
USB Bus Powered Operational Current	-	100	-	mA	
Operating Temperature Range	-20	-	55	°C	
Storage Temperature Range	-40	-	85	°C	
Environmental Protection			IP50		

### T24-BSue

Parameter	Minimum	Typical	Maximum	Units	Notes
	<b>m</b>				
USB Supply Range	4.875	5	5.125	Vdc	As defined by USB 2.0 Specification
USB Bus Powered Operational Current	-	100	-	mA	
Operating Temperature Range	-20	-	55	°C	
Storage Temperature Range	-40	-	85	°C	
Environmental Protection			IP67		Does not apply to USB connector at cable end.

## Radio Range

To determine radio range please refer to [Appendix B – Antenna Range](#)

---

## T24-AR

---

### Overview

The T24-AR is an active repeater which will allow the T24 range of modules to span around obstacles or increase range or coverage.

The connectivity module provides a battery holder for a pair of alkaline 'D' cells and has regulator circuitry for an external power supply. The batteries can also be used to provide power in case of external supply failure.

The case is environmentally sealed to IP67.

The repeater will allow messages to be repeated once which could double the radio range under ideal conditions. Adding more repeaters will not increase range but can increase coverage.

---

### Order Codes

---

#### T24-AR



Active Repeater module mounted in large weatherproof enclosure with battery holder for two D cell alkaline batteries. Also has ability to be powered from external supply voltage.

---

## Connections

---

### Power

Power can be supplied by fitting two D cell alkaline 1.5 V batteries or the module can be supplied from an external 5 Vdc to 18 Vdc source.

In both cases you need to fit the JP1 power jumper to supply power to the module.

When powered from the external DC source the LED will illuminate.

If internal batteries are fitted when external power is applied the batteries will be utilized if external power is lost.

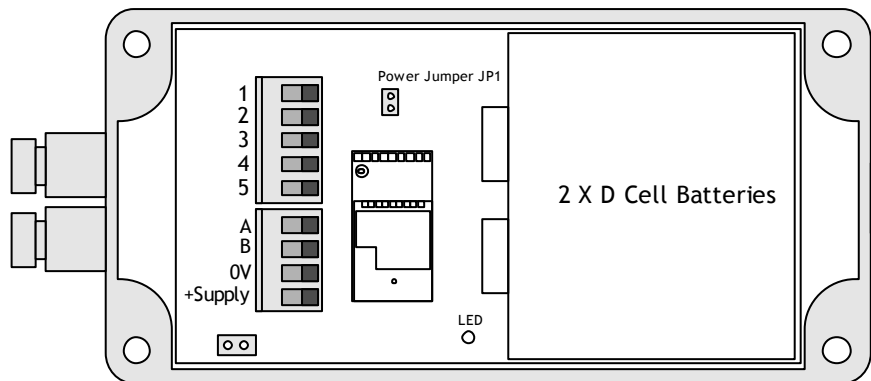

For battery information please refer to [Appendix D – Battery Selection](#)

---

### Power Options

The T24-AR can operate permanently powered or can operate from on-board batteries.

#### Permanently Powered

This is the simplest way to operate the repeater. With a permanent supply you do not need to worry about the repeater sleeping or waking. You can optionally choose whether the repeater always wakes sleeping modules and then you could utilise the powering up of the repeater to wake up those modules outside the normal radio range.

#### Battery Powered

In low power battery mode the repeater wakes from sleep when other modules are woken and will remain awake until it stops receiving Stay Awake messages. This will work transparently with most T24 instrumentation.

You just need to decide on the Sleep Delay for a battery powered repeater. This causes the repeater to enter sleep mode if it does not receive stay awake messages within the Sleep Delay time.

Stay awake messages are transmitted by handhelds, analogue output modules and PC software etc. so that when those items are turned off or disabled all other T24 modules will sleep when their Sleep Delay time elapses.

---

## Getting Started

Use the T24 Toolkit to ensure that the repeater radio channel matches the rest of the T24 modules. You will then need to decide whether the repeater is battery powered or permanently externally powered and whether it should always wake other sleeping modules when it is powered up and awake.

**KEY:**  **T24 Transmitter** *e.g. Aquisition Module*  **T24 Receiver** *e.g. base Station or Handheld*  **T24 Repeater** *T24-AR*  **Obstacle** *Building, wall etc*

---

## Increase Range

With No Repeater



With Repeater



## Span Obstacles

With No Repeater





With Repeater



---

Combined Solutions

Many Consumers

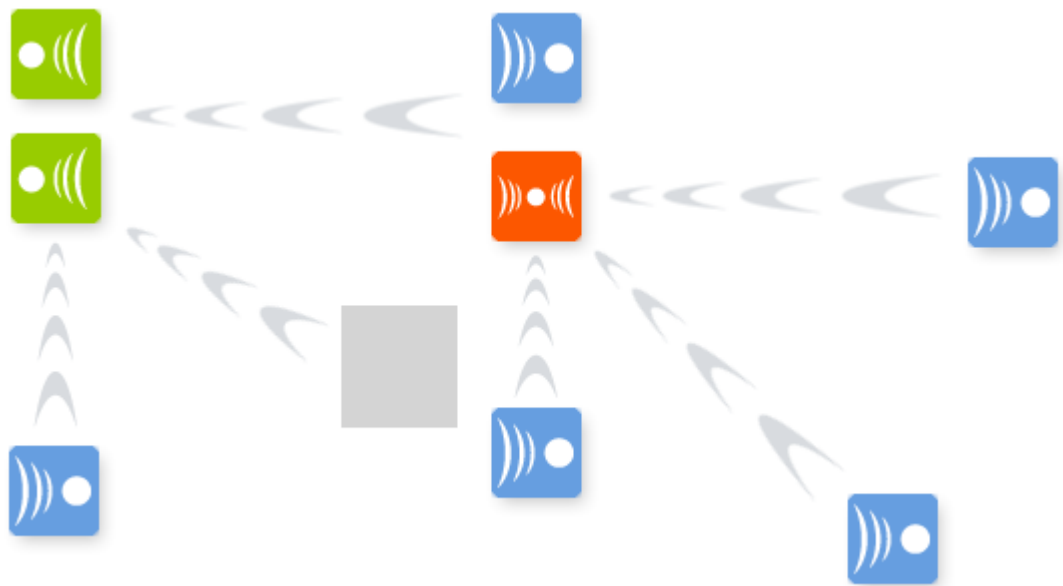

Many Providers



---

## Considerations

- Each repeater can effectively double the amount of traffic transmitted. Be careful not to introduce too many repeaters that are within range of each other as there may be un-necessary duplication of radio traffic. Carefully plan the layout of radio modules to minimise this.  
Using the Data Provider monitor in the T24 Toolkit can show the amount of traffic. The T24 Toolkit on a laptop or netbook is ideal for checking installations as it is mobile so traffic can be monitored at different points in the installation.
- A repeater will not repeat a packet that has already been repeated. Hence there is only one extra 'hop' introduced and a maximum range increase to 2X.
- When waking remote modules separated by a repeater and that repeater is asleep it may take twice as long to wake a module as when no repeater is involved.
- If the repeater is to be battery powered use the same Sleep Delay as is suitable for the transmitter modules in the system.
- You cannot pair to a module through a repeater although it **may** be possible to configure module through a repeater by [soft pairing](#). The results will vary depending on the number of repeaters and amount of radio traffic. In some cases it may be necessary to power down repeaters when configuring modules.
- Most data consumer modules and software issue a broadcast wake when turned on or activated and this will also wake a sleeping repeater which will then proceed to wake those modules within its range. But some modules only wake specific single target modules such as the T24-HS handheld module and the T24-AO1 analogue output module. For these modules to wake the repeater they must be fitted with at least version 2.1 radio modules. This only affects repeaters with a SleepDelay set.

---

## Configuration

The T24 Toolkit provides a means of simple configuration and calibration of the transmitter module along with useful tools to aid integration.

Launch the T24 Toolkit software application and pair to this module to enable the connection to the Toolkit to allow configuration to take place. [See Common Toolkit Pages - Home](#)

---

## Settings



Here you can change the settings for the repeater.

### Items you can change:

- Always Wake** In some cases where the repeater is manually powered on and off you may want it to wake all sleeping modules within its range. Set this option to Yes to enable this. The modules you wake should have their own Sleep Delay settings set so they go back to sleep after stopping receiving Stay Awake messages from the data consumer (PC or handheld).
- Sleep Delay** If the repeater is to be battery powered and you want to operate in low power mode you can employ this delay. Once the repeater stops hearing Stay Awake messages from the data consumer (PC or handheld etc.) it will go to sleep after this amount of time. The repeater will wake when any other module is woken.

## Battery Low Level

Select the battery voltage below which the repeater will report a low battery. It does this by making all repeated modules report a low battery so the data consumer (a handheld or PC software etc.) will be able to detect a problem. The battery level applies to the voltage seen after 3 V regulation. The default is 2.2 V and can be left at this when the repeater is powered externally.

If the repeater is battery powered and you wish to disable this feature select 2.0 V

---

## Enclosure & Mounting

This module is fitted inside our ACM ABS enclosure. Please see [Appendix A – Enclosures & Mounting – ACM](#) for more information.

---

## Antennas

These modules have the antenna already fitted inside the enclosure so there are no specific mounting requirements.

## Specification

<b>Environmental</b>	<b>Min</b>	<b>Typical</b>	<b>Max</b>	<b>Units</b>
Operating Temperature Range	-40		+85**	°C
Storage Temperature	-40		+85	°C
Humidity	0		95	%RH
Environmental protection with suitable cables exiting through cable glands.		IP67		

\*\*Batteries used may have reduced operating temperature range.

<b>Power Supply</b>	<b>Min</b>	<b>Typical</b>	<b>Max</b>	<b>Units</b>
Standby / Low Power Mode		5	20	µA
Normal Mode on constantly		55	60	mA
Reverse Polarity Protection		-32		Vdc
<b>Internal</b>				
Battery Supply Voltage	2.1	3	3.6	Vdc
<b>External</b>				
Power Supply voltage	5		18	Vdc
Power Supply ripple			50	mV ac pk-pk

<b>Battery Life</b>	<b>Typical</b>	<b>Units</b>
Battery life using Duracell LR20 'D' cells with the T24-AR permanently activated. **	228 (10)	Hours (Days)

\*\*Usually using batteries the T24-AR would be utilising the SleepDelay to return to sleep. Therefore the actual daily usage would allow for far greater than the stated battery life. For example: If the T24-AR was used for 1 hour per day then the battery life would be 6840 hours or 288 days or nearly 10 months.

# Power Supply Modules

## T24-BC1

### Overview

The T24-BC1 is a battery charger and power supply suitable for the T24 range of 3V transmitter modules. The T24 Battery Charger is designed to supply a constant 3.3 V from a Li-ion Battery while also charging the battery from an input voltage. The unit comes pre-configured to provide a charging current of 466 mA suitable for VARTA LIP653450. This module also supports additional batteries providing a charge current of 133 mA via the removal of the leaded resistor (non surface mount).

### Physical Connections

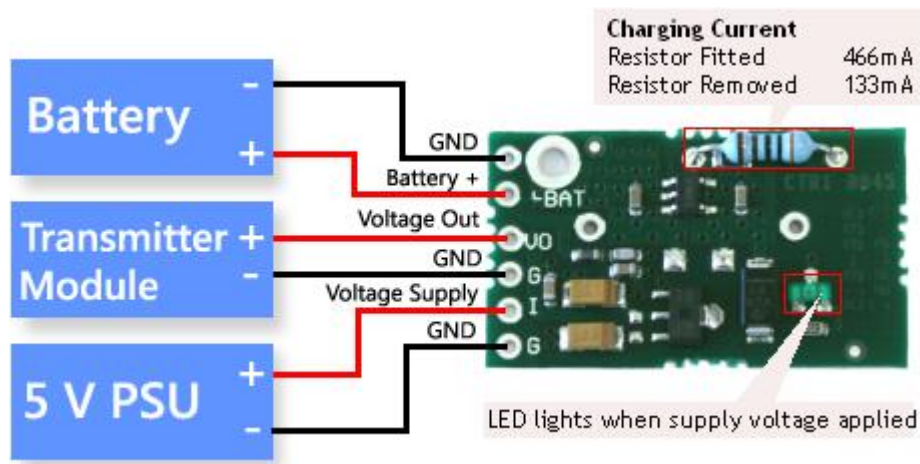

### Specification

Parameter	Min	Typ	Max	Units
Supply Voltage	4.1	5	6	Vdc
Regulated Voltage Output	-	3.3	-	Vdc
Battery positive connection	-	3.7	-	Vdc
Maximum Cable Length	-	-	150 *	mm
Quiescent Current	-	1.7	-	$\mu$ A

\* 07/02 gauge wire attached to maximum load i.e. T24-SAf with four 350 ohm strain gauges

Note LED will only be lit when an input voltage is applied

---

## Example Batteries

---

### VARTA LIP653450

- Rated Capacity: 1100 mAh
- Dimensions: 35 x 54 x 7 (mm)
- Weight: 20 g
- Charge Time : 3 Hours @ 466 mA
- Battery life = 3.3 days\*



---

### VARTA LIC18650

- Rated Capacity: 2200 mAh
- Dimensions: 18.25 Diameter 65 mm Height
- Weight: 46 g
- Charge Time : 4.5 Hours @ 466 mA
- Battery life = 6.5 days\*



---

### UBC 581730

- Rated Capacity: 250 mAh
- Dimensions: 18 x 31.5 x 5.8 (mm)
- Weight: 6.5 g
- Charge Time : 2 Hours @ 133 mA
- Battery life = 18 hours \*



\* Battery life is calculated with a T24-SAf running for 2 hours out of every 8 hours, to a 1000 ohm bridge.

---

## PP1 & SP1

---

### Overview

The Power Pack (PP1) & Solar Panel 1 (SP1) provides dependable off-grid power generation and storage to support a variety of T24 products.

Packaged in an IP67 sealed case with rugged waterproof connectors the PP1 has two sources of charge for the internal battery with both solar and mains power input charging. The case also features Stainless steel padlock protectors for easily securing your supply on site.

The PP1 has a single 12 volt fuse protected output. The mating connector comes pre-fitted with 5 metres of cable and bare end connections.

The solar panel features hail-proof tempered glass and closely packed polycrystalline cells, sealed into a robust aluminium frame. The junction box on the rear of the panel does not protrude beyond the frame, so installation can be simple and neat. The solar cell comes with 5 metres of cable as standard.

The SP1 & PP1 combined are designed to provide a perpetual power supply for a 12 V system drawing an average of 53mA, even during winter.

The PP1 can also be used as a mains powered 12 Vdc supply with 33 Ah battery backup.

---

### Order Codes

---

#### PP1



Power pack 1 housed in robust weatherproof case.

#### SP1



Solar panel with cable suitable for connection to PP1



---

## Getting Started

It is important when using the PP1 in any configuration that the connections are made in the following order:

1. Connect the 12V output lead to the device you wish to supply. The PP1 is provided with a 5 metre 12V output cable, this cable has the IP67 connector which mates with connection 3, see below. The cable is bare end terminated the red wire is positive and black is ground. Ensure the bare end connections are made before attaching to the PP1.
2. Connect the Solar Panel. The solar panel is supplied with a 5 metre cable terminated with the IP67 connector which mates with connection 1, see below.
3. Connect 100-240V supply (if necessary) The PP1 is supplied with a 0.8 m mains cable with a 13 amp plug. The battery inside the PP1 will be supplied fully charged.



---

## Power Pack 1 Connections

1. Solar Panel Input
2. 100 – 240 volt AC input
3. 12 volt DC Output
4. 6.3 amp Anti-surge Fuse

---

## Installation

### Connecting Power Pack 1

All connectors on the SP1 and PP1 are IP67 rated when correctly mated. The PP1 case is also IP67 rated meaning it is protected against the effects of temporary immersion in water between 15cm and 1m for no longer than 30 minutes. Dust caps must be fitted properly if the connection is not being used. If possible avoid positioning the PP1 in direct sunlight to limit temperature effects on the battery.

The connections for the solar panel input and 12 volt output feature a locking collar to ensure the connection is sealed. To insert remove the dust cap and align the connector and insert; there is a locating ridge to ensure correct orientation. Once inserted, twist the collar clockwise to lock in place. The connectors for the solar panel and 12 volt output are opposite gender preventing incorrect connections.



The PP1 110 Vac – 240 Vac input has a sealing cap for when it is not connected to the mains. The sealing cap is removed by pushing the outer sleeve towards the case and pulling the cap out.



To insert the mains cable input simply align the two parts using the locating grooves on the connector and push in until the outer sleeve locks; to remove again repeat the same procedure as to remove the sealing cap.

---

### Solar Panel Orientation

The SP1 is supplied on a mounting plate which when assembled with the horizontal support holds the panel at 50 degrees. The bracket is designed to be mounted on a pole or directly onto a wall.

For detailed panel angle information based on country and location see Solar Electricity Handbook calculator here: <http://www.solarelectricityhandbook.com/solar-angle-calculator.aspx>



When positioning the solar panel it should always face true south if you are in the northern hemisphere, or true north if you are in the southern hemisphere. True north is not the same as magnetic north. If you are using a compass to orient your panels, you need to correct for the difference, which varies with location. Search the web for "magnetic declination" to find the correction for your location.

Also consider where shadows may fall on the solar panel, the panel needs maximum exposure to the sun to operate as specified.

---

## Operation

The PP1 and SP1 combination was designed to supply a 12 volt system with a maximum continuous average current consumption of 53mA. The power rating of the system would be 0.636W; if used 24 hours per day this would equate to 15.264 Watt-hours. On an average British day, this power could be produced by a solar panel array of approximately 6 watts. However, you do of course get more power in the middle of summer than in winter. In summer you could produce that power required with only 3 watts of solar panels. In winter you would need 15 watts of panels to produce enough power. Hence the SP1 20W panel is more than adequate.

The output from the PP1 is fuse protected by a 6.3 amp anti surge fuse, this is to protect against short circuit on the output, fuses are 6.3A 20x5 mm ceramic glass tube type. The 100-240 Vac input charger is fuse protected in the 13 amp plug, if this plug is replaced with any other connector please consider how your PP1 is protected.

## Dimensions & Weight

PP1 Dimensions	339 x 295 x 152 mm
PP1 Case materials	Polypropylene
PP1 Weight	13 kg
SP1 Dimensions	360 x 510 x 28 mm
SP1 Frame Material	Aluminium
SP1 Weight	3 kg



PP1



SP1

## Specifications

Electrical	Min	Typical	Max	Units
Output Voltage		12		Vdc
Internal Capacity		33		Ah
External Power Supply Voltage	100	-	250	Vac
Input Frequency	47	-	63	Hz

Cable Lengths	Typical	Units
12 V Output Cable to Bare End	5	m
Solar Panel to Power Pack	5	m
Mains Charging cable *	0.8	m

\* Supplied with 13 A Plug

Environmental	Min	Typical	Max	Units
IP rating		IP67		
Operating Temperature Range **	-20		+50	°C
Storage Temperature	-20		+50	°C
Humidity	0		95	%RH

\*\* When being charged from Mains min operating temperature 0 °C max operating temperature 40 °C

---

# Appendices

---

## Appendix A - Enclosures

---

### OEM Transmitter Modules

---

#### Dimensions

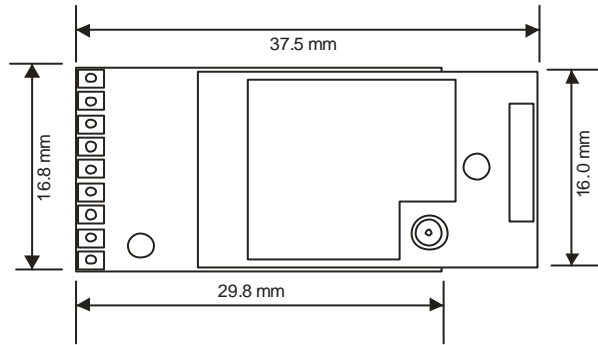

Height is 6.6 mm

---

#### Opening the Case

These modules are not housed in an enclosure.

---

#### Mounting Information

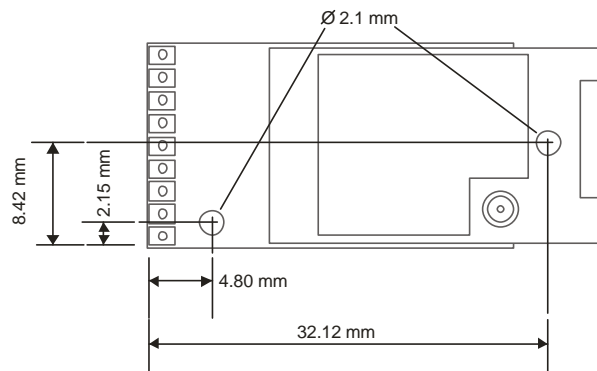

There are two holes available for mounting. The one nearest the connection pads can accept an M2 screw or American equivalent #0-80.

**!** DO NOT USE #2 screw size.

Note that the mounting hole is connected directly to the Battery ground of the transmitter module. The mounting hole near the chip antenna cannot accept metal mounting hardware. The connection holes are on a 1.9 mm pitch and are a diameter of 1.0 mm.

---

## Antenna Position

Modules that use an external antenna can be mounted anywhere but the mounting of the antenna will have restrictions. See the appropriate section in [Appendix B - Antennas](#)

Modules with an internal chip antenna have the antenna at one end of the board with the metal can on.

---

## Environmental Protection

These modules are not protected against the environment.

---

## ACM Type



---

## Dimensions

This ABS enclosure measures 164 mm X 84 mm and 57 mm deep. There are three positions for cable glands; two at one end and one at the other. Different modules may have a different number of glands fitted.

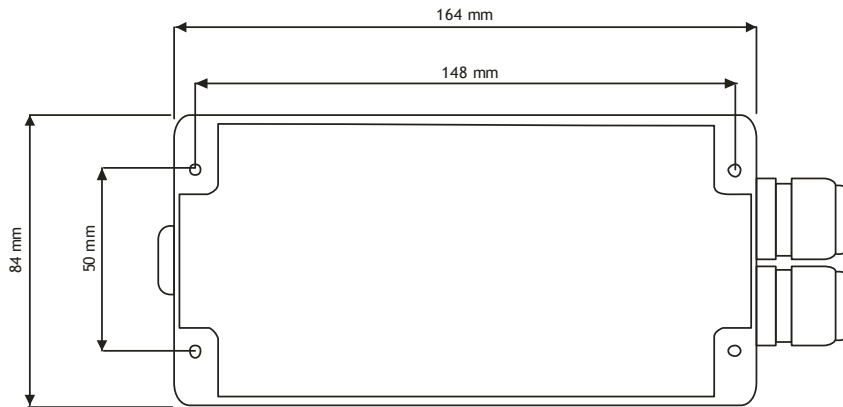

---

## Opening the Case

The case lid is secured with 4 x ¼ turn quick release screws. Using a flat head or Phillips screwdriver push down and turn each screw by 90° anticlockwise to release.

---

## Mounting Information

This enclosure is designed to be mounted to a surface. It is secured by holes on a 148 mm X 50 mm rectangle. The mounting holes are accessible once the lid has been removed and these are outside the sealing mechanism. Mounting holes have a diameter of 4.1 mm and can accommodate a screw head diameter of 6.8 mm.

---

## Antenna Position

The module is fitted with a T24-ANTA antenna which is mounted on the inside of the long side of the base on the opposite side of the enclosure to the metallised polyester label visible on the outside.



---

## Environmental Protection

The case is environmentally sealed to IP67 when cables of the correct diameter have been used. The cable diameter can range from 4 mm to 8 mm. Cables of a smaller diameter may be used if sleeved to increase their diameter.

When mounting the enclosure outside the cables should be dressed to provide a drip loop.

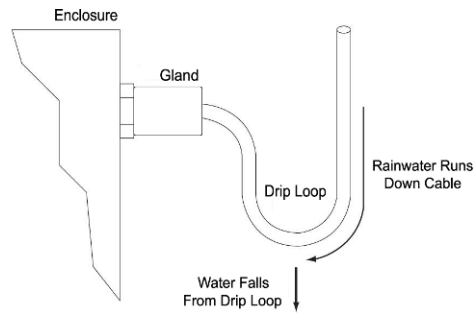

The sealing gasket resides in the lid. Be careful when replacing the lid that there are no dirt particles on the lower case lip or in the lid gasket channel as this may reduce the sealing capability.

---

## ACMi Type



---

### Dimensions

This enclosure is 76.6 mm X 59 mm and 31 mm deep. The gland extends a further 25 mm from one long side.

---

### Opening the Case

The case lid is secured with 4 x #2 cross head screws, remove the four screws and lift lid.

---

### Mounting Information

The enclosure has two mounting holes as shown below; these mounting holes are external to the seal but still covered by the case lid to offer fixings for some environmental protection. In addition mountings can be made through the back of the case however a seal or gasket must be used to maintain environmental protection.

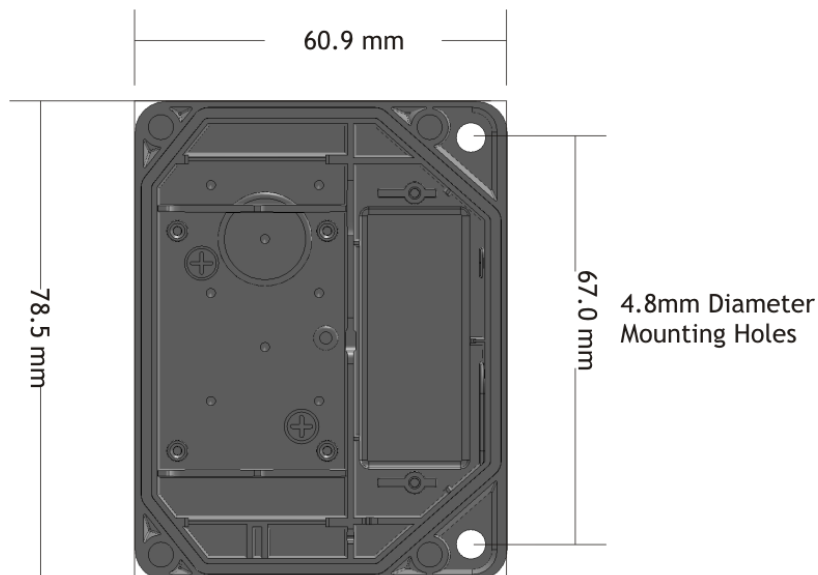



The antenna feeder cable and load cell connection cable must not be routed over, or near, the cross hatched area on the antenna shown below as this will affect range.



## Antenna Position

This enclosure is fitted with a T24-ANTA antenna which sits over the wiring access chamber and is covered by the enclosure lid.

## Environmental Protection

The case is environmentally sealed to IP67 when the correct cable diameters are used.

The sealing gasket resides in the base. Be careful when replacing the lid that there are no dirt particles on the gasket channel or lid as this may reduce the sealing capability.

The cable diameter can range from 3.0 mm to 6.5 mm. Cables of a smaller diameter may be used if sleeved to increase their diameter.

When mounting the enclosure outside the cables should be dressed to provide a drip loop.

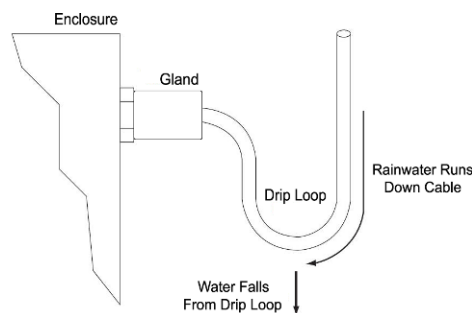

---

## ACMm Type



---

### Dimensions

This ABS enclosure measures 76.3 mm X 35 mm and is 20 mm deep.

---

### Opening the Case

The case lid is secured with 2 x Philips head screws, remove the screws and the case will come apart.

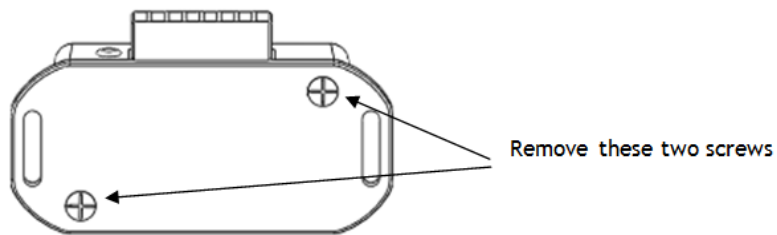

---

### Mounting Information

The enclosure can be surface mounted using two screws through the slots on each flange. The screw diameter can be up to 3.3 mm and the head diameter up to 8.0 mm. The distance between the mounting holes is 67.8 mm.

---

### Antenna Position

If the enclosure contains an antenna this will be of the chip type and could be at either position inside the enclosure as indicated by the black rectangles shown below.

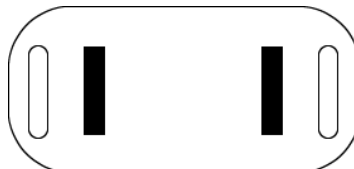

---

### Environmental Protection

This enclosure is not weatherproof.

---

## Handheld Type



---

## Dimensions

This ABS handheld case is 152 mm X 90 mm and 34 mm deep at its highest section.

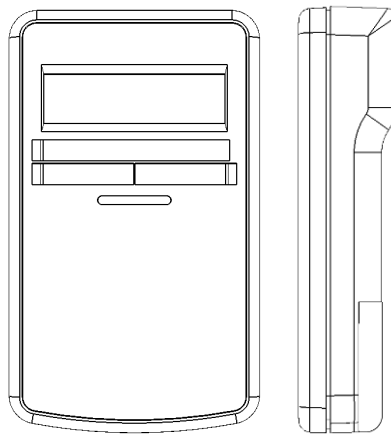

---

## Opening the Case

The battery compartment is secured with two Philips head screws.

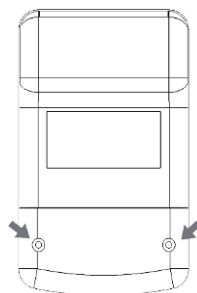

Once the battery compartment has been removed this gives access to two further screws which can be removed (along with the two at the top end) to allow the entire case to come apart. This gives access to the legend channels where cardboard legends can be slipped in behind the transparent label windows where supported. Note that the top two screws will have rubber 'O' rings on them. These rings are an integral part of the sealing mechanism.

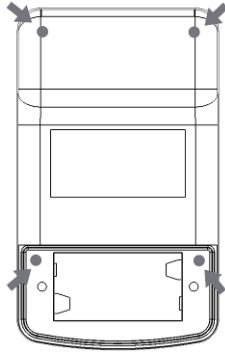

When the case comes apart be careful of any wires running between the two case halves.

---

### Mounting Information

There are no mounting options on the handheld enclosure.

---

### Antenna Position

The enclosure is fitted with a T24-ANTA antenna which is mounted in the top end of the enclosure.

---

### Environmental Protection

The enclosure is sealed to IP67. Ensure gaskets and mating parts are free from dirt and debris when re-assembling.

---

## Appendix B - Antennas

---

### Overview

Radio performance at microwave wavelengths is very dependent upon the operating environment; any structure within the operating region of the radios will give rise to three effects:

**Obscuration.** Obscuration will result in reduced range and occurs when an obstruction masks the line-of-sight between radios.

**Aberrations to the horizontal and vertical space patterns.** Distortion of these patterns may occur if structures or objects are placed in the near or intermediate field of the antenna. The effect will be to distort the coverage patterns, adversely affecting range and link quality.

**Reflection.** Any object placed in line-of-sight of the transmit antenna will result in signals arriving at the receiver by an indirect path. Degradation of performance due to reflection (multipath effects) appears as reduced range or poor link quality.

Any of the above will reduce RSSI figures, an increase in the packet loss rate and in extreme cases complete loss of signal. Fortunately, if consideration is given to these effects at the integration stage then a good quality link will be obtained.

#### **Guidelines for product design:**

When selecting materials for product enclosures, preference should be given to fibreglass, light coloured ABS or Polypropylene (Dark colours can sometimes be achieved with the addition of carbon which can attenuate the radio signal); at the wavelength of 2.4GHz radio other materials will adversely affect the signal by attenuation, refraction or change in polarisation.

If the application demands that the radio is fitted inside a metal enclosure then ensure that the specified clearances are maintained around the antenna and design in a fibreglass RF window at least as large as the clearance dimensions but ideally as large as possible.

RA24i radios fitted inside a product should be oriented so that the chip antenna will be vertical when the product is in its normal operating position.

#### **Guidelines for installation:**

When planning installations ensure that line-of-sight between nodes is maintained and that objects or structures are kept at least one metre away from antennae wherever possible.

To avoid poor link quality between a RA24i radio and a handheld module ensure that the RA24i is mounted so that the chip antenna is vertical. Improvement may also be obtained by altering the height above ground of the RA24i; a small increase or reduction in antenna elevation will often improve reception.

Range underwater is only 100 mm or so depending on packet rate. Best performance underwater is obtained by using low packet rates and immersing water-proofed antennae rather than water-tight enclosures containing the antennae.

---

## Internal Chip Antenna (OEM Modules)

This is a helix type surface mount ceramic chip antenna.

Ideally the product enclosure should be made from fibreglass, light coloured ABS or Polypropylene; other materials will adversely affect the signal by attenuation, refraction or change in polarisation.



---

## Mounting

If the application demands that the radio is fitted inside a metal enclosure then ensure that the specified clearances are maintained around the antenna and design in a fibreglass RF window at least as large as the clearance dimensions but ideally as large as possible.

Radio modules fitted inside a product should be oriented so that the chip antenna will be vertical when the product is in its normal operating position.

There must be no metal objects within 7 mm of the antennas long edge and 20 mm from the short edges. See diagram below.

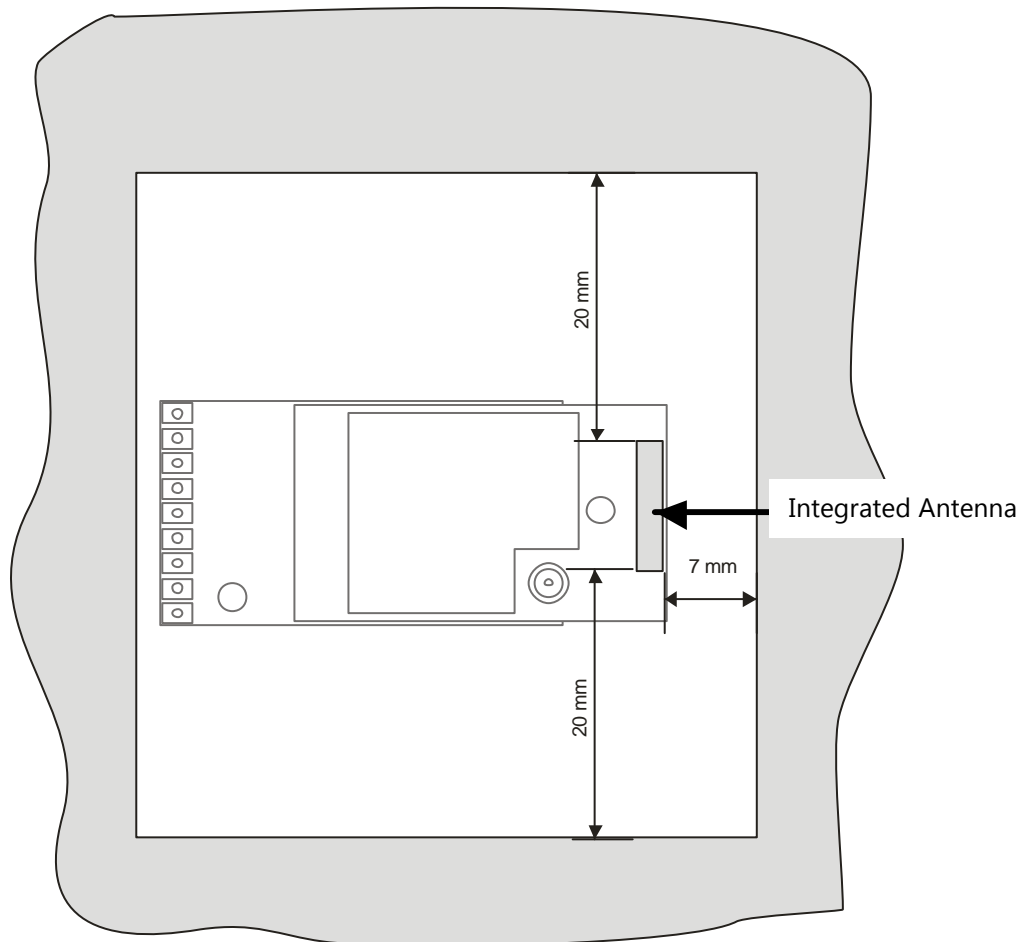

---

## Specification

**Gain:** 1.3dBi

**Type:** Ceramic chip antenna (Helix)

**Connection:** None



---

## T24-ANTA

This antenna is designed to be attached to a flat surface inside product enclosures made from plastic or fibre-glass. It is intended to be directly connected to the radio module.



---

## Mounting

Products containing this type of antenna should be oriented so that the antenna long axis is vertical during normal operation if possible. Antenna feeder cable should be arranged to lie along the ground plane section, allowing the feeder to run close to the active element will adversely affect performance. 100 mm UFL cable included.

The PCB requires 3.0 mm Clearance on all edges, this also applies to the RF window.

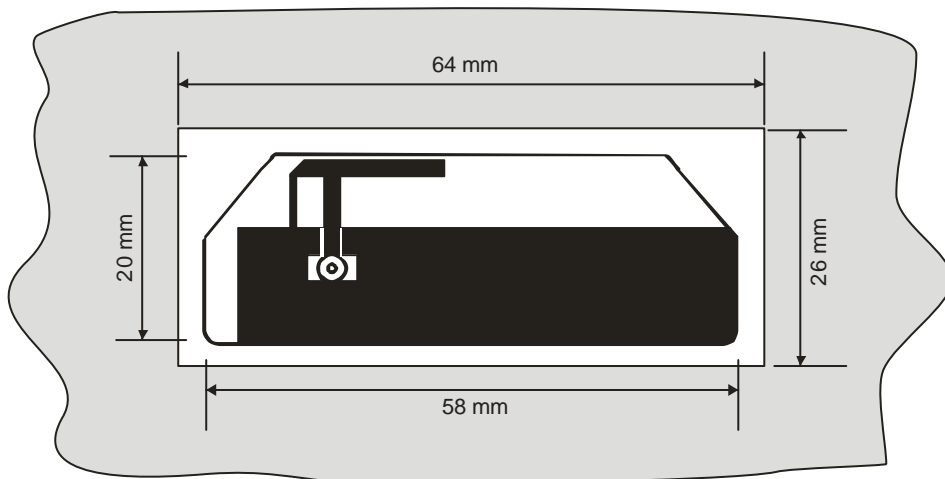

The antenna feeder cable, or any other cables or wires, must not be routed over or near the cross hatched area shown below as this will affect range.

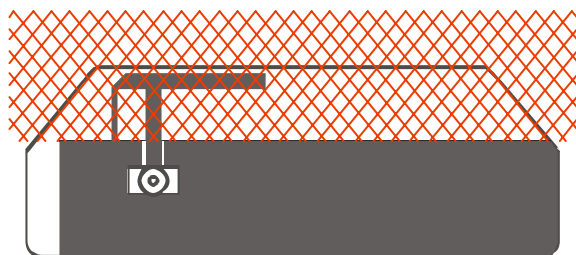

---

## Specification

**Gain:** 3.0dBi

**Type:** Inverted F Printed circuit antenna

**Connection:** 100 mm cable with UFL connector

---

## T24-ANTB

This weatherised omnidirectional antenna provides an antenna solution with a fixed right angle base and is fitted with a reverse polarity SMA connector. The antenna is supplied with a 100 mm reverse polarity SMA to UFL connector.

Intended to be fitted outside an enclosure where it will be attached to a bulkhead or chassis mounted RPSMA jack which is at one end of a pig-tail with a U.FL connector at the inner end for attachment to a radio module.

Alternatively, the RPSMA bulk-head jack could be at the end of a feeder extension used to facilitate mounting the antenna some distance from the product enclosure. Feeder extension length depends on the specific application but in general should not be more than two metres.

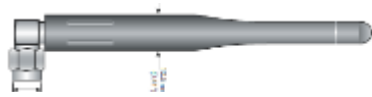

---

## Mounting

RPSMA bulk-head or chassis mounting jacks usually require a 6.4 mm diameter hole in the product enclosure or antenna mounting bracket. These antennae should be mounted so that the element is vertical and ideally at least one metre from large metal objects or structures.

The user must ensure that the bulkhead mounted connector is sealed to the required level.

---

## Specification

**Gain:** 1.1 dBi

**Type:** ½ wave dipole

**Connection:** Reverse polarity SMA connector on antenna to connect to reverse polarity SMA bulkhead on 100 mm tail to UFL connector.

---

## T24-ANTC

This weatherised omnidirectional antenna provides an antenna solution with an articulated base and is fitted with a reverse polarity SMA connector.

Intended to be fitted outside an enclosure where it will be attached to a bulkhead or chassis mounted RPSMA jack which is at one end of a pig-tail with a U.FL connector at the inner end for attachment to a radio module.

Alternatively, the RPSMA bulk-head jack could be at the end of a feeder extension used to facilitate mounting the antenna some distance from the product enclosure. Feeder extension length depends on the specific application but in general should not be more than two metres.



---

## Mounting

RPSMA bulk-head or chassis mounting jacks usually require a 6.4 mm diameter hole in the product enclosure or antenna mounting bracket. These antennae should be mounted so that the element is vertical and ideally at least one metre from large metal objects or structures.

The user must ensure that the bulkhead mounted connector is sealed to the required level.

---

## Specification

**Gain:** 2.2 dBi

**Type:** ½ wave dipole

**Connection:** Reverse polarity SMA connector on antenna to connect to reverse polarity SMA bulkhead on 100 mm tail to UFL connector.

---

## T24-ANTD

This option is intended for applications where the antenna must be mounted away from the radio module either on the outside of a large enclosure or equipment cabinet or on an external surface. It is fitted with a 600 mm long feeder terminated in a RPSMA plug.



---

### Mounting

Mounting requirements are a 10 mm diameter hole through a maximum material thickness of 3.0 mm if the nut and shake-proof washer are used, or thicker if the self-adhesive pad alone is used. It should be oriented so that the broad face points toward the remote device i.e. if it is to link to devices passing overhead then the broad face should be uppermost. Dimensions: 53 mm diameter, 19 mm puck height, 6mm stud length

---

### Specification

**Gain:** 3.0dBi

**Type:** Inverted F Printed circuit antenna

**Connection:** 1.0m cable terminated in reverse polarity SMA plug (RPSMA Plug)

---

## T24-ANTE

This surface mounting antenna provides a robust antenna solution and is fitted with a 100 mm UFL connector for direct connection to transmitter modules. This can be mounted on metal or plastic enclosures or bulkheads. This option is useful when the antenna is to be mounted close to the radio module.



---

### Mounting

Mounting requirements are a 10 mm diameter hole through a maximum material thickness of 3.0 mm if the nut and shake-proof washer are used, or thicker if the self-adhesive pad alone is used. It should be oriented so that the broad face points toward the remote device i.e. if it is to link to devices passing overhead then the broad face should be uppermost. Dimensions: 53 mm diameter, 19 mm puck height, 6mm stud length

---

### Specification





**Gain:** 3.0dBi

**Type:** Inverted F Printed circuit antenna









**Connection:** 60 mm cable terminated UFL plug

## Antenna Range

The following tables give the maximum range in an open field site between two T24 modules. Look up the T24 module to determine antenna type. Then refer to the grid below to find the achievable range between those two antenna types.

<b>Integrated Antenna</b>		T24-BSu, T24-SAi, T24-SAfi, T24-PAi, T24-RAi, T24-TAi, T24-ACMm-xx (Any transmitter modules housed in the <a href="#">ACMm enclosure</a> )
<b>T24-ANTA</b>		T24-BSue, T24-BS, T24-HS, T24-HA, T24-HR, T24-SO, T24-AO1i, T24-RM1, T24-LD1, T24-AR, T24-PR1, T24-GW1 T24-ACM-xx (Any transmitter module housed in the <a href="#">ACM enclosure</a> ) T24-ACMi-xx (Any transmitter module housed in the <a href="#">ACMi enclosure</a> ) Using this antenna on an OEM transmitter module with UFL socket
<b>T24-ANTB T24-ANTC</b>		Using either of these antennas on an OEM transmitter module with UFL socket
<b>T24-ANTD T24-ANTE</b>		Using either of these antennas on an OEM transmitter module with UFL socket

Then refer to the table below to find the achievable range between two antenna types.

		<b>Integrated Antenna</b>	<b>T24-ANTA</b>	<b>T24-ANTB T24-ANTC</b>	<b>T24-ANTD T24-ANTE</b>
					
<b>Integrated Antenna</b>		500m	600m	400m	600m
<b>T24-ANTA</b>		600m	800m	400m	800m
<b>T24-ANTB T24-ANTC</b>		400m	400m	400m	400m
<b>T24-ANTD T24-ANTE</b>		600m	800m	400m	800m

Tests conducted in an open field site with the transmitter at the top of a 3m pole. The receiver was mounted 1.5m off the ground.

---

## Appendix C - Radio Specification

The following specification applies to all T24 modules.

	Min	Typical	Max	Units
License		License Exempt		
Modulation method		MS (QPSK)		
Radio type		Transceiver (2 way)		
Data rate		250		K bits/sec
Radio Frequency	2.4000		2.4835	GHz
Power		10		mW
Channels (DSSS)		15		

For radio range information See [Appendix B – Antenna Range](#)

---

## Appendix D – Battery Selection

The following section applies to transmitter modules. Some enclosures will determine the battery type and size.

---

### Considerations When Selecting Batteries

---

#### Re-chargeable or replacement

This really depends on the application. Some applications where expected battery life with alkaline batteries will be many years would probably not warrant the use of re-chargeable batteries. Re-chargeable batteries have implementation issues such as how to connect to the charger, how to seal this connection if required, can the batteries be re-charged at a convenient point in the operation of the module i.e. between shifts and does the voltage, when charging, exceed the maximum supply voltage of the transmitter module if so the inline charging module will need to be fitted.

---

#### Required battery life

Driven by the application and mainly dependent on measurement rate and sample time. The operation would normally require that the transmitter module is used in Low Power Mode to maximise battery life.

---

#### Size of

Choosing a battery will be influenced by how much space is available and what battery life is required, generally the bigger the battery the longer it will last.

---

#### Operating temperature range

A battery's useable capacity is influenced by its operating temperature. Generally, the lower the temperature the lower their ability to provide charge. Beware of the batteries specified operating range when considering a particular battery technology.

---

#### Self-discharge.

Batteries are chemical devices and have a shelf life which needs to be considered in application where long battery life is required. Typically an Alkaline has a battery life of 5 years.

---

#### Internal Resistance of battery

Low internal resistance is important, the higher the resistance the less useful life of the battery is available. This is due to voltage drops caused during the high current phase of the measurement cycle. In the case of a T24-SAf strain gauge input module 300mA required for 250us. Batteries with an internal resistance greater than 150 milli ohm may require additional capacitor modules to supply the peak current.

---

#### Connections to battery

For the same reasons internal resistance must be low it is important to keep any voltage drops from the battery to the transmitter module as low as possible too. Care must be taken in selecting the connection method between batteries and transmitter module. For example cables should be kept as short and thick as possible. If sourcing battery holders for OEM transmitter modules be aware that some holders with springs only on one side of the battery can temporarily disconnect a battery when subjected to a shock force. This may have the unexpected effect of resetting or restarting a module. In the case of a transmitter module that is in a deep sleep mode this may wake the module.

---



For example, a transmitter module mounted aboard a vehicle may not achieve the calculated battery life because bumps in the road may have reset the module from its deep sleep mode. Utilising a **Sleep Delay** in transmitter modules will alleviate this issue by returning the modules to deep sleep after a period of inactivity.

---

## Environmental

Other considerations when selecting a connection method to the Batteries is the effect of vibration. A standard battery holder is a poor choice in applications when the module can be subject to vibration. This is due to the interruption of supply from the battery to the transmitter module caused when the spring arrangement holding the battery to the terminal of the holder is defeated.

Corrosion of terminals must also be considered as this will also introduce resistance into the supply connections. This could be overcome by ensuring the enclosure is sealed.

---

## Optimising battery life

Battery life can be optimised by considering the following:

- Use of low power mode.
- Transmission interval.
- Required Measurement resolution (Sample time).
- Sleep / Wake configuration
- Auto-Sleep duration.

---

## Battery Types

Battery Type	Notes
Lithium Iron Disulphide Li-FeS <sub>2</sub>	These can be found at 1.5 volts in AA size and can therefore be a direct replacement for Alkaline cells. The low internal resistance and high capacity make these batteries an ideal choice. The shelf life is around 20 years. Recommended for AA battery powered modules: <b>Energizer Ultimate Lithium L91</b>
Alkaline Zn-MnO <sub>2</sub>	Pairs of alkaline 1.5 V cells are the most common. Use D cells for maximum life and AA cells where space is restricted. Typical capacity is 2Ah. Example: Varta 4014 (D), Varta 4006 (AA)
Nickel Metal Hydride NiMh	Most cells are 1.2 V so two in series gives 2.4 V. These can match alkaline batteries in capacity but as the charged voltage is lower they do not match the usable capacity. These batteries self discharge at a faster rate than alkalines. If charging these cells in circuit precautions must be taken to ensure that the maximum voltage on the transmitter module is not exceeded. Example: GP 270AAHC (AA)
Nickel Cadmium NiCad	Most cells are 1.2 V so two in series gives 2.4 V. Three in series can be used to give 3.6 volts. These do not have the usable capacity of an alkaline battery. These are generally only useful if they are to be charged on a regular basis. If charging these cells in circuit precautions must be taken to ensure that the maximum voltage on the transmitter module is not exceeded.
Lithium Primary 3.6V Li-SOCl <sub>2</sub>	Lithium cells can be used but note that the maximum voltage is 3.6 V. Select a cell with low internal resistance. Example: Saft LS17500 (A), Saft LSH20 (D) <b>Recommend T24-BC1 module</b> as these cells usually have a high internal resistance.
Lithium Ion and Lithium Polymer Li ion, LiPo	These generally start at 3.7 V and exceed the maximum allowable voltage. These are usable if a regulator and charging circuit can be installed between the transmitter module and the battery. Care must be taken here that the regulator does not draw too much current when idle so that the low power modes are not compromised. <b>Recommend T24-BC1 module.</b>

---

## Appendix E – Approval Statements

---

CE



Complies with EMC directive. 2014/30/EU  
The Radio Equipment Directive, 2014/53/EU,

### **European Community, Switzerland, Norway, Iceland, and Liechtenstein**

- English: This equipment is in compliance with the essential requirements and other relevant provisions of Directive
- Deutsch: Dieses Gerät entspricht den grundlegenden Anforderungen und den weiteren entsprechenden Vorgaben der Richtlinie 2014/53/EU.
- Dansk: Dette udstyr er i overensstemmelse med de væsentlige krav og andre relevante bestemmelser i Direktiv 2014/53/EU.
- Español: Este equipo cumple con los requisitos esenciales así como con otras disposiciones de la Directiva 2014/53/EU.
- Français: Cet appareil est conforme aux exigences essentielles et aux autres dispositions pertinentes de la Directive 2014/53/EU.
- Íslenska: Þessi búnaður samrýmist lögboðnum kröfum og öðrum ákvæðum tilskipunar 2014/53/EU.
- Italiano: Questo apparato é conforme ai requisiti essenziali ed agli altri principi sanciti dalla Direttiva 2014/53/EU.
- Nederlands: Deze apparatuur voldoet aan de belangrijkste eisen en andere voorzieningen van richtlijn 2014/53/EU.
- Norsk: Dette utstyret er i samsvar med de grunnleggende krav og andre relevante bestemmelser i EU-direktiv 2014/53/EU.
- Português: Este equipamento satisfaz os requisitos essenciais e outras provisões da Directiva 2014/53/EU.
- Suomalainen: Tämä laite täyttää direktiivin 2014/53/EU oleelliset vaatimukset ja on siinä asetettujen muidenkin ehtojen mukainen.
- Svenska: Denna utrustning är i överensstämmelse med de väsentliga kraven och andra relevanta bestämmelser i Direktiv 2014/53/EU.

This equipment is in compliance with the essential requirements and other relevant provisions of Directive 2014/53/EU.

**Manufactured in the UK by: Mantracourt Electronics Ltd, The Drive, Farringdon, Exeter, Devon, EX5 2JB, UK**



### IC:7224A-RA24

This device complies with Industry Canada licence-exempt RSS standard(s). Operation is subject to the following two conditions: (1) this device may not cause interference, and (2) this device must accept any interference, including interference that may cause undesired operation of the device.

Under Industry Canada regulations, this radio transmitter may only operate using an antenna of a type and maximum (or lesser) gain approved for the transmitter by Industry Canada. To reduce potential radio interference to other users, the antenna type and its gain should be so chosen that the equivalent isotropically radiated power (e.i.r.p.) is not more than that necessary for successful communication.

This radio transmitter RA24 has been approved by Industry Canada to operate with the antenna types listed below with the maximum permissible gain and required antenna impedance for each antenna type indicated. Antenna types not included in this list, having a gain greater than the maximum gain indicated for that type, are strictly prohibited for use with this device.

Antenna	Gain (dBi)	Antenna Type	Manufacturer/Vendor
Ant A	3	Inverted F	Load Cell Central
Ant C	2.2	½ wave Dipole	Load Cell Central
Integrated	1.3	Chip antenna	Load Cell Central

**To comply with Industry Canada RF radiation exposure limits for general population, the antenna(s) used for this transmitter must be installed such that a minimum separation distance of 5 cm is maintained between the radiator (antenna) and all persons at all times and must not be co-located or operating in conjunction with any other antenna or transmitter.**



Family: RA24  
Models: i and e

#### FCC ID: VHARA24

- This device complies with Part 15 of the FCC Rules. Operation is subject to the following two conditions:  
(1) This device may not cause harmful interference, and  
(2) This device must accept any interference received, including interference that may cause undesired operation.
- This equipment complies with FCC radiation exposure limits set forth for an uncontrolled environment. End users must follow the specific operating instructions for satisfying RF exposure compliance. This transmitter must not be co-located or operating in conjunction with any other antenna or transmitter.
- Changes or modifications not expressly approved by the party responsible for compliance could void the user's authority to operate the equipment

For use with antennas: integrated, T24-ANTA, T24-ANTB, T24-ANTC, T24-ANTD, T24-ANTE antennas and those listed in the table below.

Manufacturer Code	Description	Gain	Available From
DELTA7A	Dual band 2.4 or 5.8GHz Hinged mount whip	2.1dBi	Sequoia
DELTA14	Stubby WiFi / WLAN Antenna	2.0dBi	Sequoia
DELTA15/SMAM/RA/RP11	2.4GHz Right angle RPSMA	2.0dBi	Sequoia
1699481	AUREL ANT.RP SMA 2.4GHz	2.0dBi	Farnell Electronic Components
537-785	EAD, FBKR35068-RS-KR WiFi Antenna	2.0dBi	RS Components

---

## Appendix F - OEM / Reseller Marking and Documentation Requirements

---

### CE

The T24 series has been certified for several European countries.

If the transmitter module is incorporated into a product, the manufacturer must ensure compliance of the final product to the European harmonized EMC and low-voltage/safety standards. A Declaration of Conformity must be issued for each of these standards and kept on file as described in Annex II of the R&TTE Directive.

Furthermore, the manufacturer must maintain a copy of the T24 device user manual documentation and ensure the final product does not exceed the specified power ratings, antenna specifications, and/or installation requirements as specified in the user manual. If any of these specifications are exceeded in the final product, a submission must be made to a notified body for compliance testing to all required standards.

#### **OEM Labelling Requirements**

The 'CE' marking must be affixed to a visible location on the OEM product.

The CE mark shall consist of the initials "CE" taking the following form:

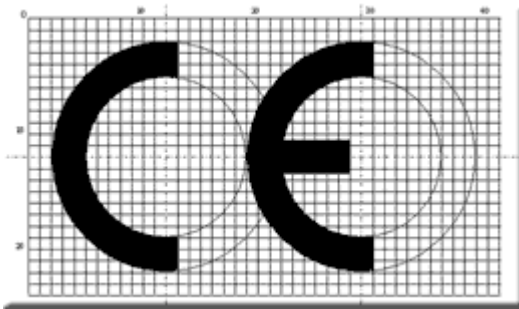

- If the CE marking is reduced or enlarged, the proportions given in the above drawing must be respected.
- The CE marking must have a height of at least 5 mm except where this is not possible on account of the nature of the apparatus.
- The CE marking must be affixed visibly, legibly, and indelibly.

---

## IC

The RA24 Module has been certified for integration into products only by OEM integrators under the following conditions:

1. The antenna(s) must be installed such that a minimum separation distance of 5cm is maintained between the radiator (antenna) and all persons at all times.
2. The transmitter module must not be co-located or operating in conjunction with any other antenna or transmitter.

As long as the two conditions above are met, further transmitter testing will not be required. However, the OEM integrator is still responsible for testing their end-product for any additional compliance requirements required with this module installed (for example, digital device emissions, PC peripheral requirements, etc.).

**IMPORTANT NOTE:** In the event that these conditions cannot be met (for certain configurations or co-location with another transmitter), then Industry Canada certification is no longer considered valid and the IC Certification Number cannot be used on the final product. In these circumstances, the OEM integrator will be responsible for re-evaluating the end product (including the transmitter) and obtaining a separate Industry Canada authorization.

### End Product Labelling

The RA24 Module is labelled with its own IC Certification Number. If the IC Certification Number is not visible when the module is installed inside another device, then the outside of the device into which the module is installed must also display a label referring to the enclosed module. In that case, the final end product must be labelled in a visible area with the following:

Contains Model RA24 Radio (2.4 GHz), IC:7224A-RA24

The OEM of the RA24 Module must only use the approved antenna(s) listed above, which have been certified with this module.

The OEM integrator has to be aware not to provide information to the end user regarding how to install or remove this RF module or change RF related parameters in the user's manual of the end product.

The user's manual for the end product must include the following information in a prominent location:

**“To comply with Industry Canada RF radiation exposure limits for general population, the antenna(s) used for this transmitter must be installed such that a minimum separation distance of 5 cm is maintained between the radiator (antenna) and all persons at all times and must not be co-located or operating in conjunction with any other antenna or transmitter.”**

## FCC

The Original Equipment Manufacturer (OEM) must ensure that FCC labelling requirements are met. This includes a clearly visible label on the outside of the final product enclosure that displays the contents as shown:

Contains FCC ID:VHARA24

- This device complies with Part 15 of the FCC Rules.  
Operation is subject to the following two conditions:  
(1) This device may not cause harmful interference, and  
(2) This device must accept any interference received, including interference that may cause undesired operation.
- This equipment complies with FCC radiation exposure limits set forth for an uncontrolled environment. End users must follow the specific operating instructions for satisfying RF exposure compliance. This transmitter must not be co-located or operating in conjunction with any other antenna or transmitter.
- Changes or modifications not expressly approved by the party responsible for compliance could void the user's authority to operate the equipment

When integrated in OEM products, fixed antennas require installation preventing end-users from replacing them with non-approved antennas. Antennas other than T24-ANTA, T24-ANTB, T24-ANTC, T24-ANTD, T24-ANTE and those listed below, must be tested to comply with FCC Section 15.203 (unique antenna connectors) and Section 15.247 (emissions).

Manufacturer Code	Description	Gain	Available From
DELTA7A	Dual band 2.4 or 5.8GHz Hinged mount whip	2.1dBi	Sequoia
DELTA14	Stubby WiFi / WLAN Antenna	2.0dBi	Sequoia
DELTA15/SMAM/RA/RP11	2.4GHz Right angle RPSMA	2.0dBi	Sequoia
1699481	AUREL ANT.RP SMA 2.4GHz	2.0dBi	Farnell Electronic Components
537-785	EAD, FBKR35068-RS-KR WiFi Antenna	2.0dBi	RS Components

Transmitter modules have been certified by the FCC for use with other products without any further certification (as per FCC section 2.1091). Changes or modifications not expressly approved by Mantracourt could void the user's authority to operate the equipment.

In order to fulfil the certification requirements, the OEM must comply with FCC regulations:

1. The system integrator must ensure that the text on the external label provided with this device is placed on the outside of the final product.
2. The transmitter modules with external antennas may be used only with Approved Antennas that have been tested by Mantracourt.



---

## Appendix G - Worldwide Regional Approvals

<b>Region</b>	<b>Product Conforms To</b>
Europe	CE
USA	FCC
Canada	IC

---

### Important Note

Mantracourt does not list the entire set of standards that must be met for each country. Mantracourt customers assume full responsibility for learning and meeting the required guidelines for each country in their distribution market.

For more information relating to European compliance of an OEM product incorporating the T24 range of modules, contact Mantracourt, or refer to the following web site: **[www.ero.dk](http://www.ero.dk)**

## EU DECLARATION OF CONFORMITY

We, the undersigned:

Name of Manufacturer:

**Mantracourt Electronics Ltd**

Address:

**The Drive, Farrington, Exeter,**

**Devon, EX5 2JB**

Country:

**United Kingdom**

Declare under our sole responsibility that the **T24 Telemetry Product Range** is in conformity with the following relevant Union harmonisation legislation:

**LVD Directive 2014/35/EU**

**EMC Directive 2014/30/EU**

**RoHS Directive 2011/65/EU**

**Radio Equipment Directive 2014/53/EU**

Based on the following harmonised standards:

**EN 61326-1:2013**

**EN 61326-2-3:2013**

**EN 61010-1:2010**

**EN 300328 V1.9.1**

Name and position of person binding the manufacturer or authorised representative:

Signed

Name:

**Robert Willmington-Badcock**

Function:

**Managing Director**

Location:

**Mantracourt Electronics Ltd**

Date of issue:

**25<sup>th</sup> April 2016**



FCC ID: VHARA24

IC:7224A-RA24



**ME mantracourt**

Mantracourt Electronics Ltd  
The Drive, Farringdon  
Exeter, Devon EX5 2JB  
United Kingdom

Tel: +44(0) 1395 232020  
Fax: +44(0) 1395 233190  
info@mantracourt.com  
mantracourt.com

### Warranty

All Telemetry products from Mantracourt Electronics Ltd., ('Mantracourt') are warranted against defective material and workmanship for a period of one (1) year from the date of dispatch.

If the 'Mantracourt' product you purchase appears to have a defect in material or workmanship or fails during normal use within the period, please contact your Distributor, who will assist you in resolving the problem. If it is necessary to return the product to 'Mantracourt' please include a note stating name, company, address, phone number and a detailed description of the problem. Also, please indicate if it is a warranty repair.

The sender is responsible for shipping charges, freight insurance and proper packaging to prevent breakage in transit.

'Mantracourt' warranty does not apply to defects resulting from action of the buyer such as mishandling, improper interfacing, operation outside of design limits, improper repair or unauthorised modification.

No other warranties are expressed or implied. 'Mantracourt' specifically disclaims any implied warranties of merchantability or fitness for a specific purpose.

The remedies outlined above are the buyer's only remedies. 'Mantracourt' will not be liable for direct, indirect, special, incidental or consequential damages whether based on the contract, tort or other legal theory.

Any corrective maintenance required after the warranty period should be performed by 'Mantracourt' approved personnel only.

  
Advanced Intelligent Instrumentation

Document Title: **T24 Telemetry User Manual**  
Applies To: **T24 Product Range**  
Part Number: **517-937**  
Issue Number: **01.03**  
Dated: **25<sup>th</sup> November 2016**



Load Cell Central follows a policy of continuous improvement and reserves the right to change specifications without notice. © 2016

**Load Cell Central**  
28175 Route 220  
Milan, PA 18831

Web: [www.800loadcel.com](http://www.800loadcel.com)  
Email: [sales@800loadcel.com](mailto:sales@800loadcel.com)

**Toll Free: 1-800-562-3235**  
Ph: 1-570-731-7048  
Fax: 1-570-731-7054